



**City of Santa Barbara**

# **Storm Water BMP Guidance Manual**

---

July 2013  
(Final)

THIS PAGE INTENTIONALLY LEFT BLANK



engineers | scientists | innovators

**Table of Contents**

**1 Introduction .....1-1**

    1.1 Purpose of the Manual ..... 1-1

    1.2 Background..... 1-3

        1.2.1 Storm Water Management & LID Concepts..... 1-3

        1.2.2 Benefits of Storm Water Management..... 1-4

        1.2.3 Federal and State Storm water Regulations ..... 1-5

        1.2.4 Storm Water Management Plan/Program Requirements (Local Storm Water Regulations) ..... 1-6

        1.2.5 Local/Regional Coordination & Communication..... 1-6

    1.3 City of Santa Barbara Post-Construction Storm Water Management Requirements (as defined in the SWMP) ..... 1-7

    1.4 Project Tiers ..... 1-8

        1.4.1 Requirements by Tier ..... 1-8

    1.5 How to Use This Manual..... 1-11

**2 Site Assessment and BMP Selection .....2-1**

    2.1 Assessing Site Conditions and Other Constraints..... 2-1

    2.2 Assessing Pollutants of Concern ..... 2-2

    2.3 BMP Selection Process..... 2-5

**3 Site Soil and Infiltration Assessment .....3-1**

    3.1 Who Should Conduct the Assessment?..... 3-1

    3.2 Preliminary Site Investigation..... 3-1

    3.3 Test Pit Investigation ..... 3-1

    3.4 Infiltration Tests ..... 3-3

    3.5 Falling-Head Infiltration Testing Procedure..... 3-3

    3.6 Laboratory Soil Tests ..... 3-4

**4 Site Design BMP Options.....4-1**

    4.1 Introduction ..... 4-1

        4.1.1 Goals and Objectives..... 4-1

    4.2 Conserve and Restore Natural Areas..... 4-2

    4.3 Maintain, Restore and Utilize Natural Flow Paths ..... 4-3

    4.4 Site BMPs on Infiltrative Soils ..... 4-4

    4.5 Minimize Soil Disturbance and Compaction ..... 4-4

    4.6 Minimize Impervious Surfaces ..... 4-5

    4.7 Disconnect Impervious Surfaces and Utilize Pervious Areas..... 4-8

    4.8 Site Design Examples ..... 4-9

|  |            |
|--|------------|
| 4.8.1 Single-Family Residential .....  | 4-10       |
| 4.8.2 Multi-Family Residential .....   | 4-12       |
| 4.8.3 Commercial Development .....   | 4-14       |
| 4.8.4 Office Building .....  | 4-16       |
| 4.8.5 Residential Street .....   | 4-18       |
| <b>5 Basic BMP Options .....</b>   | <b>5-1</b> |
| 5.1 How to Choose Basic BMPs .....   | 5-1        |
| 5.2 Site Assessment (recommended for Tiers 1 and 2; this assessment is NOT intended for Tier 3 projects) ..... | 5-2        |
| 5.2.1 Soil Assessment .....  | 5-2        |
| 5.2.2 Simple Infiltration Test .....   | 5-3        |
| 5.2.3 Simple Texture by Feel Test .....  | 5-3        |
| 5.2.4 Site Slope Assessment .....  | 5-4        |
| 5.2.5 Roof Area Assessment .....   | 5-6        |
| 5.3 Disconnect Downspouts .....  | 5-9        |
| 5.4 Flow Spreading .....   | 5-13       |
| 5.5 Rainwater Gardens .....  | 5-15       |
| 5.6 Rain Barrels .....   | 5-20       |
| 5.7 Contained Planters .....   | 5-23       |
| 5.8 Depression Storage .....   | 5-25       |
| 5.9 Permeable Pavement for Single-Family Residences .....  | 5-27       |
| 5.10 Soil Amendments .....   | 5-29       |
| 5.11 Ribbon Driveways .....  | 5-31       |
| 5.12 Landscaping Considerations .....  | 5-33       |
| <b>6 STORMWATER RUNOFF BMP OPTIONS .....</b>   | <b>6-1</b> |
| 6.1 General Considerations .....   | 6-1        |
| 6.2 Stormwater Runoff Requirements For BMP Sizing .....  | 6-1        |
| 6.2.1 Peak Runoff Discharge Rate Requirement .....   | 6-2        |
| 6.2.2 Volume Reduction Requirement .....   | 6-2        |
| 6.2.3 Water Quality Treatment Requirements .....   | 6-3        |
| 6.2.4 Meeting Stormwater Runoff Requirements Simultaneously .....  | 6-3        |
| 6.3 BMP Selection Process .....  | 6-3        |
| 6.4 Waivers For Storm Water Runoff BMP Requirements .....  | 6-4        |
| 6.5 Suggested Strategies For Meeting The Storm Water Runoff Requirements .....                                 | 6-7        |
| 6.6 Biofiltration And Filtration BMPs .....  | 6-9        |
| 6.6.1 Bioretention .....   | 6-9        |
| 6.6.2 Vegetated Swale Filter .....   | 6-30       |
| 6.6.3 Vegetated Filter Strip .....   | 6-55       |
| 6.6.4 Sand Filter .....  | 6-69       |

|            |  |       |
|------------|--|-------|
| 6.7        | Infiltration BMPs.....   | 6-85  |
| 6.8        | Permeable Pavement BMPs .....  | 6-106 |
| 6.9        | Building BMPs .....  | 6-124 |
| 6.9.1      | Cistern/Rain barrel.....   | 6-124 |
| 6.9.2      | Planter Box.....   | 6-128 |
| 6.9.3      | Green Roof.....  | 6-142 |
| 6.10       | Retention And Detention BMPs.....                                    | 6-149 |
| 6.10.1     | Constructed Treatment Wetland .....                                  | 6-149 |
| 6.10.2     | Wet Retention Basins .....   | 6-167 |
| 6.10.3     | Dry Extended Detention Basins .....                                  | 6-189 |
| 6.11       | Proprietary Devices.....   | 6-214 |
| 7          | REFERENCES.....  | 7-1   |
| Appendix A | Glossary Of Terms .....  | A-1   |
| Appendix B | Site Conditions Maps .....   | B-1   |
| Appendix C | BMP Sizing Methodologies .....                                       | C-1   |
| Appendix D | BMP Design Examples .....  | D-1   |
| Appendix E | Basin Outlet Sizing Examples .....                                   | E-1   |
| Appendix F | Flow Splitter Design Specifications .....                            | F-1   |
| Appendix G | Local Plant List.....  | G-1   |
| Appendix H | Facility Inspection And Maintenance Checklists .....                 | H-1   |
| Appendix I | Example Agreements, Forms, And Letters .....                         | I-1   |
| Appendix J | List Of Discretionary Projects Exempt From Tier 3 Requirements ..... | J-1   |
| Appendix K | DART SWMP Checklist.....   | K-1   |

**List of Tables**

Table 1-1: Post-Construction Project Tiers ..... 1-10

Table 2-1: Typical Site Assessment Information ..... 2-1

Table 2-2: Pollutants of Concern Based on Land Use ..... 2-3

Table 2-3: 303(d) Listed (2006) Water Bodies and Associated Pollutants ..... 2-5

Table 5-1: Matrix Table for Comparison of Basic BMP Options ..... 5-2

Table 5-2: Sizing factors for Rainwater Gardens (*modified from Bannerman, 2003*) ..... 5-17

Table 5-3: Soil Amendments and Their Specifications ..... 5-29

Table 5-4: Landscaping Plants and Associated Local Costs ..... 5-34

Table 6-1: BMP Selection Matrix – Pollutants of Concern ..... 6-5

Table 6-2: BMP Selection Matrix - Site Suitability ..... 6-6

Table 6-3: Volume Reduction & Treatment Effectiveness for Bioretention Areas ..... 6-10

Table 6-4: Site Suitability Considerations for Bioretention Areas ..... 6-11

Table 6-5: Applicability of Bioretention Areas for Special Design Districts ..... 6-12

Table 6-6: Bioretention Area Design Criteria ..... 6-13

Table 6-7: Bioretention Maintenance Quick Guide ..... 6-27

Table 6-8: Routine Maintenance – Bioretention ..... 6-28

Table 6-9: Major Maintenance – Bioretention ..... 6-29

Table 6-10: Volume Reduction & Treatment Effectiveness for Vegetated Swale Filters ..... 6-32

Table 6-11: Site Suitability Considerations for Vegetated Swale Filters ..... 6-32

Table 6-12: Applicability of Vegetated Swale Filters for Special Design Districts ..... 6-33

Table 6-13: Vegetated Swale Filter Design Criteria ..... 6-34

Table 6-14: Vegetated Swale Filter Maintenance Quick Guide ..... 6-51

Table 6-15: Routine Maintenance Standards - Vegetated Swale Filters ..... 6-52

Table 6-16: Major Maintenance Standards - Vegetated Swale Filters ..... 6-53

Table 6-17: Volume Reduction & Treatment Effectiveness for Vegetated Filter Strips ..... 6-56

Table 6-18: Site Suitability Considerations for Vegetated Filter Strips ..... 6-56

Table 6-19: Applicability of Vegetated Filter Strips for Special Design Districts ..... 6-57

Table 6-20: Vegetated Filter Strip Design Criteria ..... 6-58

Table 6-21: Vegetated Filter Strip Maintenance Quick Guide ..... 6-66

Table 6-22: Routine Maintenance – Vegetated Filter Strips ..... 6-67

Table 6-23: Major Maintenance – Vegetated Filter Strips ..... 6-68

Table 6-24: Volume Reduction & Treatment Effectiveness for Sand Filters ..... 6-71

Table 6-25: Site Suitability Considerations for Sand Filters ..... 6-71

Table 6-26: Applicability of Sand Filters for Special Design Districts ..... 6-71

Table 6-27: Sand Filter Design Criteria ..... 6-73

Table 6-28: Sand Filter Maintenance Quick Guide ..... 6-82

Table 6-29: Routine Maintenance – Sand Filters ..... 6-83

Table 6-30: Major Maintenance – Sand Filters ..... 6-84

Table 6-31: Volume Reduction & Treatment Effectiveness for Infiltration BMPs ..... 6-86

Table 6-32: Site Suitability Considerations for Infiltration BMPs ..... 6-87

Table 6-33: Applicability of Infiltration BMPs for Special Design Districts ..... 6-87

Table 6-34: Infiltration BMP Design Criteria ..... 6-89

Table 6-35: Infiltration BMP Maintenance Quick Guide ..... 6-103

Table 6-36: Routine Maintenance – Infiltration BMPs ..... 6-104

Table 6-37: Major Maintenance – Infiltration BMPs ..... 6-105

Table 6-38: Volume Reduction & Treatment Effectiveness for Permeable Pavement ..... 6-108

Table 6-39: Site Suitability Considerations for Permeable Pavement ..... 6-109

Table 6-40: Applicability of Permeable Pavement for Special Design Districts ..... 6-109

|   |       |
|---|-------|
| Table 6-41: Permeable Pavement Design Criteria .....                                  | 6-111 |
| Table 6-42: Permeable Pavement Maintenance Quick Guide.....                           | 6-121 |
| Table 6-43: Routine Maintenance – Permeable Pavement.....                             | 6-121 |
| Table 6-44: Major Maintenance – Permeable Pavement.....                               | 6-123 |
| Table 6-45: Site Suitability Considerations for Cisterns.....                         | 6-125 |
| Table 6-46: Applicability of Cisterns for Special Design Districts.....               | 6-125 |
| Table 6-47: Cistern Maintenance Quick Guide .....                                     | 6-127 |
| Table 6-48: Site Suitability Considerations for Planter Boxes.....                    | 6-129 |
| Table 6-49: Applicability of Planter Boxes for Special Design Districts.....          | 6-129 |
| Table 6-50: Planter Box Design Criteria .....   | 6-130 |
| Table 6-51: Planter Box Maintenance Quick Guide.....                                  | 6-139 |
| Table 6-52: Routine Maintenance – Planter Boxes .....                                 | 6-140 |
| Table 6-53: Major Maintenance – Planter boxes .....                                   | 6-141 |
| Table 6-54: Site Suitability Considerations for Green Roofs.....                      | 6-143 |
| Table 6-55: Applicability of Planter Boxes for Special Design Districts.....          | 6-143 |
| Table 6-56: Green Roof Design Criteria .....  | 6-144 |
| Table 6-57: Green Roofs Maintenance Quick Guide .....                                 | 6-148 |
| Table 6-58: Volume Reduction & Treatment Effectiveness for Treatment Wetland .....    | 6-151 |
| Table 6-59: Site Suitability Considerations for Treatment Wetlands .....              | 6-152 |
| Table 6-60: Applicability of Treatment Wetlands for Special Design Districts .....    | 6-152 |
| Table 6-61: Treatment Wetland Design Criteria.....                                    | 6-153 |
| Table 6-62: Treatment Wetland Maintenance Quick Guide.....                            | 6-163 |
| Table 6-63: Routine Maintenance Standards – Treatment Wetlands .....                  | 6-164 |
| Table 6-64: Major Maintenance Standards – Treatment Wetlands .....                    | 6-165 |
| Table 6-65: Volume Reduction & Treatment Effectiveness for Wet Retention Basins ..... | 6-169 |
| Table 6-66: Site Suitability Considerations for Wet Retention Basins .....            | 6-169 |
| Table 6-67: Applicability of Wet Retention Basins for Special Design Districts.....   | 6-170 |
| Table 6-68: Wet Retention Basin Design Criteria .....                                 | 6-171 |
| Table 6-69: Wet Retention Basin Maintenance Quick Guide .....                         | 6-185 |
| Table 6-70: Routine Maintenance Standards – Wet Retention Basin .....                 | 6-186 |
| Table 6-71: Major Maintenance Standards – Wet Retention Basin .....                   | 6-187 |
| Table 6-72: Volume Reduction & Treatment Effectiveness for Dry ED Basins .....        | 6-190 |
| Table 6-73: Site Suitability Considerations for Dry Extended Detention Basins.....    | 6-191 |
| Table 6-74: Applicability of Dry ED Basins for Special Design Districts.....          | 6-191 |
| Table 6-75: Dry Extended Detention Basin Design Criteria .....                        | 6-193 |
| Table 6-76: Dry Extended Detention Basin Maintenance Quick Guide .....                | 6-210 |
| Table 6-77: Routine Maintenance Standards - Extended Detention Basins.....            | 6-211 |
| Table 6-78: Major Maintenance Standards - Extended Detention Basins.....              | 6-212 |
| Table 6-79: Proprietary Device Manufacturer Websites .....                            | 6-220 |

List of Figures

Figure 1-1: Manual Flowchart Based on Project Tier.....1-2

Figure 3-1: Post-fill Soil Profile.....3-2

Figure 4-1: Example of Soil Disturbance Minimization.....4-4

Figure 4-2: Example of Minimizing Impervious Surfaces by Implementing Bioretention in a Parking Lot.....4-5

Figure 4-3: Example of Minimizing Impervious Surfaces in a Parking Lot.....4-6

Figure 4-4: Disconnected Downspout Directed to a Pervious Area.....4-8

Figure 4-5: Single-Family Site Design Example.....4-11

Figure 4-6: Multi-Family Residential Site Design Example.....4-13

Figure 4-7: Commercial Site Design Example.....4-15

Figure 4-8: Office Building Site Design Example.....4-17

Figure 4-9: Residential Street Design Example.....4-18

Figure 5-1: Example of disconnected downspout that directs runoff to pervious area.....5-9

Figure 5-2: Flow Spreading - Directing Runoff from a Disconnected Downspout Away From a Foundation (University of California, Santa Barbara).....5-13

Figure 5-3: Rainwater Garden Implemented in the Front Yard of a Single-Family Santa Barbara Residence.....5-15

Figure 5-4: Rain Barrel Blends Into Surroundings.....5-20

Figure 5-5: Contained Planters With Trees and Flowers.....5-23

Figure 5-6: Depression Storage.....5-25

Figure 5-7: Typical Permeable Pavement Cross-Section.....5-27

Figure 5-8: Permeable Pavers in a Driveway in Front of a Single-Family Residence in Santa Barbara.....5-27

Figure 5-9: Grass Paver Blocks in a Residential Driveway.....5-28

Figure 5-10: Gravelpave<sup>2</sup>.....5-28

Figure 5-11: Soil amended area at U.S. EPA Ariel Rios Building.....5-29

Figure 5-12: Ribbon Driveway.....5-31

Figure 5-13: Ribbon Driveway.....5-31

Figure 5-14: Local Landscaping.....5-33

Figure 6-1: Bioretention Area – Arroyo Burro.....6-9

Figure 6-2: Bioretention Area Schematic.....6-25

Figure 6-3: Roadside Swale.....6-30

Figure 6-4: Trapezoidal Channel Capacity Chart.....6-39

Figure 6-5: Vegetated Swale Filter Schematic.....6-48

Figure 6-6: Flow Spreader and Check Dam Schematics.....6-49

Figure 6-7: Vegetated Filter Strip Providing Pretreatment for a Bioretention Area.....6-55

Figure 6-8: Vegetated Filter Strip Schematic.....6-64

Figure 6-9: Volleyball Court Sand Filter.....6-69

Figure 6-10: Sand Filter Schematic.....6-81

Figure 6-11: Infiltration Basin.....6-85

Figure 6-12: Infiltration Basin Schematic.....6-98

Figure 6-13: Infiltration Trench Schematic.....6-99

Figure 6-14: Dry Well Schematic.....6-100

Figure 6-15: Permeable Pavers.....6-106

Figure 6-16: Permeable Pavement Schematic.....6-119

Figure 6-17: Typical Above Ground Cistern.....6-124

Figure 6-18: Planter Box.....6-128

Figure 6-19: Planter Box Schematic.....6-137

Figure 6-20: Typical Cross Section of a Green Roof.....6-142

Figure 6-21: Constructed Treatment Wetland at University of California, Santa Barbara.....6-149

Figure 6-22: Constructed Treatment Wetland Schematic.....6-161



Figure 6-23: Wet Retention Basin with Vegetation Along Perimeter ..... 6-167  
Figure 6-24: Wet Retention Basin Schematic ..... 6-181  
Figure 6-25: Riser Outlet Schematic – Option 1 ..... 6-182  
Figure 6-26: Inverted Pipe Outlet Schematic – Option 2 ..... 6-183  
Figure 6-27: Dry ED Basin (dual use; playing field when dry) ..... 6-189  
Figure 6-28: Dry Extended Detention Basin Schematic ..... 6-203  
Figure 6-29: Perforated Riser Outlet Schematic – Option 1 ..... 6-204  
Figure 6-30: Perforated Riser Outlet Schematic – Option 2 ..... 6-205  
Figure 6-31: Multiple Orifice Outlet Schematic – Option 3 ..... 6-206  
Figure 6-32: Emergency Spillway Schematic ..... 6-207  
Figure 6-33: Filterra Tree Box Filter ..... 6-214

# 1 INTRODUCTION

## 1.1 Purpose of the Manual

Under most existing conditions, storm water runoff from urban areas picks up pollutants as it flows across roofs, sidewalks, driveways and streets, and then is conveyed by gutters, channels, and storm drains directly to local creeks and the Ocean, without any treatment. This runoff carries sediment, nutrients, bacteria, hydrocarbons, metals, pesticides, and trash. Urban storm water runoff is the single largest source of surface water pollution in Santa Barbara.

The City of Santa Barbara's Storm Water Management Plan/Program (SWMP) is in place to reduce the discharge of non-point source pollutants into local creeks and the Ocean. (See [http://www.santabarbaraca.gov/Resident/Community/Creeks/Storm\\_Water\\_Management\\_Program.htm](http://www.santabarbaraca.gov/Resident/Community/Creeks/Storm_Water_Management_Program.htm)). As called for in the SWMP, City staff have produced this Guidance Manual (Manual) to provide assistance in meeting existing post-construction storm water management standards for new development and redevelopment. Specifically, the Manual assists project applicants in the selection, integration, design, and implementation of a variety of storm water Best Management Practice (BMP) options for a project site. In general, a project "site" is defined by the parcel boundaries. The Manual identifies and describes a range of BMPs including rain barrels, bioswales, and infiltration basins, that are designed to capture and treat storm water runoff from development and redevelopment projects.

**It is important to emphasize that the Manual is not exclusive in its presentation of BMP options. The purpose of the Manual is to describe a broad range of storm water BMPs that are appropriate for implementation in the City of Santa Barbara. However, it is possible for a project applicant to propose a storm water BMP option that is not included in this Manual, as long as it meets the requirements specifically outlined in the City's SWMP (described again in Section 6.2 of this Manual).**

The goal of both the SWMP and the Manual is to provide strategies and guidelines for the protection of water quality and reduction of non-point source pollutant discharges within the City to the Maximum Extent Practicable (MEP). This goal can be met by preventing and controlling the impacts of development, which increases storm water runoff volume, velocity, and pollution, using a sensible combination of pollutant source control, site design, and post-construction storm water runoff BMPs. This Manual assists projects in achieving these goals by providing tailored guidance to two specific audiences:

1. Developers, design engineers, agency engineers, planners, landscape architects, and other storm water professionals, and
2. Residential property owners.

For each audience, this Manual guides the user in the selection, integration, design, and implementation of a variety of BMP options for a project site to meet the City of Santa Barbara post-construction storm water management requirements for development and redevelopment projects. The following flowchart (Figure 1-1) identifies which chapters of the Manual are required to be implemented based on your project type. Project types are divided into three project tiers (Tier 1, Tier 2, and Tier 3). In addition to Figure 1-1, refer to Table 1-1 and associated text in Section 1.3 to identify the project tier. Note that solid arrows in the flowchart indicate required implementation while dashed lines indicate voluntary implementation.

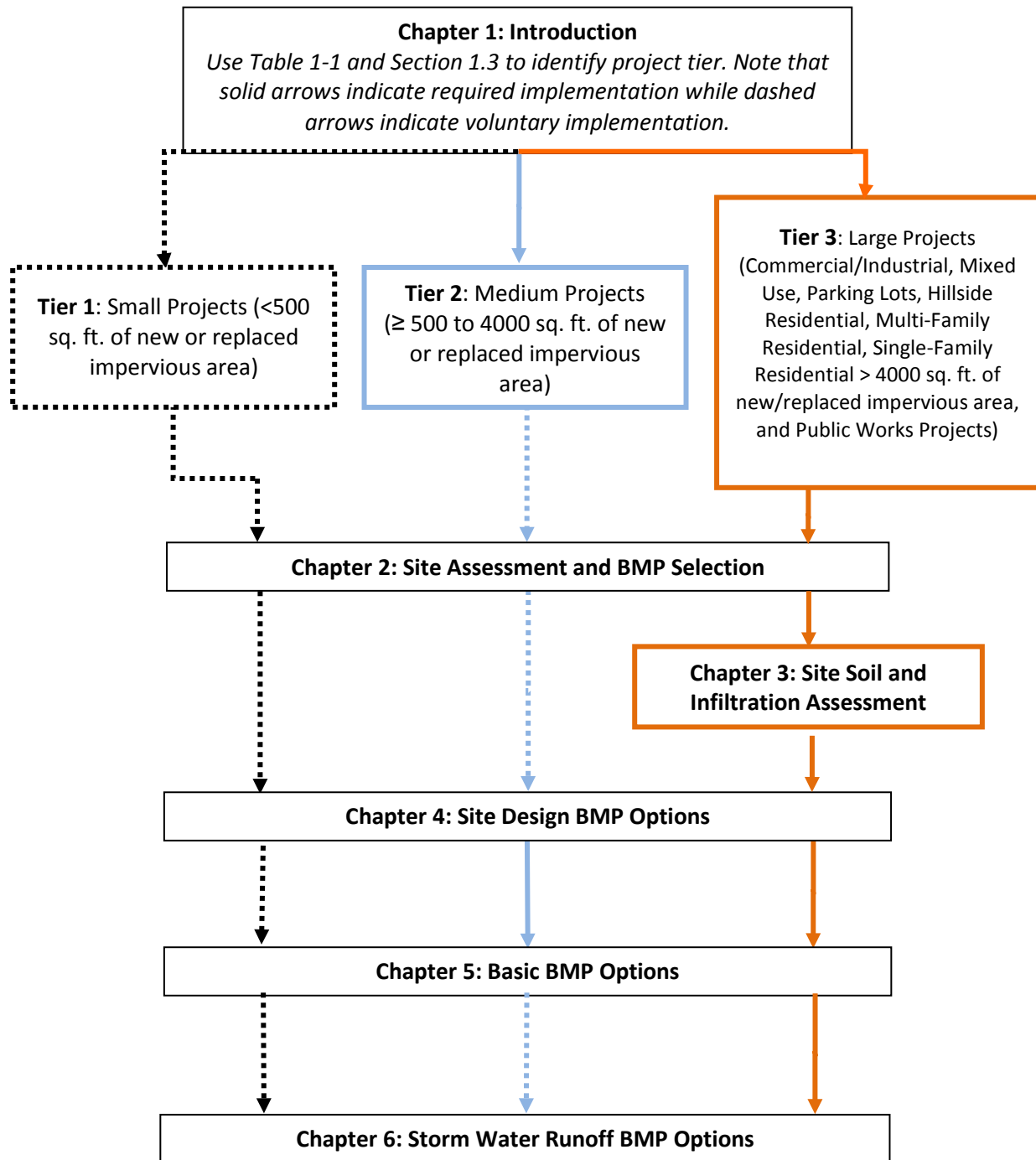

Figure 1-1: Manual Flowchart Based on Project Tier

## 1.2 Background

### 1.2.1 Storm Water Management & LID Concepts

The 1948 Federal Water Pollution Control Act was the first major U.S. law addressing water pollution, and initially focused on localized, easily identifiable sources (e.g., discharge of raw sewage or industrial waste) known as *point sources* of water pollution. In 1987, the Clean Water Act was amended by Congress to establish *nonpoint source* management programs, thereby shifting the focus to diffuse sources of water pollution without definite points of entry. Nonpoint sources have a variety of origins, mostly related to land use, such as the runoff from roads, roofs, parking lots, and pervious areas such as lawns, golf courses, and fields that enters the storm water conveyance system (i.e., storm drain inlets and piped connections) in different concentrations and at many locations. Subsurface transport (e.g., septic tank leachfields) and atmospheric deposition also contribute to nonpoint sources of pollution. The U.S. Environmental Protection Agency (U.S. EPA) has determined that pollution transported in precipitation and runoff from urban and agricultural lands is the primary cause of water quality impairment in the United States (U.S. EPA, 2000).

Federal, state, and local laws require the City of Santa Barbara to address local nonpoint sources of water pollution. Under natural conditions, nonpoint sources of water pollution are minimal. Land development creates an increase in impervious surfaces, which increases the amount of nonpoint sources of pollution entering storm water conveyance systems. As storm water runs off impervious surfaces (i.e., rooftops, roads, parking lots, etc.), it:

- Does not infiltrate, which significantly increases runoff volumes and flowrates;
- Moves more quickly, which significantly increases runoff velocities; and
- Entrain (i.e., picks up) pollution, which significantly increases sediment, nutrient, bacteria, and other toxic contaminant concentrations in receiving waters (i.e., local creeks and the ocean).

The impacts of these alterations due to development include:

- Increased concentrations of toxic pollutants and bacteria in surface receiving waters, including beaches near creeks and storm drain outlets.
- Increased flooding due to the increased runoff volumes.
- Decreased wet season groundwater recharge into streams (i.e., baseflows) due to decreased catchment infiltration and increased dry season groundwater recharge into streams due to outdoor irrigation with potable or reclaimed water.
- Similarly, introduction of baseflows in ephemeral streams due to surface discharge of dry weather urban runoff.
- Increased stream and channel bank erosion due to increased runoff volumes and higher stream velocities. Stream channels widen to accommodate and convey the increased volumes. The higher velocities also undercut and scour the banks, removing vegetation and aquatic habitat.

- Increased drinking water treatment requirements due to additional filtering and disinfection needed to cleanse the supply water from surface water sources such as reservoirs and rivers, which carry additional pollutants from land development.
- Increased stream temperature due to loss of riparian vegetation as well as runoff warmed by impervious surfaces, which decreases the dissolved oxygen levels in streams and makes the streams inhospitable to some aquatic life requiring cooler temperatures for survival.

The City of Santa Barbara has separate storm water and sanitary sewer conveyance systems. Everything that enters the storm water conveyance system is transported directly to receiving waters such as local creeks, streams, and the Ocean; it is not treated in a wastewater treatment plant. All untreated storm water runoff from impervious surfaces that drains into streets and enters storm drains directly contributes to nonpoint sources of water pollution. Sediment, pesticides, nutrients, metals, pathogens, hydrocarbons, and trash have been identified as storm water pollutants of concern for the City of Santa Barbara.

Land cover changes that accompany new development and redevelopment projects often increase an area's contribution to storm water runoff through a variety of mechanisms including altering drainage paths, compacting soils, and installing impervious surfaces such as buildings, roads, and parking lots. Reduction of runoff volumes and velocities (or discharge rate) by maintaining the natural hydrology of a site to the maximum extent practicable is an important step in decreasing the storm water pollutants of concern. Traditional treatment methods rely on centralized control and treatment systems that detain and treat, or detain and meter out the runoff volumes to reduce peak discharge rates for flood prevention. However, many of these systems lack the capability to decrease the volume and peak discharge rates enough to eliminate the erosive capabilities and downstream sedimentation that may occur due to the increased runoff volumes and discharge rates, though some may be modified to achieve hydrologic control.

A new strategy, low impact development (LID), is emerging to help deal with these issues. LID is based on designing a site to utilize its inherent natural hydrologic features to reduce the generation of runoff volume, discharge rate, and pollutants and to de-centralize the hydrologic control and treatment systems that handle the runoff that is generated. Combining site design techniques that mimic natural hydrology with smaller systems distributed throughout an area allows for maximum treatment, infiltration, storage, and evapotranspiration (uptake by plants) of runoff. LID also attempts to reduce the amount of impervious area, direct runoff from impervious areas to pervious areas, increase the infiltration and treatment capacity of pervious areas, and lengthen flowpaths between the source of the runoff and where it enters the hydrologic system, thereby increasing the time it takes the runoff to reach a main channel or drain. It is the goal of this Manual to provide guidance for integrating LID practices and principles into a site for preventing the generation of runoff and managing storm water runoff that does occur for all project types.

### ***1.2.2 Benefits of Storm Water Management***

The use of LID strategies aids in satisfying hydrologic and water quality regulatory requirements and, at the same time, offers environmental and cost benefits. LID begins at the preliminary site design phase by incorporating site design strategies that mimic natural hydrology, utilizing natural vegetation, and incorporating decentralized post-construction storm water BMPs to

prevent and reduce the hydrologic impacts of development to the maximum extent practicable (MEP). In December 2007, the U.S. EPA published "Reducing Storm water Costs through Low Impact Development (LID) Strategies and Practices." The report analyzed 17 case studies of developments that included LID practices, concluding that LID techniques can reduce project costs in addition to improving environmental performance. It was also found that the range in total capital cost savings was 15 to 80 percent, with a few exceptions where LID project costs exceeded conventional storm water management costs. It was noted that in all cases there were benefits that were not factored into the reported cost reductions. Integrating LID concepts early in the design process allows site designers more flexibility in their design because potential conflicts with other project goals can be identified during initial design rather than after work has begun, which will likely result in a better final product, both functionally and aesthetically. In addition, an LID design approach increases the likelihood that the resulting integration of BMP options will achieve the federally required MEP level of treatment (see Section 1.2.3 for more information on MEP).

### ***1.2.3 Federal and State Storm water Regulations***

In 1972, the Clean Water Act prohibited pollutant discharges from point sources into a navigable waterway of the United States unless it was in compliance with a National Pollutant Discharge Elimination System (NPDES) permit. As point sources were identified and pollution control measures were instituted, it became evident that storm water was an additional source of pollution. This led to the 1987 addition of section 402(p) to the Clean Water Act, which required the U.S. EPA to establish phased requirements for storm water discharges under the NPDES program. In 1990, Phase I of the NPDES Storm Water Program was enacted for storm water discharges from ten categories of industrial activity, municipalities serving a population of over 100,000 people with a separate storm sewer system, and construction activity that disturbed 5 acres or more of land. In 1999, Phase II of the NPDES Storm Water Program was promulgated by U.S. EPA, which expanded Phase I by requiring smaller municipalities and smaller construction sites to implement programs for controlling polluted storm water runoff. The Clean Water Act requires that states or the U.S. EPA establish standards for surface water quality, sewage treatment requirements, and wastewater discharge regulations. California assumed responsibility for implementing the Clean Water Act within the state of California.

In California, the Porter-Cologne Act of 1969 granted broad powers to the State Water Resources Control Board (State Board) as well as the Regional Water Quality Control Boards (Regional Water Boards) to govern water quality and water pollution issues to preserve and enhance all beneficial uses of California's water resources (California Environmental Protection Agency, 2006). The Regional Water Boards are also charged with developing water quality basin plans for the protection and enhancement of the State's water resources. In 2003, under Phase II of the NPDES Storm Water Program, the State Board adopted a NPDES Phase II General Permit No. CAS000004 (State General Permit) for the discharge of storm water from small Municipal Separate Storm Sewer Systems (MS4s) (WQ Order No. 2003-0005-DWQ). The City of Santa Barbara is designated as a small MS4 and is currently in the process of obtaining Phase II State General Permit approval. Phase II permittees are required to develop and implement a Storm Water Management Plan/Program (SWMP) with the goal of reducing the discharge of pollutants to the MEP (California Environmental Protection Agency: State Water Resources Control Board, 2006). The City has developed a SWMP, which is currently under review by the Central Coast Water Board. Approval of the City's SWMP by the Central Coast

Water Board is anticipated by October 2008. In addition, the City must also comply with additional requirements set by the Central Coast Water Board and the Santa Barbara County Flood Control and Water Conservation District.

According to the Central Coast Water Board, small MS4 permittees must incorporate LID methodologies into new development and redevelopment ordinances and design standards. They have identified the volume and velocity of storm water discharged from impervious surfaces as causing increased bank erosion and downstream sedimentation, scouring and channel widening, which significantly impact aquatic ecosystems and degrade water quality. Hydrologic and treatment systems that do not address the changes in volume and velocities (discharge rates) of storm water runoff and urban pollutants (including temperature) do not meet the required MEP standards set by the State General Permit. The State Board puts the onus on the permittee for demonstrating that conventional BMPs are equally effective or that they would result in a substantial cost savings while adequately protecting water quality and reducing discharge (runoff) volume and velocity (SWRCB Order No. WQ 2000-11).

#### ***1.2.4 Storm Water Management Plan/Program Requirements (Local Storm Water Regulations)***

The SWMP includes six minimum control measures that are outlined in the State General Permit. The fifth minimum control measure concerns post-construction storm water management for new development and redevelopment projects. Santa Barbara's SWMP defines post-construction storm water management BMPs as permanent facilities and on-going practices that address long-term storm water quantity and water quality from new development and redevelopment. The creation of this technical guidance document assists the City in implementing the post-construction storm water management minimum control measure of the State General Permit by providing guidance to new development and redevelopment projects for meeting the post-construction storm water BMP requirements as outlined in the City's SWMP. Santa Barbara also has multiple city plans (General Plan and Local Coastal Plan), municipal codes, and design review boards that include policies and permit processes for new development and redevelopment that address storm water management. Refer to the City of Santa Barbara SWMP for additional information.

Post-construction BMP requirements, as described in the SWMP, vary depending on project type. Projects are either required or encouraged to implement a combination of site design, basic BMPs, and storm water runoff BMPs as described in Chapters 4, 5, and 6 of this Manual. Incorporating one or more of these BMP types will reduce storm water runoff volume, discharge rate, and pollutant loads, as well as assist a project site's ability to mimic natural hydrologic conditions. The level at which a site integrates these BMPs will provide greater or lesser reductions in storm water runoff volume, velocity, and pollutant loads.

#### ***1.2.5 Local/Regional Coordination & Communication***

The City of Santa Barbara's storm water management review is integrated into the existing City process for reviewing development project applications. This review process involves coordination among multiple city departments. The SWMP includes a checklist that aids the different city departments and the project applicant in the coordination efforts needed to implement the SWMP requirements for post-construction storm water BMPs. This checklist is referred to as the City of Santa Barbara Development Application Review Team (DART) SWMP Checklist. The checklist facilitates each department's review by providing space for each of the

departments to review applicable sections of the application. There are ten sections under the post-construction storm water BMP portion of the checklist. These ten sections each represent a portion of the requirements for implementation of BMPs and are each assigned to applicable departments. For example, one requirement is the protection of slopes and channels, which requires approval by multiple departments (Planning, Building, Public Works, and Creeks), each based on their own criteria.

### 1.3 City of Santa Barbara Post-Construction Storm Water Management Requirements (as defined in the SWMP)

New development and redevelopment projects within the City of Santa Barbara are subject to various levels of permitting based on whether they require discretionary<sup>1</sup> or ministerial<sup>2</sup> permit approval. In general, discretionary permit approval is reserved for projects that include:

- annexations,
- specific plans,
- general plan land use designation amendments and zone changes,
- subdivision and lot line adjustments,
- conditional use permits,
- coastal development,
- development and site plans (e.g., commercial/industrial, mixed use, multi-family residential, parking lots, etc.), and
- land use conversions, variances, and modifications.

Discretionary projects vary in size and, while generally reserved for larger projects (greater than one acre as mandated by the State General Permit), the City of Santa Barbara has many discretionary projects that are smaller than one acre. All discretionary review projects in the City of Santa Barbara, regardless of size or land use type, receive extensive development review, may require preparation of an environmental document pursuant to the California Environmental Quality Act (CEQA), and receive detailed conditions of approval for storm water management, as applicable. Discretionary projects are also subject to subsequent design review and ministerial approval. Ministerial projects are projects that do not involve the types of permits identified under discretionary projects. Ministerial projects, which are mostly smaller projects (e.g., single-family residential projects), are not subject to the intensive discretionary review process but may be subject to design review and ministerial approval based on design guidelines, city plans, and ordinances. Similar to the review requirements, post-construction storm water requirements vary by project type.

---

<sup>1</sup> **Discretionary:** an action which requires the exercise of judgment or deliberation during the decision-making process, as distinguished from situations where the City is limited to a determination of conformity with applicable statutes, ordinances or regulations.

<sup>2</sup> **Ministerial:** a governmental decision involving little or no subjective judgment or discretion as to the wisdom or manner of carrying out the project; a ministerial decision involves only the use of fixed standards or objective measurements.



## 1.4 Project Tiers

Three project tiers, identified below, require different levels of post-construction storm water BMP implementation for both new development<sup>3</sup> and redevelopment<sup>4</sup> projects (see Table 1-1). Tier 1 (Small Projects) is the only category where post-construction storm water BMP implementation is completely voluntary. Tier 1 includes small (usually ministerial) projects that will be developing or redeveloping less than 500 square feet of impervious<sup>5</sup> area, and do not require Planning Commission (PC) review. Tier 2 (Medium Projects) include:

- All single-family residence projects involving between 500 and 4000 square feet of new or redeveloped impervious area, other than hillside residential projects, if no PC review is required;
- All multi family residence projects, 4 units or less, involving between 500 and 4000 square feet of new or redeveloped impervious area, if no PC review is required;
- All condo conversions involving 4 units or less;
- All commercial and residential reroofing projects involving between 500 and 4,000 square feet

Tier 2 projects are required to demonstrate the use of basic storm water BMPs as outlined in Chapter 5, but are not required to meet the more extensive storm water management requirements contained in Chapter 6. Tier 3 (Large Projects) include all discretionary projects that are not included in Tier 1 or 2, with the exception of minor discretionary projects identified in Appendix J. Tier 3 projects are required to implement a combination of site design, basic BMPs, and storm water runoff BMPs (Chapters 2 through 6) to meet the City's storm water runoff requirements (i.e., reductions in runoff volume, peak discharge, and pollutant loads) as outlined by the City's SWMP and as described in Section 6.2.

### 1.4.1 Requirements by Tier

- Tier 3 (Large projects) have the greatest number of SWMP requirements for project approval related to post-construction storm water management. Tier 3 projects must submit a design review application, including all associated documentation as required

---

<sup>3</sup> **New Development:** New development activity that includes construction, site alteration (e.g., paving, grading, excavating, filling, or clearing) or installation of structures, parking, storage facilities or other impervious surfaces.

<sup>4</sup> **Redevelopment:** Development activity that **replaces** existing structures, parking, storage facilities, or other impervious surfaces with an equivalent area of new impervious surfaces, and/or **expands** existing structures, parking or storage facilities by adding new impervious surfaces. Interior remodeling projects and tenant improvements are not considered to be redevelopment.

<sup>5</sup> **Impervious Surface / Area:** A hard surface area that either prevents or significantly retards the entry of water into the soil mantle compared to the predevelopment condition. A hard surface area that causes water to run off the surface in greater quantities or at an increased rate of flow from the predevelopment flow. Common impervious surfaces include, but are not limited to, rooftops, walkways, patios, driveways, parking lots or storage areas, concrete or asphalt paving, packed earthen materials, and oiled, macadam or other surfaces, which similarly impede the natural infiltration of storm water. Open, uncovered retention/detention facilities shall not be considered as impervious surfaces.

by the application and checklist, and applicants must review the DART SWMP Checklist (Appendix L) with City staff. As shown in Table 1-1, Tier 3 is required to use and implement practices and methodologies from Chapters 2 - 6 in this Manual (or some other BMP design(s) that is appropriate for the site and attains the storm water runoff requirements outlined in the SWMP (also included in Section 6.2 of this Manual). The chapters are arranged in the order in which they should be used. This means that site and soil assessments should be conducted before the selection of BMPs is possible. How many BMPs are implemented into a project depends on the site and soil assessments (Chapters 2 and 3), and what site design BMPs (Chapter 4), basic BMPs (Chapter 5), and storm water runoff BMPs (Chapter 6) are appropriate for the project site to attain the storm water runoff requirements. For some projects, implementing one BMP will meet the requirements and thereby be sufficient. For others, multiple BMPs may be more appropriate and protective of water quality. For information on the benefits of combining multiple storm water BMPs see Section 4.8.

- Tier 2 projects require the submission of a simple site plan. As shown in Table 1-1, Tier 2 projects are required to use and implement one or more practices and methodologies from Chapter 5. The basic BMPs in Chapter 5 are only required for Tier 2 if the project applicant has to obtain a permit from the City. The more elaborate BMPs described in Chapters 4 and 6 are voluntary, but encouraged.
- Tier 1 projects are encouraged to implement appropriate storm water BMPs, such as the site design recommendations from Chapter 5, but no action is required.

**Table 1-1: Post-Construction Project Tiers**

| Tiers   | Project Type  | Requirement  | Applicable Report Chapters                   |  |                                    |                              |   |
|---|---|--|--|--|------------------------------------|------------------------------|---|
|   |   |  | Chapter 2: Site Assessment and BMP Selection | Chapter 3: Site Soil and Infiltration Assessment | Chapter 4: Site Design BMP Options | Chapter 5: Basic BMP Options | Chapter 6: Storm Water Runoff BMP Options |
| <b>Tier 1<br/>(Voluntary)</b>                       | SMALL PROJECTS <sup>1</sup><br>(Projects with < 500 sq. ft. of new or replaced impervious area)   | Voluntary use of site design, basic, and/or storm water runoff BMP options   | ▼  | ▼  | ▼                                  | ▼                            | ▼   |
| <b>Tier 2<br/>(Basic Requirements)</b>              | MEDIUM PROJECTS <sup>1</sup><br>(Projects with 500 to 4000 sq.ft. of new or replaced impervious area)   | Select and implement Basic BMP option(s) and identify on the Site Plan   | ▼  | ▼  | ▼                                  | ✓                            | ▼   |
| <b>Tier 3<br/>(Storm Water Runoff Requirements)</b> | LARGE PROJECTS <sup>1</sup><br>(Commercial, Residential > 4000 sq. ft. of new or replaced impervious area, Mixed Use, Parking Lots 10 or more spaces, Hillside Residential, and Public Works Projects) <sup>2</sup> | Meet the <i>Storm Water Runoff Requirements</i> <sup>3</sup> through site design, basic BMPs, and storm water runoff BMP options | ✓  | ✓  | ✓                                  | ✓                            | ✓   |

<sup>1</sup> Small, Medium, Large projects more specifically defined in Section 1.4

<sup>2</sup> Exemptions outlined in Appendix J.

<sup>3</sup> The *Storm Water Runoff Requirements* as defined in the City's SWMP (and Chapter 6 of this Manual).

|                 |                  |
|-----------------|------------------|
| <b>Required</b> | <b>Voluntary</b> |
| ✓               | ▼                |

## 1.5 How to Use This Manual

The purpose of this section is to assist the user in navigating the Manual to find information pertinent to the tier of the proposed project (See Figure 1.1).

The following provides a summary of the contents of Chapters 2-6 and the appendices.

**Chapter 2: Site Assessment and BMP Selection**, discusses the process for assessing a site's conditions and constraints, and selecting appropriate BMPs based on the project's tier requirements, pollutants of concern, and site conditions.

**Chapter 3: Soil Assessment Methods**, discusses: (1) the level of soil assessment needed for Tier 3 projects, (2) who should conduct the assessment, (3) the goals of a preliminary site investigation, and (4) the steps involved in test pit investigations and infiltration/permeability tests.

**Chapter 4: Site Design BMP Options**, introduces the objectives and process of site design, identifies specific site design options, and presents issues to consider when implementing site design principles. This chapter also provides some examples of how site design practices can be implemented for different project types (e.g., single-family residential vs. commercial). Chapter 4 is required for Tier 3 projects and is voluntary for Tier 1 and Tier 2 projects.

**Chapter 5: Basic BMP Options**, provides guidance for selecting and implementing appropriate basic BMPs for mitigating runoff from new and redeveloped impervious surfaces. Basic BMPs are required for Tier 2 projects. Basic BMPs alone cannot be used to meet the storm water runoff requirements for Tier 3 projects, although they do assist in reducing storm water runoff volumes, discharge rates, and pollutant loadings. Chapter 5 contains practical, user-friendly BMP factsheets for each of the basic BMP options. See Table 5-1 for a basic BMP comparison matrix that assists users in identifying basic BMPs appropriate for a project's specific site conditions and tier.

**Chapter 6: Storm Water Runoff BMP Options**, provides guidance to new development and redevelopment Tier 3 projects for selecting, sizing, designing, implementing, and maintaining storm water runoff BMPs that meet the storm water runoff requirements set forth by the City's SWMP (and outlined in Section 6.2). Chapter 6 contains BMP factsheets and engineering design details for a series of storm water runoff BMP options grouped into BMP type categories. Chapter 6, along with Appendix D, provides example sizing and design calculations for the different BMP options. See Table 6-2 for a storm water runoff BMP selection matrix that assists users in identifying storm water runoff BMPs appropriate for a project's specific site conditions and meeting the project's specific storm water runoff requirements.

**Appendix A: Glossary of Terms** - defines terms used in this Manual.

**Appendix B: Site Conditions Maps** - includes maps of the Santa Barbara area with soil types, slopes, special hillside/coastal bluff districts, and floodplain areas.

**Appendix C: BMP Sizing Methodologies** - explains the BMP sizing methodologies for meeting the storm water runoff requirements as outlined in Section 6.2.

**Appendix D: BMP Design Examples** - includes example calculations for sizing and designing Tier 3 storm water runoff BMPs.

**Appendix E:** Pond Outlet Sizing Examples – provides example sizing and design calculations for different pond outlet design types.

**Appendix F:** Flow Splitter Design Specifications – provides specifications for sizing and designing flow splitters for off-line BMPs.

**Appendix G:** Plant List - provides a (mostly) native plant list for vegetated BMPs described in Chapter 5 and 6.

**Appendix H:** Facility Inspection Checklists - provides inspection checklists for the storm water runoff BMPs provided in Chapter 6.

**Appendix I:** Maintenance Agreements - presents sample maintenance agreements for ensuring long-term maintenance of private Tier 3 storm water runoff BMPs.

**Appendix J:** List of Discretionary Projects Exempt from Tier 3 Requirements – provides a list of exempt minor discretionary project types.

**Appendix K:** DART SWMP Checklist – A copy of the Santa Barbara Development Application Review Team (DART) SWMP Checklist.

## 2 SITE ASSESSMENT AND BMP SELECTION

### 2.1 Assessing Site Conditions and Other Constraints

An integral step in designing a site that incorporates an appropriate combination of post-construction storm water BMPs (including site design, basic BMPs, and storm water runoff BMPs as discussed in Chapters 4 through 6) as required by project tiers, is assessing the existing site conditions. Whether a site is being developed for the first time or is being redeveloped, there are multiple opportunities in the development process to incorporate post-construction storm water BMPs to enhance the hydrologic and ecological functionality of a site and meet project tier requirements (See Section 1.3).

**The maps in Appendix B should be used to identify possible site constraints early in the process** before (not in lieu of) the required soil assessment (Chapter 3), to get a general idea of local conditions. The maps in Appendix B provide general information on the distributions of hydrologic soil types and percent slope ranges, as well as the approximate locations of the Hillside Design and Coastal Bluff Districts. The information in these tables and figures provides general guidance on site characteristic trends within the City; however, verification of characteristics that are integral to a BMP must be conducted independently to account for site specific characteristics.

In order to select appropriate BMPs and possible locations for them, the designer must accurately assess the specific existing site conditions. A comprehensive site assessment that identifies critical site characteristics is integral to the successful design and implementation of all types of post-construction storm water BMPs. While the information gathered during the site assessment may not need to be submitted to the City (depending on tier and type of information gathered), it will assist in determining which types of BMPs may be implemented, combined, and located throughout the site. For Tier 3 projects, one or more qualified professionals (e.g., civil engineer, landscape architect, certified storm water professional, and/or geotechnical engineer) should conduct the site assessment evaluating existing conditions, including the site’s hydrology, topography, soils, and vegetation. Types of information that are required for the site designer, though not all are required to be provided to the City, and are typically included in the site assessment are shown in Table 2-1 below.

**Table 2-1: Typical Site Assessment Information**

| Assessment Category            | Type of Information  |
|--------------------------------|--|
| Existing Hydrology/Hydrography | <ul style="list-style-type: none"> <li>• Site drainage patterns</li> <li>• Flood hazards</li> <li>• Depth to groundwater</li> <li>• Connections to the storm drain system</li> <li>• Nearby waterways (including receiving water quality and hydraulic conditions)</li> <li>• Locations of any seeps or springs</li> </ul> |
| Existing Topography            | <ul style="list-style-type: none"> <li>• Surface drainage paths</li> <li>• Locations of local high and low points</li> <li>• Significant geologic features</li> <li>• Steep slopes and/or cliffs</li> </ul>  |

| Assessment Category      | Type of Information   |
|--------------------------|---|
| Existing Soils           | <ul style="list-style-type: none"> <li>• Identification of soil types (hydrologic soil group)</li> <li>• Permeability</li> <li>• Site susceptibility to erosion, landslides, and other geotechnical hazards</li> <li>• Depths of subsoil</li> </ul> |
| Existing Vegetation      | <ul style="list-style-type: none"> <li>• Types and relative amounts</li> <li>• Estimate of site evapotranspiration rate</li> <li>• Identify weed species</li> <li>• Identify sensitive species</li> </ul>   |
| Climate conditions       | <ul style="list-style-type: none"> <li>• Average precipitation</li> <li>• Seasonal variation in precipitation</li> <li>• Temperature range</li> </ul>   |
| Local Regulatory         | <ul style="list-style-type: none"> <li>• Municipal zoning ordinances</li> <li>• Design standards</li> <li>• Design guidelines</li> </ul>  |
| Local Services/Utilities | <ul style="list-style-type: none"> <li>• Proximity of utilities to site (including locations if on-site)</li> <li>• Requirements of local services (e.g., fire safety)</li> </ul>   |

In addition to assessing existing site conditions, it is imperative (to the designer) to determine other constraints that will dictate design and implementation of post-construction storm water BMPs. Other important factors that may constrain design and implementation are the initial capital costs, the reliability of selected BMPs, the need to meet specific reduction goals for specific pollutants of concern (see Section 2.2 and Tables 2-2 and 2-3), the need to meet the storm water runoff requirements for Tier 3 projects (Section 6.2), and on-going long-term maintenance that may be required. BMPs shall be selected based on the probability of long-term success including site specific factors that may contribute to or reduce the chance of failure of a given BMP to function properly (hydraulically and performance wise).

## 2.2 Assessing Pollutants of Concern

An important step in minimizing runoff pollution is identifying the pollutants of concern. The City of Santa Barbara has been conducting water quality monitoring programs since 1998. From these studies, the City has identified local pollutants of concern, both known and suspected, that must be considered when selecting BMPs. The City of Santa Barbara's SWMP lists seven pollutant groups as either known or suspected pollutants of concern. These pollutants can typically be related to land use, which means that the developed condition of the site provides some indication of the pollutants that will be generated, post-construction. Table 2-2 identifies pollutants of concern based on post-construction project land use. Table 2-2 provides general guidance; however, based on specific site characteristics or type of activity, pollutants of concern may be different from shown. Additional pollutants of concern may be identified based on specific site characteristics, such as known soil contaminants in redevelopment sites or specific proposed site activities. BMPs shall be selected to address, at minimum, the pollutants of concern listed in Table 2-2 for the proposed land use(s) as well as those listed in Table 2-3 for 303(d) listed water bodies (i.e., surface waters listed by the State as "impaired" for certain pollutants of concern) that receive runoff from the project site.

**Table 2-2: Pollutants of Concern Based on Land Use**

| Land Use   | Pollutant Category of Concern |           |          |        |          |              |                           |
|--|-------------------------------|-----------|----------|--------|----------|--------------|---------------------------|
|  | Trash                         | Nutrients | Bacteria | Metals | Sediment | Other        |                           |
|  |                               |           |          |        |          | Hydrocarbons | Pesticides and Herbicides |
| Commercial, Institutional, and Mixed-Use Developments        | ✓                             | ✓         | ✓        |        | ✓        | ✓            | ✓                         |
| Industrial   | ✓                             | ✓         | ✓        | ✓      | ✓        | ✓            | ✓                         |
| Roads and Parking Lots                                       | ✓                             | ✓         |          | ✓      | ✓        | ✓            | ✓                         |
| Restaurants  | ✓                             | ✓         | ✓        |        |          | ✓            |                           |
| Automotive   | ✓                             |           |          | ✓      |          | ✓            |                           |
| Multi- and Single-Family Residences (Including Subdivisions) | ✓                             | ✓         | ✓        |        | ✓        | ✓            | ✓                         |
| Hillside Developments  | ✓                             | ✓         |          |        | ✓        | ✓            | ✓                         |

All of the pollutants of concern categories are described below, including common sources and common problems they cause.

***Trash***

The trash category includes debris and floatables. Trash enters storm water through streets and storm drain inlets, areas with high pedestrian traffic, and poor landscape maintenance practices. Not only are gross pollutants unsightly, but they may also interfere with oxygen exchange, carry bacteria, and cause vector problems.

***Nutrients (Nitrogen and Phosphorus)***

Potential sources of nutrients in storm water include fertilizer use (public and private), discharge of wash water that contains soaps and detergents (variety of sources including restaurants, commercial properties, and residential car washing). High nutrient concentrations may cause accelerated or excessive growth of algae and eutrophication in lakes and other water sources. In addition, a form of nitrogen may be toxic to fish.



***Bacteria***

Indicator bacteria (e.g., total/fecal coliform, E. coli, and enterococcus) are used to infer the presence of pathogenic organisms that are fecal in origin. Indicators are necessary due to difficulties in measuring pathogen concentrations directly. Potential sources of indicator bacteria include human excrement (from either direct deposit or leaking sewage or septic systems), animal excrement (both domestic and wild), and outdoor restaurant washing. High concentrations of indicator bacteria (i.e., those that exceed recreational contact standards) trigger the closure of beaches, lakes, and rivers.

***Metals***

In general, metals that can be found in storm water include cadmium, chromium, copper, lead, nickel, and zinc. Metals that have been identified as pollutants of concern by the City in storm water include magnesium, zinc, potassium, and iron. Potential sources include naturally occurring metals, automobiles, illegal or improper disposal of lead batteries, and many common materials (e.g., galvanized metal, paint, preserved wood, etc.). Metals can be toxic to aquatic organisms and contaminate drinking water supplies. Bioaccumulation is also a problem for some metals because as they accumulate in the tissues of organisms lower in the food chain they may potentially result in elevated levels in larger organisms that feed on them, which are food sources for humans.

***Sediment***

The City has identified natural erosion, dirt roads, creek side development, construction, land development, and agriculture as potential sources of sediment. While construction runoff is managed under a different program, land development and agriculture are the main sources that should target sediment when selecting BMPs. High sediment concentrations not only make the water appear murky, but also tend to carry adsorbed pollutants with them. In addition, downstream sedimentation may threaten fish and other aquatic life by interfering with respiration, growth, reproduction, photosynthesis, and oxygen exchange.

***Hydrocarbons***

Oil and grease enter storm water through a variety of mechanisms and sources, including automotive sources, leakages/spills, parking lots, restaurants, and illegal or improper disposal. Some of the hydrocarbons that are found in oil and grease are toxic to aquatic organisms and produce unsightly sheens, even at low concentrations. Some also present bioaccumulation risks.

***Pesticides***

Landscaped areas are potential sources of pesticides entering storm water. Pesticides include insecticides, herbicides, fungicides, and rodenticides. Some pesticides are toxic to aquatic organisms, even at low concentrations, and can bioaccumulate. Several chemical formulations are banned but even some allowed pesticides still present toxicity risk to aquatic organisms.

**Table 2-3: 303(d) Listed (2006) Water Bodies and Associated Pollutants**

| 303(d) Listed Water Body                              | Pollutant Category of Concern |        |                             |                   |                               |
|---|-------------------------------|--------|-----------------------------|-------------------|-------------------------------|
|   | Bacteria                      | Metals | Sedimentation and Siltation | Priority Organics | Unknown <sup>1</sup> Toxicity |
| Arroyo Burro Creek                                    | ✓                             |        |                             |                   |                               |
| Goleta Slough   | ✓                             | ✓      | ✓                           | ✓                 |                               |
| Mission Creek   | ✓                             |        |                             |                   | ✓                             |
| Pacific Ocean at Arroyo Burro Beach                   | ✓                             |        |                             |                   |                               |
| Pacific Ocean at East Beach (mouth of Mission Creek)  | ✓                             |        |                             |                   |                               |
| Pacific Ocean at East Beach (mouth of Sycamore Creek) | ✓                             |        |                             |                   |                               |
| Pacific Ocean at Hope Ranch                           | ✓                             |        |                             |                   |                               |
| Pacific Ocean at Leadbetter Beach                     | ✓                             |        |                             |                   |                               |

<sup>1</sup> Toxicity should be equated to metals and priority organics from Table 2-2.

The pollutants in the City's water bodies that are listed on the 2006 303(d) list as shown in Table 2-3, above, have been attributed to urban runoff, non-point sources, industrial point sources, and construction and land development.

### 2.3 BMP Selection Process

Important factors that may constrain BMP selection are the initial capital costs, the reliability of selected BMPs, the need to meet specific reduction goals for specific pollutants of concern (see Section 2.2), the need to meet the storm water runoff requirements for Tier 3 projects (Section 6.2), and on-going long-term maintenance that may be required. BMPs shall be selected based on the probability of long-term success including site specific factors that may contribute to or reduce the chance of failure of a given BMP to function properly (hydraulically and performance wise).

BMPs shall be selected based on the following items to the maximum extent practicable:

1. site specific constraints;
2. pollutants of concern based on proposed land use type and receiving water conditions;

3. low impact development principles and practices (see Section 1.2.1);
4. meeting the post-construction storm water requirements based on project tier (see Section 1.3);
5. cost considerations; and
6. long-term maintenance considerations.

Targeting specific pollutants of concern based on proposed land use and known site contaminants is required. Site and soil assessment information (Chapters 2 and 3) shall be used in combination with the BMP matrix tables: Table 5-1, Table 6-1, Table 6-2 (Chapters 5 and 6, respectively), to determine appropriate BMPs for a given site.

### 3 SITE SOIL AND INFILTRATION ASSESSMENT

The purpose of the site soil assessment and infiltration testing is to determine where BMPs should be located on the site and if infiltration BMPs are feasible on the site. This chapter is intended for Tier 3 projects. Refer to Section 5-2 in Chapter 5 for soil assessment methodologies for Tier 1 and Tier 2 projects.

Site soil assessment and infiltration testing should be conducted early in the design process to facilitate LID site design principles and practices. When sites are designed without initially assessing the site's soil characteristics or considering LID site design principles and practices in the initial design process, often times the chance to preserve the site's natural hydrology, distribute post-construction storm water BMPs appropriately across a site, and preserve the site's soil infiltration capacity in areas where at appropriate BMP locations is limited. However, if the site soil assessment and infiltration testing occurs early in the design process, potential infiltration sites may be identified and measures can be taken to preserve the infiltration capability of the site and reduce implementation costs.

#### 3.1 Who Should Conduct the Assessment?

A qualified soil scientist or geotechnical professional should conduct the test pit investigation and infiltration tests. The professional should be experienced with not only the testing procedures themselves but also the requirements of the potential BMPs to ensure that additional information regarding the siting of BMPs is acquired during the test pit investigations.

#### 3.2 Preliminary Site Investigation

A preliminary site investigation will likely reduce the number of test pit investigations needed by identifying strategically placed test sites. Prior to developing a detailed site plan or performing soil testing, the site should be evaluated based on existing information. Existing information includes, but is not limited to, soil maps, hydrologic soil group classifications, geology, streams, topography, slope, drainage patterns, existing and previous land uses, and features that may impact design. The proposed development should be considered when evaluating the background information to ensure pertinent information is gathered, specifically related to the development plan. In addition, the development plan in combination with the preliminary site evaluation allows for identification of key locations of concern as well as potential BMP locations, particularly focusing on identifying BMP locations that are most amenable to infiltration.

#### 3.3 Test Pit Investigation

A test pit investigation is an integral part of the site soil assessment since it provides subsurface site specific data that aids in the design of the site and identifies appropriate locations and types of BMPs appropriate for the site. Soil maps and hydrologic soil groups are based on regional data and provide a general understanding of what to expect; however, there are undoubtedly unknowns that will be discovered during these initial observational tests. A test pit investigation involves digging or excavating a test pit (deep hole). By excavating a test pit, overall soil conditions (both vertically and horizontally) can be observed in addition to the soil horizons. To maximize the knowledge gained during the test pit investigation, many tests (to be determined by a licensed civil engineer) and observations should be conducted during this process.

Test pits should be excavated to a depth at least three feet deeper than the proposed bottom of the BMP for non-infiltration BMPs and at least eleven feet deeper than the proposed bottom of the BMP for infiltration BMPs. See the BMP site suitability selection matrix (Table 6-2) for identifying the minimum depth to seasonal high groundwater for the different storm water runoff BMP options for Tier 3 projects.

A project that imports fill must characterize the proposed soil profile at the specified depths. For example, if the proposed depth of fill is 5 feet and an infiltration BMP is to be used in the location of the fill, both the fill and the native subsoil require soil characterization. Figure 3-1 illustrates the proposed soil profile that would result with 5 feet of fill. Note that the infiltration BMP will occupy the first 2 feet of the fill. Since the test pit must be excavated to a depth that is 11 feet deeper than the bottom of the proposed infiltration BMP, a test pit investigation of the top 8 feet of native subsoil is required, in addition to the laboratory sample of the fill material. Characterization of the fill material should be conducted in a laboratory. See Section 3-6 for additional information. It is recommended that soil compaction is limited in the location of a proposed infiltration BMP.

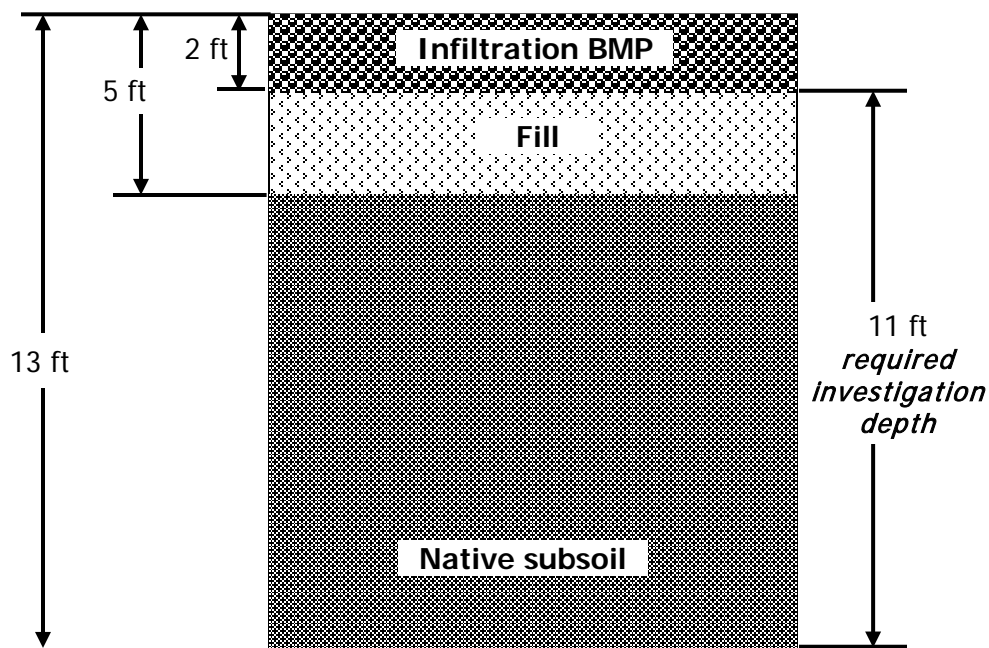

**Figure 3-1: Post-fill Soil Profile**  
Diagram Credit: Geosyntec Consultants

As the test pit is excavated, the following measurements should be made:

- Standard penetration testing to determine the relative density as it changes with depth (minimum intervals of 2-3 feet), and
- Infiltration testing with one test occurring at the proposed bottom of the BMP.

In addition, many observations should be made during and after the excavation of the soil pit, including:

- Elevation of groundwater table or indication of seasonally high groundwater table
- Soil horizon observations, including:
  - Depths indicating upper and lower boundaries of the soil horizons
  - Depths to limiting layers (i.e., bedrock and clay)
  - Soil textures
  - Colors and their patterns
  - Estimates of the type and percent of coarse fragments
- Locations and descriptions of macropores (i.e., pores and roots)
- Other pertinent information/observations

The number of test pits required depends largely on the specific site and the proposed development plan. Additional tests should be conducted if local conditions indicate significant variability in soil types, geology, water table levels, bedrock, topography, etc. Similarly, uniform site conditions may indicate that fewer test pits are required. Excessive testing and disturbance of the soil prior to construction is not recommended. When test pit investigations are complete, including infiltration testing, the pits should be refilled with the original soil and the surface replaced with the original topsoil.

### 3.4 Infiltration Tests

There are a variety of infiltration field test methodologies available to determine the infiltration capacity of a soil. Infiltration tests should be conducted in the field in order to ensure that the measurements are representative of actual site conditions (including inherent heterogeneity). While it is recommended that these tests occur during the wet season, it is not necessary. When tests are conducted during other seasons, indications of seasonally high groundwater table should be noted using the NRCS hydric soil field indicators guide (NRCS, 2003). None of these tests should be conducted in the rain, or when temperatures are at or below freezing. For a site to be considered amenable to an infiltration BMP, the infiltration rate measured must be between 0.5 and 2.4 in/hr. If the measured infiltration rate is not within this range, it increases the risks of not enough infiltration (e.g., localized flooding) or of too much infiltration (e.g., may indicate macropore flow or other preferential pathway that would not provide adequate treatment). A factor of safety may be added to the measured infiltration rates to account for compaction and clogging over time. If using a BMP that requires infiltration, refer to the information on the specific BMP (Chapter 6) for requirements regarding incorporating a factor of safety.

To ensure groundwater is protected and that the infiltration BMP is not rendered ineffective by overload, it is important to periodically verify infiltration rates of the constructed BMP(s).

### 3.5 Falling-Head Infiltration Testing Procedure

There are a number of in-situ infiltration test methodologies; however, the method presented here is the falling-head infiltration test, a simple test to perform in the field. Since there are multiple falling head infiltration methods, the expert conducting the test should determine which type of infiltrometer to use for characterizing the infiltration rate based on knowledge of

the methods and the soil types. Usually infiltration rates should be determined at a minimum of two locations in each test pit and one must be conducted at the proposed bottom depth of the BMP. The actual number of tests required depends on the soil conditions; if the soils are highly variable, more tests may be required.

1. Remove any smeared soil surfaces to provide a natural soil interface for testing the percolation of water. Remove all loose material. The U.S. EPA recommends scratching the sides with a sharp pointed instrument. (*Note:* upon tester's discretion, a 2-inch layer of coarse sand or fine gravel may be placed to protect the bottom from scouring and sediment.) Fill casing with clean water and allow to pre-soak for 24 hours or until the water has completely infiltrated.
2. Refill casing and monitor water level (distance from top of casing to top of water) for 1 hour. Repeat this procedure a total of four times. (*Note:* upon tester's discretion, the final field rate may either be the average of the four observations or the value of the last observation. The final rate shall be reported in inches per hour.)
3. Testing may be done through a boring or open excavation.
4. The location of the test must be near the proposed facility.
5. Upon completion of the testing, the casings shall be immediately pulled and the test pit shall be back-filled.

### **3.6 Laboratory Soil Tests**

If fill will be used in identified locations of BMPs, a laboratory test is required to determine the hydraulic conductivity of the soil. A sample of the soil from each area where a BMP will be located must be tested. The soil sample must be compacted to the same degree that will be present after final grading. Once prepared the sample should be sent to a specialty laboratory to conduct a test of the conductivity. These results may then be used to assess the applicability of a specific BMP.

## 4 SITE DESIGN BMP OPTIONS

### 4.1 Introduction

This chapter provides general site design BMP options that can be implemented as part of all project types, although **only Tier 3 projects** are required to consider the BMPs in this chapter. Project applicants and designers should review this chapter before choosing the specific BMP(s) for their site, identified in Chapters 5 and 6. This chapter provides an understanding of the overall “big picture” site design requirements that support and ensure the success of the specific BMP designs in Chapters 5 and 6.

The basic BMPs in Chapter 5 incorporate specific site design and storm water runoff BMPs that are directly applicable to smaller residential projects. Some of the basic BMPs in Chapter 5 can also be used in Tier 3 projects. Chapter 6 provides design guidance for storm water runoff BMPs applicable to Tier 3 projects. It is the City's goal for LID practices, such as these site design BMPs, to be implemented into projects of every tier.

#### 4.1.1 Goals and Objectives

Site design BMPs are designed to minimize the hydrologic impacts created by site development and are based on the principles and practices of LID, see Section 1.2.1. LID practices attempt to preserve a site's essential natural hydrologic functions and mimic pre-development hydrology by using techniques that treat, store, infiltrate, and evaporate runoff close to its source. Site design BMPs achieve LID goals by:

- Conserving and restoring natural areas as much as possible;
- Maintaining, restoring, and using natural flowpaths for runoff; thereby increasing the amount of time it takes runoff to reach a street, main channel, or drain;
- Reducing the impacts of development by minimizing soil disturbance and compaction;
- Reducing the amount of impervious area and directing runoff from impervious areas to pervious areas to promote local infiltration and evapotranspiration;
- Integrating landscape and storm water management objectives; and
- Siting storm water runoff BMPs on infiltrative soils.

Site design BMPs, when used in conjunction with small-scale basic and storm water runoff BMPs distributed throughout a site, allow for significant minimization of hydrologic impacts (see Chapters 5 and 6 for more information on basic and storm water runoff BMP options). By addressing issues locally and tailoring the site design, basic BMPs, and storm water runoff BMPs to be site specific, the result is a functional landscape that maintains the critical natural hydrologic and ecological functions of the developed site and the local watershed to the maximum extent practicable. A variety of site design, basic BMPs, and storm water runoff BMPs are available, providing options for designers to achieve site specific customization based on (1) site specific constraints (e.g., soils, topography), (2) pollutants of concern based on land use type, (3) low impact development principles and practices, (4) meeting the post-construction



storm water requirements based on the project tier (see Section 1.3), (5) cost considerations, and (6) long-term maintenance considerations. Site design should also consider the receiving water beneficial uses and water quality objectives found in the Water Quality Control Plan for the Central Coast Basin (Basin Plan) and other local plans to ensure that all watershed planning objectives are met. In addition, the Central Coast Water Board has outlined requirements, including the use of LID practices for SWMPs, to achieve the following conditions:

- Maximizing the infiltration of clean storm water,
- Minimizing runoff volume and rate (i.e., velocity),
- Protecting riparian areas, wetlands, and their buffer zones,
- Minimizing pollutant loadings, and
- Providing long-term watershed protection.

#### **4.2 Conserve and Restore Natural Areas**

The first step in integrating existing hydrology into the design of a site is to identify sensitive areas that affect the essential hydrology of the site. These sensitive areas include streams and their buffers, floodplains, wetlands, steep slopes, high permeability soils, and woodland conservation zones. In addition, areas that may be restored or revegetated either during construction or later, should also be identified. Once the natural areas of importance are identified, they should be cordoned off with necessary buffer area to protect them during the development activities, which leaves the remaining area for development, thereby defining the “development envelope” in which development may occur. By conserving vital natural areas at the beginning of the process, it is easier to minimize the hydrologic impacts of development by developing the areas that will have the least impact. This strategy not only minimizes the amount of runoff that will need to be captured and/or treated, thereby reducing costs, but also provides for aesthetically pleasing post-development landscaping. The City of Santa Barbara is noted for extensive incorporation of trees and landscaping within the urban landscape and their General Plan policies and ordinances support site design criteria to conserve natural areas (City of Santa Barbara, 2007). Buffer zones (a minimum of 25 feet) should be used to preserve and protect sensitive areas such as riparian areas and stream corridors. Additional trees and vegetation should be planted where possible.

### 4.3 Maintain, Restore and Utilize Natural Flow Paths

Conventional development decreases the time of concentration,  $T_c$ , which is the time it takes for runoff to travel from the farthest point in a drainage area (also known as tributary area) to the drainage area outlet. The decrease in the  $T_c$  is caused by increasing impervious surfaces and installing drainage pipes, which transport water off-site more efficiently than natural flow paths. The smaller  $T_c$  present at conventionally-developed sites leads to greater runoff velocities and higher peak flow rates, which result in increased transport rates of sediment and other pollutants, increased erosion, and decreased groundwater recharge. Unlike conventional development that incorporates storm drains into designing a site, LID promotes the incorporation of natural flow paths.

By designing a site layout to preserve the natural hydrology and drainage ways on the site, it reduces the need for grading and disturbance of vegetation and soils (GSMM, 2001). By siting buildings and impervious surfaces away from steep slopes, drainageways, and floodplains also limits the amount of grading, clearing, and disturbance as well as reduces the hydrologic impact.

The utilization of pervious vegetated flow paths instead of concrete-lined conveyances such as storm water conveyance systems (i.e., storm drain inlets and pipe) reduces the cost of constructing these conveyances and reduces the need for land disturbance and grading. In addition, due to the benefits of natural systems,  $T_c$  increases, peak discharges decrease, on-site storage increases, some of the runoff infiltrates, and the concentration of pollutants in runoff decreases. Natural flowpaths may be enhanced by installing a vegetated swale filter in place of a curb and gutter system on a street right-of-way. When used in street rights-of-way, swales not only provide a flow path but also provide room for storage, reduced velocities, increased infiltration, and treatment of storm water. In the past, roadside ditches have suffered from erosion, standing water, and road disintegration; however, designs have been improved and those problems minimized when properly designed swales are implemented under the appropriate site conditions.

Existing natural drainage divides and depressions should be maintained to direct and store water on-site to the maximum extent practicable. By maximizing sheet flow, or shallow evenly dispersed flow over vegetated areas, the water is filtered, allowed to infiltrate, and its velocity decreased. Sheet flow may occur naturally or by using a flow spreader such as a level spreader or disperser. In addition, check dams could be incorporated into open flow paths to slow the runoff velocity. Decreasing slopes (to a certain extent and within site constraints) slows velocities, which decreases the potential of erosion. Roughened surfaces (e.g., creating tracks perpendicular to the direction of flow or by planting denser or taller vegetation) increase flow path lengths and therefore,  $T_c$ . Avoiding or minimizing the use of hard conveyances such as curbs, gutters, and pipes decreases the efficiency at which runoff is transported, which increases the  $T_c$ . In heavily developed areas, it is still possible to incorporate the use of natural flow paths to decrease runoff velocities and peak flow rates during retrofit/redevelopment activities. Buffer areas may be used to allow runoff to dissipate and reduce  $T_c$ . In addition, disconnecting impervious areas (as discussed in Section 4.7) may be used to increase the  $T_c$ .

#### 4.4 Site BMPs on Infiltrative Soils

LID is guided by the preservation of a site's existing hydrology, including the site's infiltration capacity. Conventional development decreases a site's ability to infiltrate runoff by increasing the amount of impervious area, connecting impervious surfaces together, and directing runoff from impervious surfaces to the storm water conveyance system for efficient conveyance of storm water off-site. The effects of development on the infiltration of runoff can be mitigated by reducing the amount of impervious area, disconnecting impervious areas from each other and the storm water conveyance system, and, where feasible, siting infiltration storm water BMPs on infiltrative soils (or conversely siting the impervious area on the least infiltrative site soil).

Infiltrative soils may be preserved by minimizing and carefully planning clearing and grading activities to minimize compaction of infiltrative soils (see Section 4.5), reserving areas with A and B Hydrologic Soil Group soils for either open space or infiltration BMPs (see Section 4.2 and 4.4), and by directly reducing the amount of impervious area (see Section 4.6). Once the impervious area is minimized, the effects of the remaining imperviousness may be reduced by installing infiltration BMPs to maximize infiltration of runoff on-site.

#### 4.5 Minimize Soil Disturbance and Compaction

Once the development envelope is clearly delineated, as discussed in Section 4.2, soil should be disturbed and compacted only within the development envelope. Site fingerprinting, a planning and development practice that focuses on minimizing soil disturbance and compaction, includes techniques such as:

- Delineating a development envelope to reduce compaction of highly infiltrative soils;
- Delineating and flagging the development envelope to minimize soil compaction outside of these areas and restricting storage of construction equipment outside of the development envelope;
- Minimizing the size of the construction easements and material storage areas, and siting stockpiles within the development envelope;
- Utilizing existing open space and maintaining existing topography and existing drainage divides to encourage dispersed flow;
- Limiting clearing and grading activities to the delineated development envelope;
- Avoiding the removal of existing trees and valuable vegetation, where possible; and
- Disconnecting impervious surfaces to increase infiltration and reduce runoff volumes.



**Figure 4-1: Example of soil disturbance minimization**

Locating the development in areas that are not as sensitive to disturbance (e.g., highly erodible soils, steep slopes, etc.) or not as vital to the hydrologic function (e.g., natural drainageways, stream corridors, wetlands, highly infiltrative soils, dense vegetation, etc.), aids in the preservation of the essential hydrology and efficiently utilizes the existing site to prevent and mitigate impacts due to storm water runoff. Siting development away from steep slopes and on less steep terrain that is more amenable to building not only reduces the amount of disturbance but also reduces construction costs due to minimizing cut and fill procedures. Limiting the amount of clearing and grading of native vegetation conserves the soil permeability (i.e., infiltration rate), natural slopes, and drainages as well as existing vegetation.

#### 4.6 Minimize Impervious Surfaces

Conventional development decreases a site's ability to infiltrate runoff by increasing the amount of impervious area. By decreasing the amount of imperviousness, the associated runoff and pollutants generated are automatically reduced. To maintain the essential hydrologic and ecological functions of a site, many different techniques for reducing the overall site imperviousness may be employed, including using alternative layouts for neighborhood design, reducing the building footprints, reducing the impervious area for parking, reducing setbacks and frontages, and increasing permeability of existing soils by amending soils and re-vegetating bare areas. The greatest source of imperviousness in urbanized areas is the transportation



**Figure 4-2: Example of minimizing impervious surfaces by implementing bioretention in a parking lot**

*Photo Credit: Low Impact Development Center*

network including roadways, sidewalks, and parking, including driveways. Using alternative layouts for neighborhood design may not only reduce the overall amount of impervious area but also may decrease costs associated with developing a site (i.e., cut and fill, paving areas, etc.). Laying out roadways with loops and lollipops rather than in a gridiron can decrease the total site imperviousness by up to 26 percent. Narrowing and shortening road sections will reduce imperviousness and will maintain the width of the right-of-way while decreasing the paved portion by replacing the curbs and gutters with a roadside swale. By eliminating curbs and gutters, the capital cost of construction for the street is decreased while increasing aesthetics, water quality, and reducing runoff volume and rate. By limiting sidewalks and on-street parking areas to one side of the road, imperviousness is reduced.

Another method for reducing imperviousness is cluster development which is a technique commonly used for preserving open space and lot yield. This technique requires a thorough walkthrough of the site and examination of hydrologic features and natural resources for delineation of the open space. Once the open space is delineated, the remaining area is divided

into lots that are clustered together with the natural areas preserved as common or non-common open space. Cluster development helps to maintain connectivity between forest patches, preserve interior forest habitat, and avoid impacts to sensitive areas by creating buffer zones between the developed and conserved natural areas (Low Impact Development Center, 2006). In addition, the conserved natural areas can integrate trail systems for use by local residences.



**Figure 4-3: Example of minimizing impervious surfaces in a parking lot**

*Photo Credit: Low Impact Development Center*

lots are slightly more complex due to their larger areas and higher traffic yield. In parking lots, the number and size of the parking spaces may be reduced, shared parking arrangements implemented, structured parking decks built, and alternative permeable pavement installed to reduce the imperviousness. In addition, by designing a parking lot for its projected average peak demand rather than its overall peak demand will use the space more efficiently and decrease its overall footprint and therefore imperviousness. To supplement the reduced size, permeable pavement may be installed adjacent to the lot to accommodate overflow during brief periods of extremely high demand. Sharing parking areas, if feasible, allow for more efficient use of parking space. For example, a church's peak parking demand is on the evenings and on the weekends, whereas a business's peak parking demand may be during weekdays; if they shared a parking lot it would be available for both when needed. Structured parking lots are another alternative that creates more parking spaces while decreasing the amount of imperviousness. Incorporation of landscaped parking lot islands, or regions within or along the edge of a parking lots not only function as aesthetically pleasing landscaping but also function

Building footprints are a major contributor to imperviousness, while lot size may provide some indication of the site's imperviousness, this is also dictated by setbacks and easements required. The impervious area due to buildings may be mitigated by building up, or vertically, rather than out, or horizontally (i.e., a two-story house with 1500 sq. ft. may have about half the impervious area of a single-story ranch style 1500 sq. ft house.)

There are numerous strategies to reduce the amount of imperviousness used for parking. Residential driveways may employ paved strips for tires (See Section 5.11 Ribbon Driveways) rather than a paved pad, a shared driveway arrangement, limited width and/or length, minimized setbacks and materials such as permeable pavement to reduce the amount of imperviousness. Parking

to reduce the overall impervious cover of the lot, and allow for integration of storm water runoff BMPs that increase runoff treatment and assist in maintaining natural hydrologic function by increasing the filtration and detention of runoff before it infiltrates, evapotranspires (i.e., evaporates or is taken up by plants), and/or is directed into a stream or storm water facility. Bioretention areas, tree box filters, vegetated filter strips, and swales can all be used in parking lot islands.

#### 4.7 Disconnect Impervious Surfaces and Utilize Pervious Areas

Connected impervious areas efficiently transport runoff without allowing infiltration. Often in urban areas, runoff from connected impervious surfaces is immediately directed into a storm water conveyance system where it is further connected and efficiently transported to an outfall (storm water conveyance system outlet). For example, roofs and sidewalks commonly drain onto roads, and the runoff is conveyed by the roadway curb and gutter to the nearest storm inlet. Efficient transport due to connected impervious surfaces significantly decreases  $T_c$  while, at the same time, increasing peak runoff discharge rate and volume. Runoff from numerous impervious drainage areas may converge, combining the volumes, peak runoff rates, and pollutant loads. By disconnecting impervious areas and directing runoff to pervious areas,



runoff velocities and volumes decrease and treatment and infiltration occur, thereby increasing  $T_c$ , and potentially reducing pollutant loads due to filtering and infiltration. One of the simplest methods to disconnect impervious surfaces is to disconnect downspouts from roofs and redirect the roof runoff to a pervious area. Disconnection of roof downspouts, roadways, and other impervious areas from storm water conveyance systems allows runoff to be collected and managed on-site or dispersed onto the landscape, thereby reducing the runoff volume and rate and allowing for treatment of pollutants.

**Figure 4-4: Disconnected Downspout Directed to a Pervious Area**

*Photo Credit: Portland Bureau of Environmental Services*

## 4.8 Site Design Examples

This section presents five site design examples that illustrate how site design, basic, and storm water runoff BMPs, may be integrated together for different land use types to achieve the principles of LID. The examples are intended to illustrate how BMP strategies may be incorporated into different types of sites and do not imply any specific requirements as to how a site must be designed. In practice, each site will require a unique combination of site design, basic, and storm water runoff BMPs. Basic BMPs are the only BMP type required for Tier 2 residential projects although the use of site design BMPs as well as storm water runoff BMPs are encouraged, where applicable and practicable. All BMP types are voluntary for Tier 1 projects. Combining several different BMPs distributed across the site and, where feasible, connecting BMPs so the outflow from one BMP is directed to another in a “treatment train”, allows for multiple opportunities to increase infiltration, water storage, and filtration. The examples shown in this section are:

- Single-family residential
- Multi-family residential
- Commercial development
- Office building
- Residential Street
- Parking lots are included in several of these examples.



### ***4.8.1 Single-Family Residential***

Single-family residential properties offer many opportunities for the implementation of LID principles and practices. Whether the project is a single single-family residence or a neighborhood of single-family residences, site design BMP options used in combination with basic BMP options and storm water runoff BMP options can allow for integration of LID principles and practices that are applicable for various site conditions and storm water, water conservation, and landscaping objectives, cost, and aesthetic goals.

When designing a sub-division, more care must be taken to consider all of the constraints of implementing BMP options. Long-term maintenance and public health and safety are major concerns. Some simple practices that may be incorporated into each lot are all of the site design BMP options discussed in this chapter, as well as disconnected downspouts, soil amendments, and larger scale storm water runoff BMPs. Smaller lot scale BMPs may be implemented but require more homeowner education including how on-lot BMPs function, which BMPs are appropriate, what kinds of maintenance are required, and the frequency that maintenance inspections should be conducted. Figure 4-5 illustrates a single-family residential example with the following BMP options:

Site design BMP options (Chapter 4) illustrated:

- Conserve and restore natural areas
- Maintain, restore and utilize natural flowpaths
- Site BMPs on infiltrative soils
- Minimize impervious surfaces
- Disconnect impervious surfaces and utilize pervious areas

Basic BMP options (Chapter 5) illustrated:

- Disconnect Downspouts
- Flow Spreading
- Rainwater Garden
- Rain Barrels
- Soil Amendments

Storm water runoff BMP options (Chapter 6) illustrated:

- Bioretention
- Vegetated Swale Filter
- Permeable Pavement

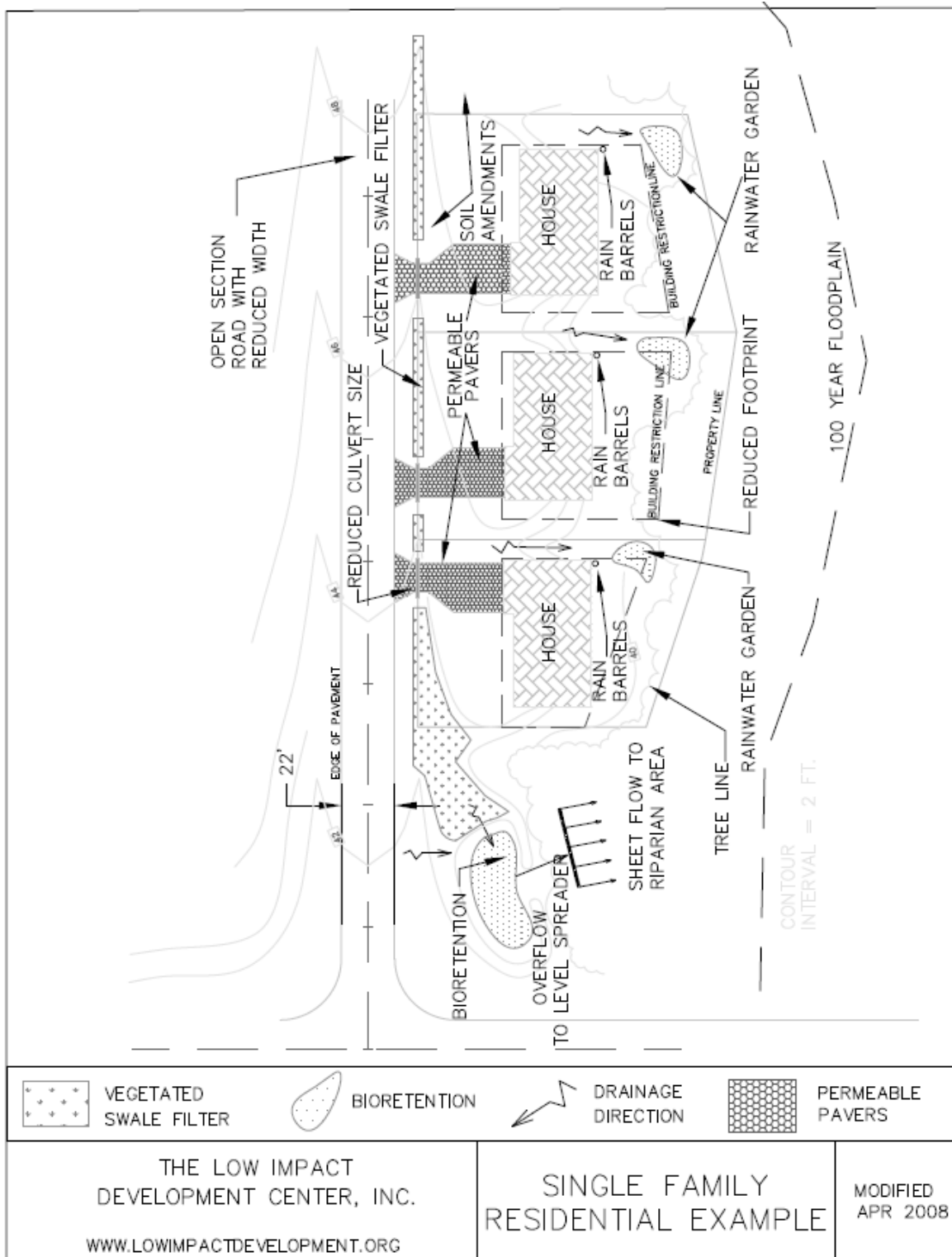

Figure 4-5: Single-Family Site Design Example

### ***4.8.2 Multi-Family Residential***

Multi-family residential sites present challenges and opportunities similar and dissimilar to single-family residential sites. Multi-family residential lots tend to have a higher impervious to pervious ratio and are usually larger in scale; thereby limiting the value of implementing some smaller scale basic BMP options, such as rain barrels and rainwater gardens. However, due to the larger impervious surfaces of buildings and parking lots, there are additional storm water runoff BMPs that may be considered (i.e., cisterns and permeable pavement). By utilizing cisterns (large aboveground rain barrels or underground storage tanks), downspouts are disconnected and the large impervious area becomes a valuable, multi-benefit water conservation tool for storing runoff water for later use in irrigating landscaped areas. The additional space available makes multi-family residential sites more amenable to vegetated swale filters that may border the site providing landscaping and storm water filtering, infiltration, and conveyance. Figure 4-6 illustrates a multi-family residential example with the following BMP options:

Site design BMP options (Chapter 4) illustrated:

- Conserve and restore natural areas
- Maintain, restore and utilize natural flow paths
- Minimize impervious surfaces
- Disconnect impervious surfaces and utilize pervious areas

Basic BMP options (Chapter 5) illustrated:

- Disconnect Downspouts
- Soil Amendments

Storm water runoff BMP options (Chapter 6) illustrated:

- Bioretention
- Vegetated Swale Filter
- Permeable Pavement
- Planter Box
- Green Roof

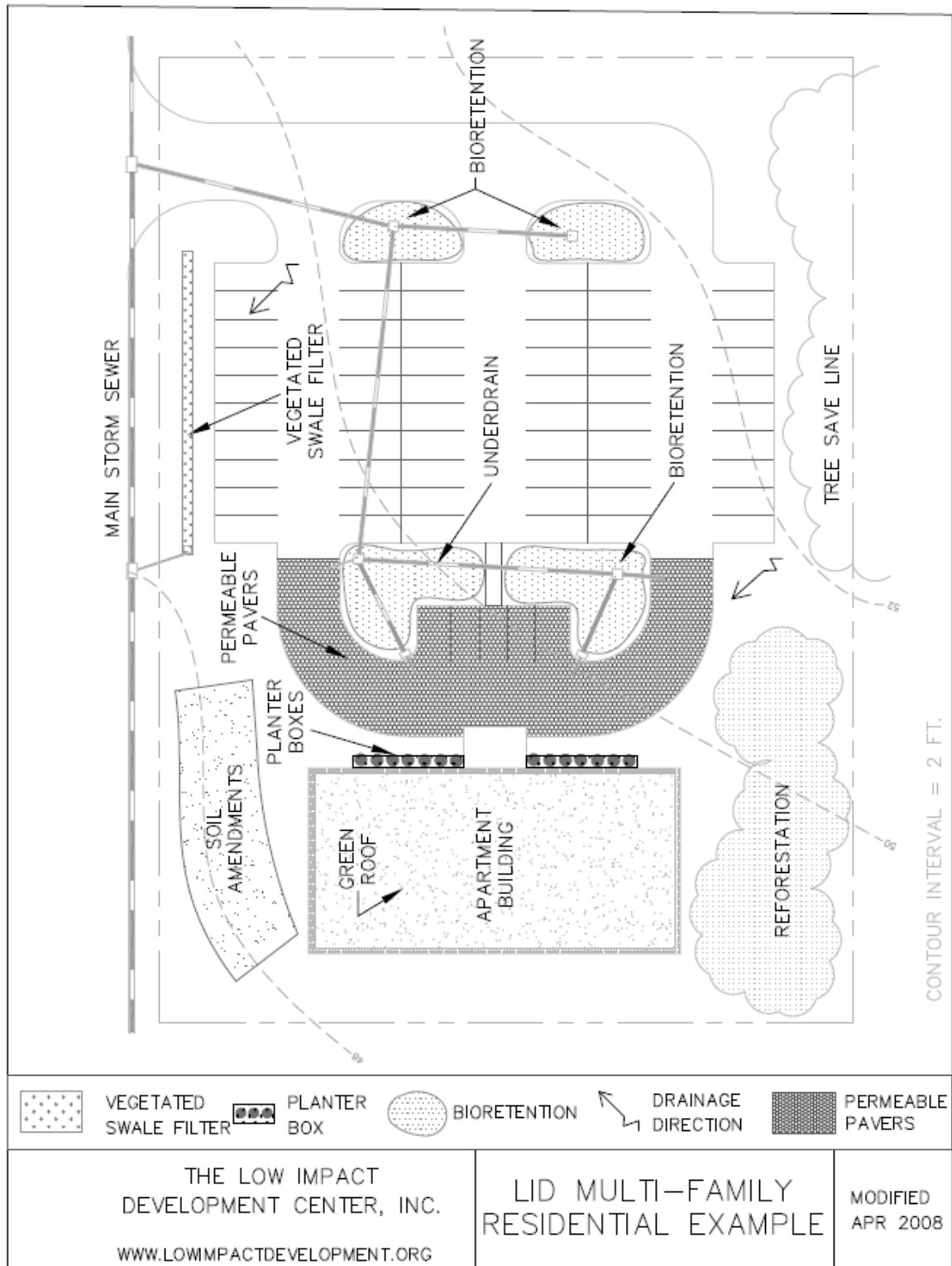

Figure 4-6: Multi-Family Residential Site Design Example

### 4.8.3 Commercial Development

Commercial developments offer numerous opportunities for implementing LID principles and practices, especially in parking areas and on rooftops. Commercial lots have large areas devoted to providing parking for employees and customers and, with a few modifications, become excellent locations for implementing site design, basic, and storm water runoff BMPs and also enhancing the aesthetics of the site. The largest reduction in impervious area created by installing parking lots may be accomplished by using a permeable pavement option, such as permeable asphalt, pervious concrete, or permeable pavers. Permeable designs and products must be chosen carefully, as some can warp and/or shift in high traffic areas or areas where vehicles frequently turn. In addition, impervious parking lots may be designed to drain into landscaped islands designed to house bioretention facilities that provide not only volume reduction, slowing of runoff, and water treatment but also shade for the parked cars as well as enhance the aesthetics of an otherwise sun exposed, impervious landscape lacking aesthetic appeal. Landscaped areas may also be incorporated around buildings and in courtyards, thereby reducing imperviousness as well as creating areas for employee use and/or screening around the property.

Commercial rooftops may be installed as green roofs (vegetated roofs) to absorb some of the precipitation and reduce runoff volumes. Rooftops may also be constructed with traditional gutters that direct water to downspouts; however, the downspouts may be connected to planter boxes or cisterns for direct or indirect irrigation of landscaping. Figure 4-7 illustrates a commercial development example with the following BMP options:

Site design BMP options (Chapter 4) illustrated:

- Conserve and restore natural areas
- Site BMPs on infiltrative soils
- Minimize impervious surfaces
- Disconnect impervious surfaces and utilize pervious areas

Basic BMP options (Chapter 5) illustrated:

- Disconnect Downspouts

Storm water runoff BMP options (Chapter 6) illustrated:

- Bioretention
- Vegetated Swale Filter
- Permeable Pavement
- Cistern
- Planter Box
- Green Roof
- Proprietary Devices

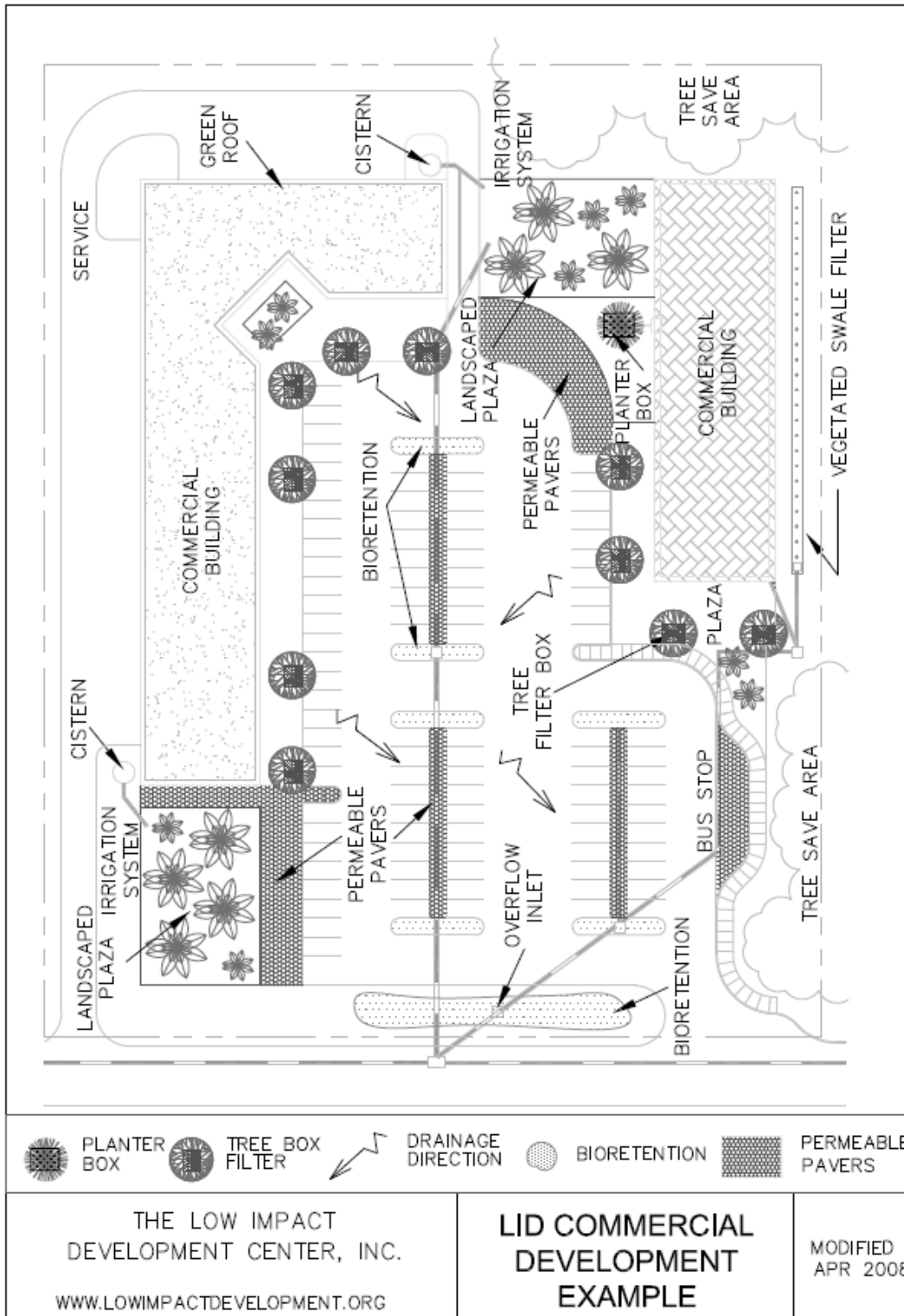

Figure 4-7: Commercial Site Design Example

#### 4.8.4 Office Building

Office parks, like commercial developments, have numerous opportunities for implementing onsite storm water management techniques during new development and redevelopment projects. Areas such as courtyards that may have been paved/cemented when initially installed may be redeveloped and in the process natural areas restored. An area surrounding the development that may have been compacted and/or damaged during the construction may be restored. These surrounding areas offer a great opportunity in that they are not currently being used and may be an eyesore. By amending the soil, which may only involve tilling and planting native vegetation, increases the infiltration capacity of the site. In addition, like commercial developments, office parks have large areas comprised of rooftops and parking lots (see section 4.8.3) that may be used to integrate storm water management techniques. Figure 4-8 illustrates an office building example with the following BMP options:

Site design BMP options (Chapter 4) illustrated:

- Conserve and restore natural areas
- Maintain, restore and utilize natural flowpaths
- Site BMPs on infiltrative soils
- Minimize impervious surfaces
- Disconnect impervious surfaces and utilize pervious areas

Basic BMP options (Chapter 5) illustrated:

- Disconnect Downspouts
- Flow Spreading
- Rainwater Garden
- Rain Barrels
- Soil Amendments

Storm water runoff BMP options (Chapter 6) illustrated:

- Bioretention
- Vegetated Swale Filter
- Permeable Pavement

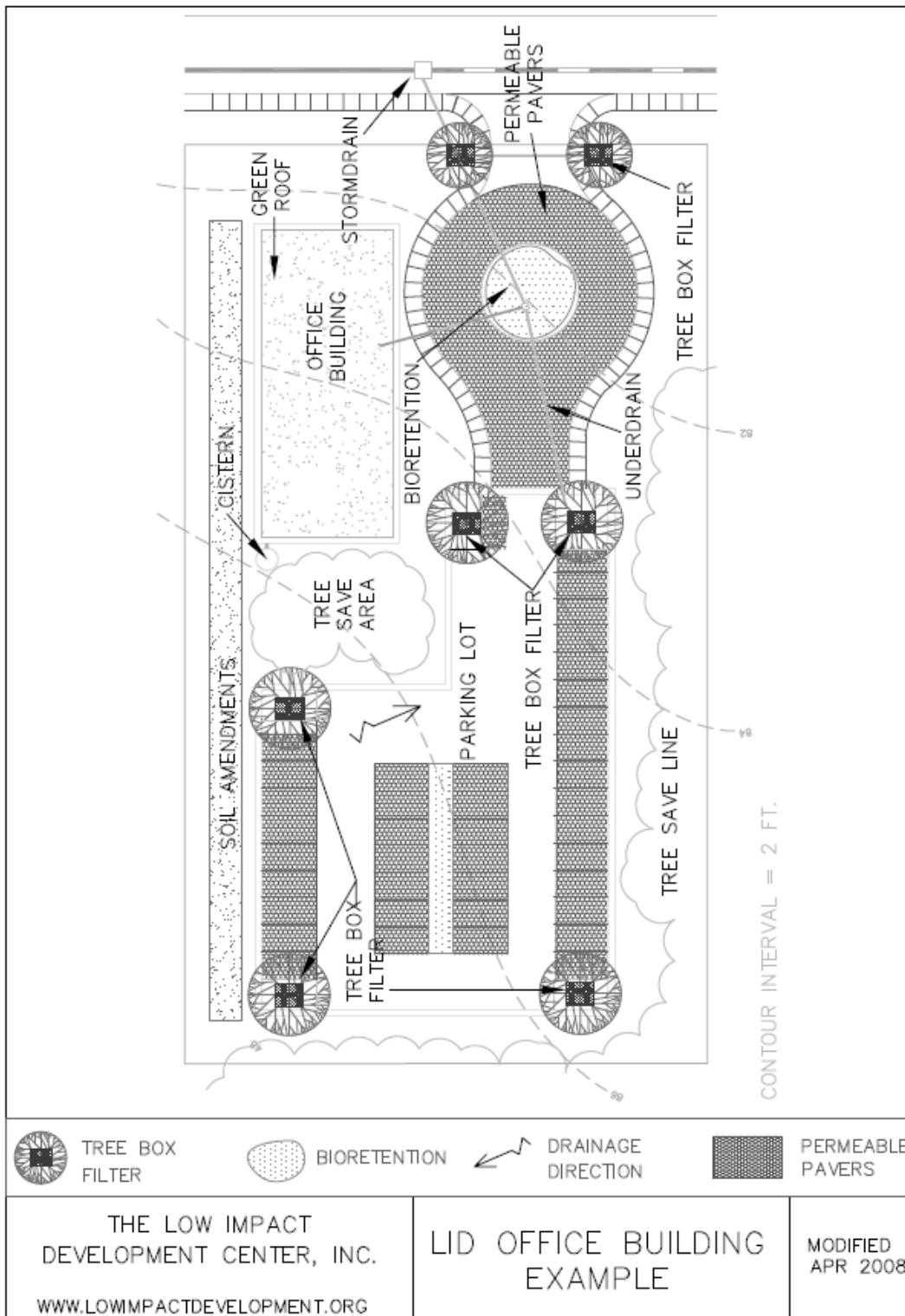

Figure 4-8: Office Building Site Design Example



#### 4.8.5 Residential Street

Residential streets may incorporate storm water management techniques for treating residential runoff. For example, a roadside ditch may be easily converted into a swale that will treat runoff as it is conveyed to the storm water conveyance system or other storm water management facility. An alternative method is to use a portion of the street in a way that enhances the aesthetics of the neighborhood, reduces impervious area, acts as a traffic calming device and treats local runoff. An example (Figure 4-9) of how the street may be used is shown below. The figure shows how a “planter box” was created on the side of the street by the addition of a curb that has openings on it to let storm water in at one end and along the way, and out at the other. This flow-through type planter box acts as a pretreatment step before the storm water enters the storm water conveyance system. In addition, it decreases the velocity and time of concentration.

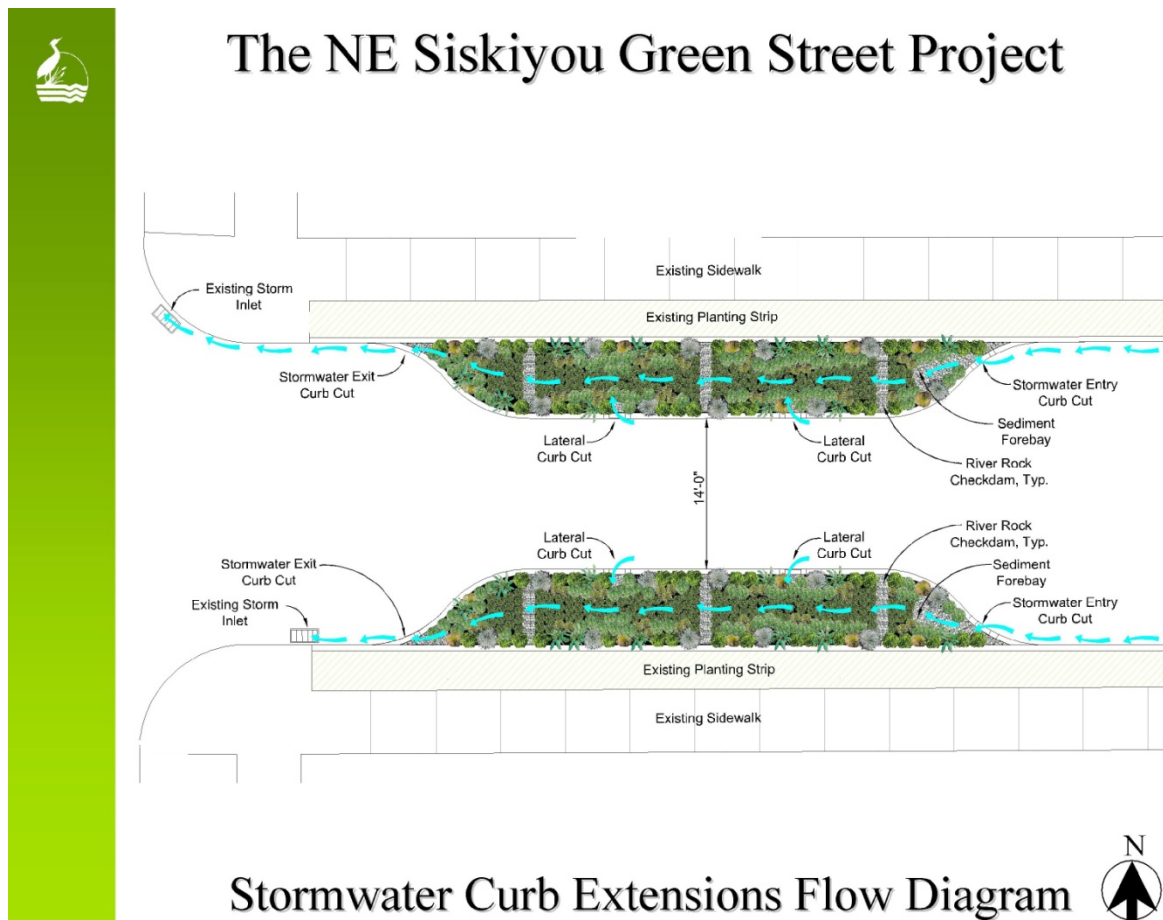

Figure 4-9: Residential Street Design Example

## 5 BASIC BMP OPTIONS

Several of the Basic BMPs recommended in this chapter are common landscaping practices for home lawns and garden and all are intended for easy and aesthetic implementation. Additional internet references are provided for more information:

[http://www.santabarbaraca.gov/Resident/Water/Water\\_Conservation/WCLandscaping.htm](http://www.santabarbaraca.gov/Resident/Water/Water_Conservation/WCLandscaping.htm)

[http://www.santabarbaraca.gov/Resident/Water/Water\\_Conservation/WCEducation.htm](http://www.santabarbaraca.gov/Resident/Water/Water_Conservation/WCEducation.htm)

[http://www.santabarbaraca.gov/Resident/Water/Water\\_Conservation/WCBrochuresandmore.htm](http://www.santabarbaraca.gov/Resident/Water/Water_Conservation/WCBrochuresandmore.htm)

<http://www.santabarbaraca.gov/Resident/Community/Creeks/Pesticides.htm>

[http://www.santabarbaraca.gov/Resident/Community/Creeks/Low\\_Impact\\_Development.htm](http://www.santabarbaraca.gov/Resident/Community/Creeks/Low_Impact_Development.htm)

### 5.1 How to Choose Basic BMPs

After the site has been assessed and possible locations for BMPs identified, it is time to identify which BMPs may be appropriate for the site. Tier 3 projects are required to have a detailed soil and site analysis completed, as discussed in Chapter 3. However, Tier 1 and Tier 2 projects may opt to perform simple infiltration and soil tests to determine if the site is amenable to infiltrative BMPs, which types of vegetation will live in such conditions, and if soil amendments would aid in improving water quality and the infiltration capabilities of the site; all of these items are addressed in this chapter. The basic BMP options in this chapter are easier to implement than those in Chapter 6 and are more appropriate for implementation by individual homeowners (Tier 1 and Tier 2 projects). The basic BMP options are also intended for implementation by Tier 3 projects, where applicable.

While all of the BMPs in this section will contribute to reducing storm water runoff volume, rate, and/or pollutants from the site, they are not adequate to meet the storm water runoff requirements as outlined in Chapter 6. However, since all of the basic BMPs mitigate the effects of storm water runoff and lessen the burden of required treatment and hydrologic control, these BMPs implicitly reduce the storm water runoff requirements in Chapter 6 and should be considered a critical component of implementing LID principles at any site. There are a variety of basic BMPs available providing options for designers to achieve site-specific customization based on site constraints, local topography, design standards, and climate. Basic BMPs:

- Contribute to a location's aesthetic appeal,
- Aid in water conservation,
- Protect local creeks and oceans from pollution carried by storm water runoff,
- Reduce a site's water usage and costs, and
- Create wildlife habitat.

Table 5-1 compares the different BMPs in this chapter based on their ease of implementation, relative cost, and soil infiltration requirements.

**Table 5-1: Matrix Table for Comparison of Basic BMP Options**

**Important Note to User:** Site suitability can vary widely for individual BMPs. This table should be used to provide general BMP comparisons only.

| Manual Section | Basic BMP Option           | Ease of Implementation <sup>1</sup> | Relative Cost <sup>2</sup> | Infiltration Capacity Requirement <sup>3</sup> | Suitable for site with slope >15% |
|----------------|----------------------------|-------------------------------------|----------------------------|--|-----------------------------------|
| 5.3            | Disconnected Downspouts    | 2                                   | \$                         | Y  | Y/N                               |
| 5.4            | Flow Spreading             | 2                                   | \$-\$\$\$                  | Y  | N                                 |
| 5.5            | Rain Gardens               | 4                                   | \$-\$\$\$                  | Y  | N                                 |
| 5.6            | Rain Barrels               | 2                                   | \$-\$\$\$                  | Y/N  | Y                                 |
| 5.7            | Contained Planters         | 1                                   | \$-\$\$\$                  | N  | Y                                 |
| 5.8            | Depression Storage         | 4                                   | \$-\$\$\$                  | Y  | N                                 |
| 5.9            | Permeable Pavement         | 2                                   | \$\$-\$\$\$                | Y  | N                                 |
| 5.10           | Soil Amendments            | 3                                   | \$-\$\$\$                  | Y/N  | Y                                 |
| 5.11           | Landscaping Considerations | 1                                   | \$-\$\$\$                  | Y/N  | Y                                 |

|   |      |                |        |                     |
|---|------|----------------|--------|---------------------|
| 1 | Easy | Easy to Medium | Medium | Medium to Difficult |
|   | 1    | 2              | 3      | 4                   |

|   |          |            |             |                 |
|---|----------|------------|-------------|-----------------|
| 2 | \$0-\$50 | \$50-\$100 | \$100-\$500 | more than \$500 |
|   | \$       | \$\$       | \$\$\$      | \$\$\$\$        |

<sup>3</sup> Y - infiltration capacity required for BMP implementation;  
 N - Infiltration capacity is not a concern for implementation;  
 Y/N depends on how it is implemented

## 5.2 Site Assessment (*recommended for Tiers 1 and 2; this assessment is NOT intended for Tier 3 projects*)

### 5.2.1 Soil Assessment

An important step in assessing your site for determining which BMPs are applicable or will perform as desired is to assess your soils. A soil assessment helps determine if the soils at the site exhibit enough infiltration for infiltrative BMPs to function successfully and helps characterize the types of soil present. This assessment allows you to determine if an infiltrative BMP will work at your site and may also aid in determining which types of vegetation will thrive at your site.

### 5.2.2 Simple Infiltration Test

To determine if there is adequate infiltration at your site for implementing an infiltration BMP, it is necessary to conduct a simple infiltration test as described in the following steps.

1. Dig a hole about 6 inches deep
  - a. Make sure that the hole does not show any evidence of macropores (i.e., tunnels dug by burrowing animals, rotted tree trunks, etc.). If macropores are present, an alternative location should be chosen for the simple infiltration test because you will be measuring the capacity of the macropore rather than the infiltration of the soil.
2. Fill the hole with water
  - a. If the water does not soak in within 24 hours then it is not feasible to implement an infiltration BMP.

### 5.2.3 Simple Texture by Feel Test

Determine the type of existing soil by conducting a simple texture by feel test. Knowing the soil type will allow you to determine which options will be most effective, including vegetation and soil amendments. The following steps will help determine the existing soil type.

1. Grab a handful of soil
2. Add a bit of water to the soil while kneading it to distribute the moisture
  - a. As you are kneading the soil it should eventually feel like putty and form a ball
  - b. If it never reaches this point and it feels gritty, your soil is mostly sand and therefore offers good infiltration.
3. Once the soil forms a ball when kneaded, hold it in the palm of one hand and begin rolling it with the fingers of the other hand into a coil about 1/10" thick. Allow the coil to drape over the edge of your finger as it gets longer.
  - a. If the coil is less than 1 inch when it breaks your soil is sandy loam
  - b. If the coil is longer than an inch, examine the soil more closely.
    - i. Does it feel sticky, look shiny, and form a very long coil without breaking?
      1. Then it is more clay than loam
    - ii. Does it feel soft, not sticky, and look dull? Does the coil break?
      1. Then it is more loam than clay
    - iii. If your soil is more clay **OR** more loam (i.e., more sticky or more soft)
      1. Does it feel gritty/sandy at all?
        - a. Sand is present
      2. Does it feel like smooth like flour?
        - a. Silt is present
4. Most soil is a combination of clay, silt, and sand. Soils that form long coils and feel sticky or smooth tend to hold more water and therefore if your soil has these characteristics, then infiltration BMPs are not appropriate for your site. Chances are that the water will not completely drain from the hole in the specified amount of time (24 hours). Try it and see. Soils that feel gritty and soft probably are good candidates for infiltration; check to see that they infiltrate as required by performing the simple infiltration test described above.

### 5.2.4 Site Slope Assessment

#### Simple Slope Measurement

To measure the slope for the purposes of determining if the location is amenable to certain BMPs (i.e., those that require the slopes to be less than 15%) follow the instructions below.

Mark out the area to be measured, place a stick at the top (upslope) point and another at the bottom (downslope) point.

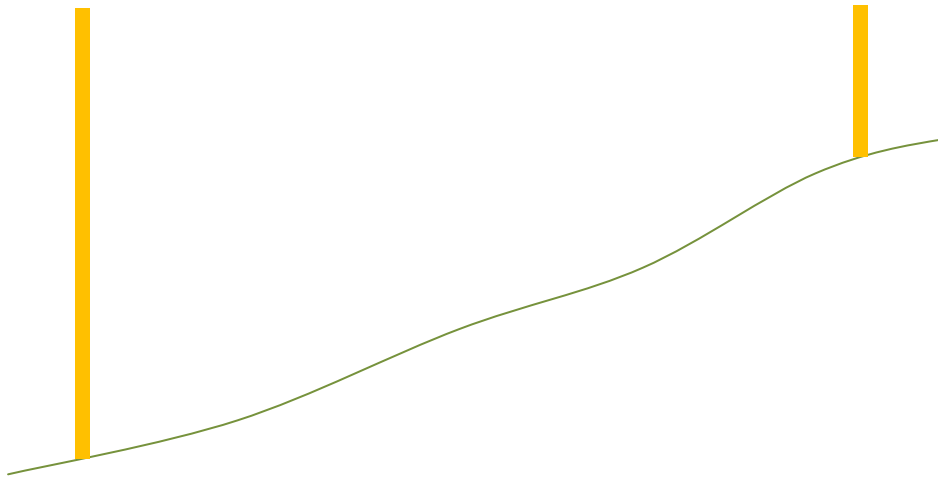

Once the marking sticks are in place, it is time to attach a string (that is long enough to reach between both of the sticks) to the base of the upslope stick.

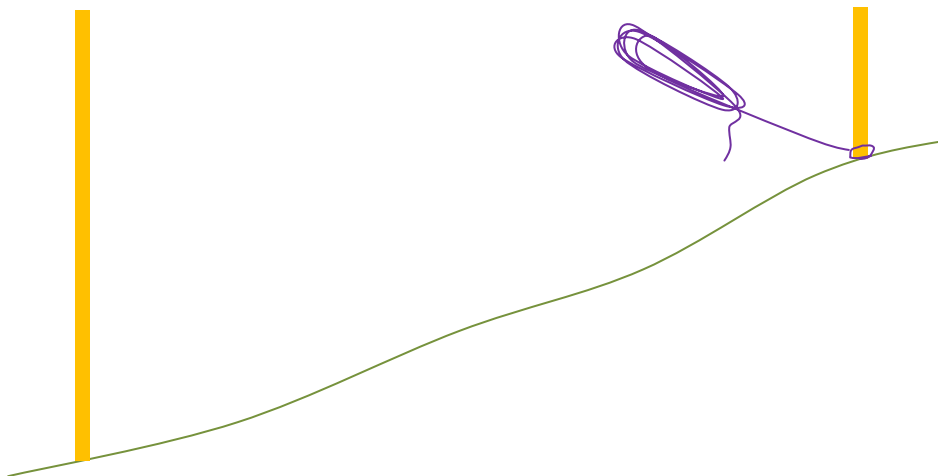

Stretch the string from the downslope side and affix. Before conducting any measurements ensure that the string is level.

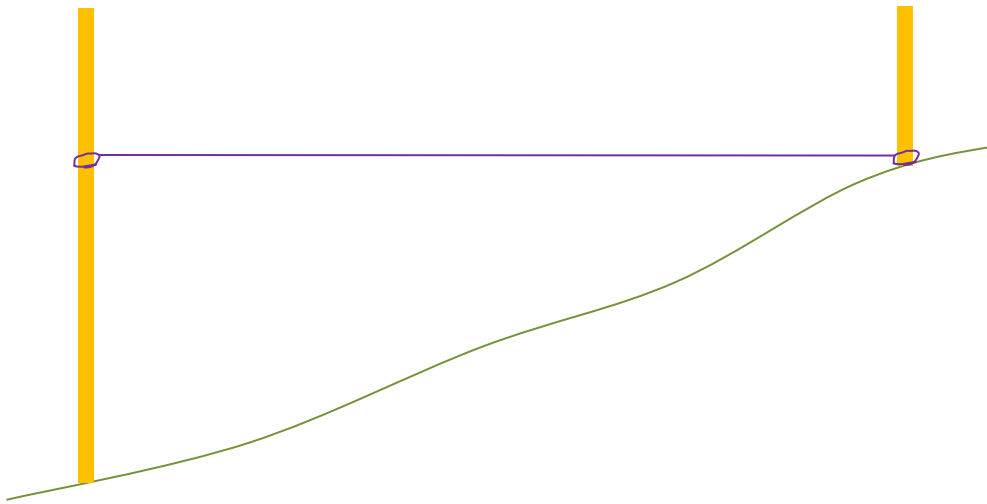

Measure:

The length of the string that is stretched between the sticks.

The height of the string on the downslope stick (from ground level to string level).

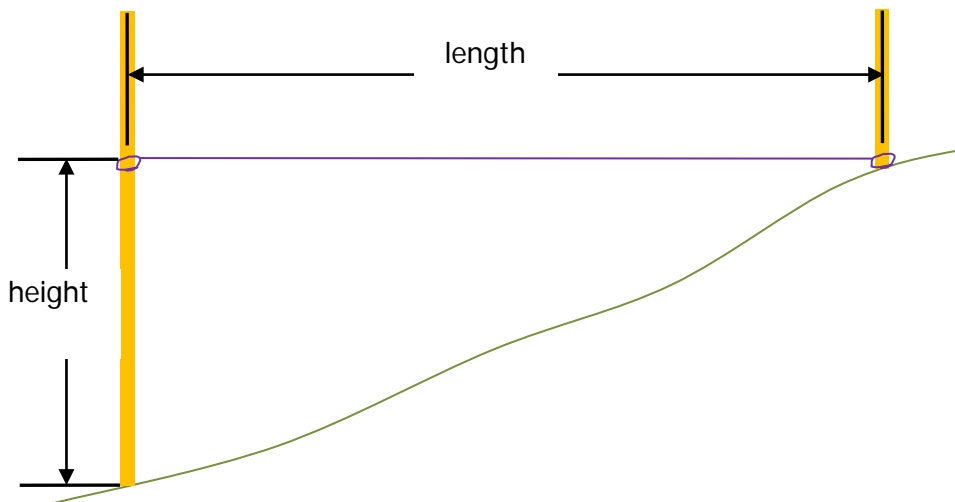

Calculate the percent slope

Percent slope = difference in height between the two sticks divided by the distance between sticks. Both measurements need to be in the same measurement units. For example, if the distance between the two sticks is 5 feet and the height is 6 inches, the 6 inches should be divided by 12 (for the number of inches in a foot) to change from inches to feet; therefore, the height equals 0.5 feet. The % slope is equal to .5 feet divided by 5 feet multiplied by 100%, which equals a slope of 10%.

$$\% \text{ slope} = \frac{\text{Height}}{\text{Length}} \times 100\%$$

### 5.2.5 Roof Area Assessment

This section provides guidance for estimating the impervious area of your roof that drains to the different downspouts located around your house.

1. Sketch the footprint of your house
2. Indicate the length of each side

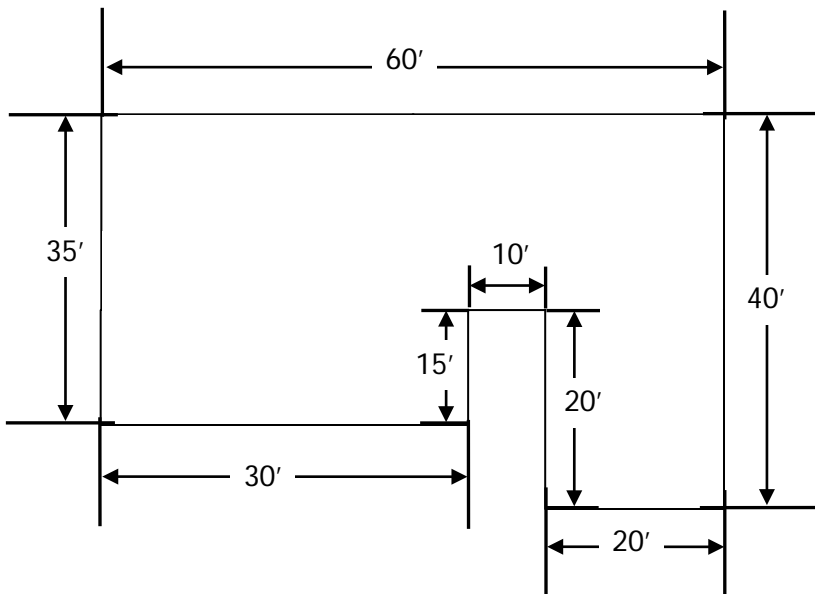

3. Identify locations of downspouts

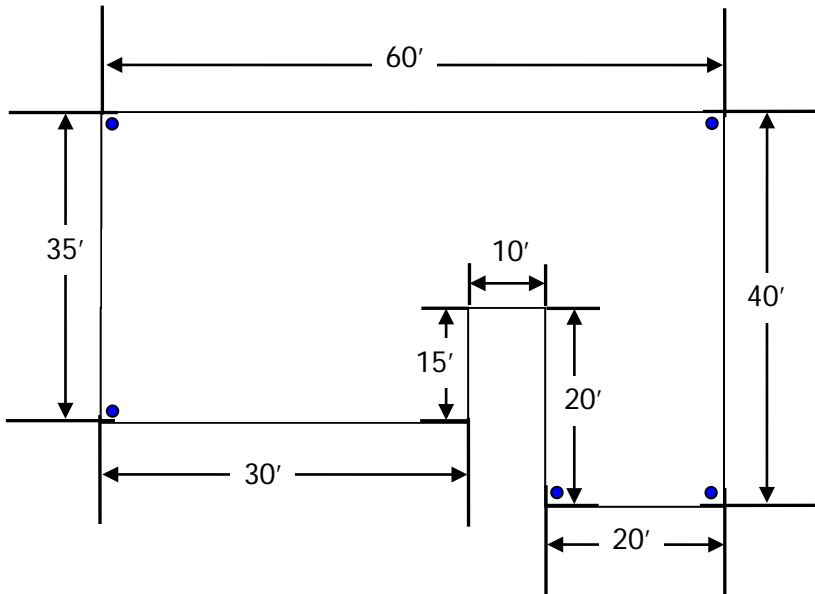

4. Delineate the ridges of the rooftop

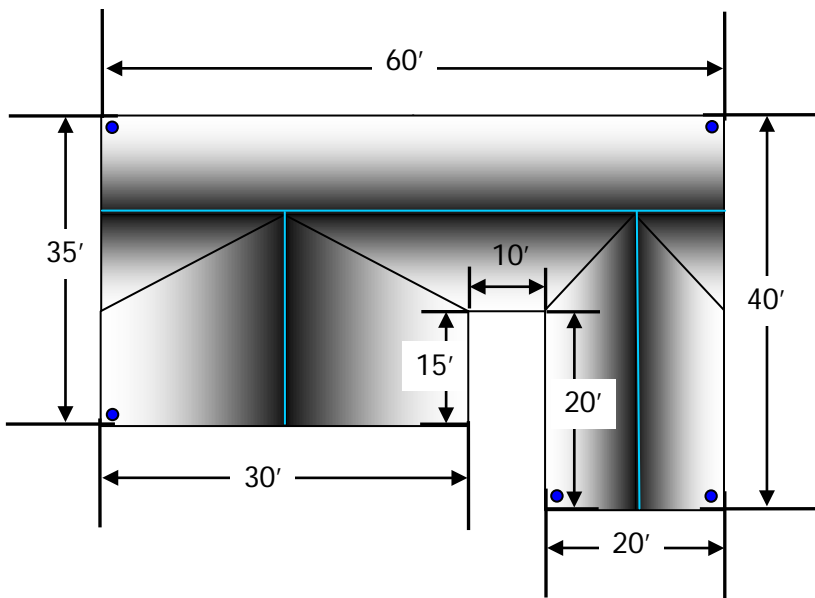



- a. If the ridges intersect any of the sides, measure and indicate on sketch approximate distance from ridge to each of the closest downsports

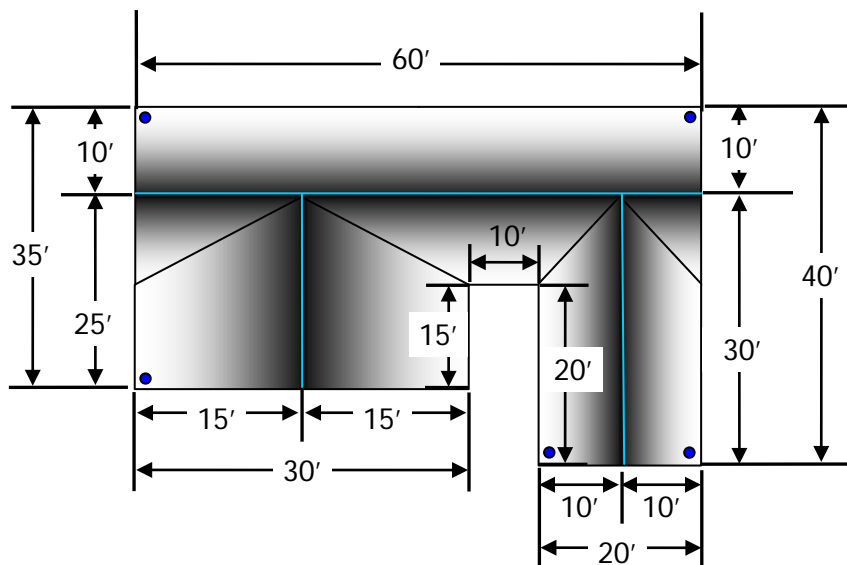

5. Determine the flowpaths to each of the downsports (i.e., identify which areas flow to each downspout)
- a. If an area is connected to two downsports, assume that half of the area drains to each (see the top area in the figure below)
- i. **Note:** The blue arrows indicate the direction of flow from roof ridges to gutters, while the green arrows indicate the flow direction through the gutters to the downsports

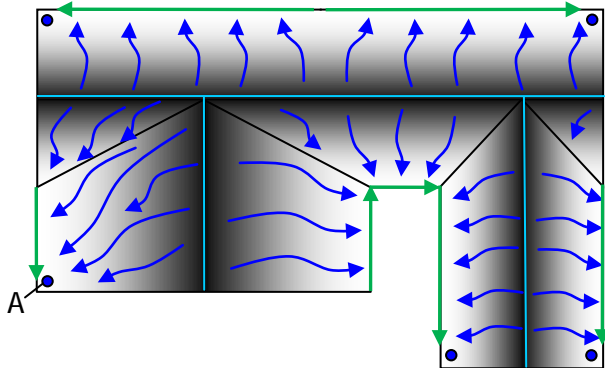

6. For each downspout calculate the area that is draining to it
- For example, to calculate the area that is draining to downspout A, use the lengths shown in step 3a.
- $15' \times 25' = 375 \text{ sq. ft.}$  (This is the area that contributes runoff to downspout A)

### 5.3 Disconnect Downspouts



**Figure 5-1: Example of disconnected downspout that directs runoff to pervious area**

later use. In contrast, conventional systems that directly connect roof runoff to storm water conveyance systems can have significant environmental impact. The storm water in the conveyance system has higher velocity, volume, and pollutants than runoff from pervious vegetated areas. In Santa Barbara, the storm water conveyance system is not connected with the sanitary sewer treatment system. Instead, storm water exits the conveyance system into the creeks and ocean untreated. The high velocity, volume, and pollutants exiting the conveyance system into streams and ditches can have a significant environmental impact by eroding stream channels and harming aquatic life.

#### *How do I disconnect my downspouts?*

Prepare a plan for your site by following these steps:

1. Observe the existing conditions
  - a. Are your downspouts draining to your lawn already? Or are they connected to the storm water conveyance system (look to see if the downspouts connect to impervious areas (e.g., a driveway, a street, gutters) or pipes underground that direct the runoff to storm drains)? Or do the downspouts

#### *What is disconnecting downspouts?*

Disconnecting downspouts diverts water from roof gutters to (1) vegetated pervious areas of the site in order to allow for infiltration, storage, evapotranspiration (i.e., evaporation and uptake of water by plants), and treatment, or (2) a rainwater collection system (e.g., rain barrel). Disconnected downspouts differ from conventional downspout systems that provide a direct connection of roof runoff to storm water conveyance systems (storm drains), which quickly collect and convey storm water away from the site.

#### *How does disconnecting downspouts aid in storm water management?*

Disconnecting downspouts decreases the amount of runoff entering the storm water conveyance system and reduces pollution carried by storm water. In addition, the runoff may be put to better use if it is directed to your lawn or garden or is captured in a rain barrel for

drain into another type of storm water management system (i.e., drywell, soakage trench, rain barrel, etc.)?

2. Prepare a sketch of your site
  - a. Include locations of existing downspouts
  - b. Delineate which portions of the roof drain to which downspout and estimate the area that drains to each downspout (see Section 5.2.3 for methods of calculating areas that drain to each downspout)
  - c. Indicate locations where disconnecting a downspout may cause a hazard (e.g., disconnection would cause runoff to cross a walkway or driveway, damage a structure, site slopes exceed 15%, etc.)
  - d. Indicate the locations of retaining walls, septic systems and their drain fields, underground oil tanks, and any areas where the surrounding landscape slopes towards the house
  - e. If roof runoff will be directed to pervious vegetated area, delineate areas where downspouts may be diverted to:
    - i. Estimate the pervious vegetated areas available for the diverted runoff to soak in
    - ii. Downspouts should be diverted to areas where they will have enough capacity for the rain to soak in; at least 10% of the area that is draining to it
3. Consider directing runoff from downspouts to one or more other Basic BMP options (e.g., rainwater gardens, or rain barrels) or Storm Water Runoff BMP options (see Chapter 6). This may increase your ability to disconnect downspouts based on site conditions. Disconnected downspouts when used in combination with other BMPs can allow runoff to be: (1) collected away from a foundation and infiltrated; (2) diverted away from foundations, spread out and infiltrated; or (3) collected and stored for on-site reuse (see Section 5.6 for Tier 1 and 2 projects and Section 6.9.1 for Tier 3 projects for more information on rain barrels and cisterns).
4. Obtain materials needed for disconnection:
  - a. Tools: Tape measure, Hacksaw, Drill, Pliers, Screwdriver
  - b. Elbow (<90°)
  - c. Downspout extension (if applicable)
  - d. Plug or cap for the standpipe (if applicable)
5. If roof runoff will be directed to vegetated pervious areas or other Basic or Storm Water Runoff BMP options other than rain barrels and cisterns:
  - a. Design the downspout to be:
    - i. Equipped with an elbow at the outlet to direct runoff sufficiently far (4 to 6 feet) from the foundation to prevent foundation damage and basement flooding

- ii. Protected at the outlet of the elbow with a type of energy dissipation (e.g., splash blocks – see Section 5.4)
  - b. Plan to add a gutter extension to the elbow or design a conveyance channel to direct the runoff from the elbow to vegetated pervious areas or other BMP(s):
    - i. Direct runoff at least 10 feet away from foundations (including the neighbor's foundation) using a downspout extension, rock or vegetated channel, flow spreading (see Section 5.4), other method, or combination of methods that protects against erosion.
  - c. Design the vegetated pervious area or other BMP
    - i. Ensure that the location you are diverting the runoff to is of adequate size. If you are choosing to combine disconnected downspouts with another BMP, make sure you have designed and checked the feasibility of implementing the other BMP on-site prior to assuming that the water from the downspout will be diverted to that BMP.
6. If roof runoff will be directed to a rain barrel (Tier 1 and Tier 2 projects), go to Section 5.6 for more information on sizing and installation. If roof runoff will be directed to a cistern (i.e., a large rain barrel) for Tier 3 projects, go to Section 6.9.1.
7. Steps for disconnecting your downspouts
  - a. Locate where you will cut the downspout
    - i. Should be a minimum of 9" above ground level to ensure that there is enough of a slope downward to drain all of the water. However, if you choose to combine with another BMP you may need to adjust where you cut the downspout (check the design constraints of the other Basic and Storm Water Runoff BMPs)
  - b. Use a hacksaw to cut the downspout
  - c. Attach (with screws or other fastening method) the elbow. Make sure the elbow fits around the outside of the downspout to prevent leaks.
  - d. Install some type of energy dissipation at the outlet of the elbow (e.g., splash block, river rock).
  - e. If applicable, install a downspout extension, rock or vegetated channel, flow spreader (See Section 5.4), or other conveyance method to direct runoff away from the foundation and/or towards another BMP. If using a downspout extension, attach the extension with screws or other fastening method. Again, make sure that the extension fits around the outside of the elbow.

### ***Maintenance Considerations***

Annually conduct the following activities:

- Check to see that connections are not leaking; if they are, repair the joints
- Caulk any leaks or holes that are found

- Inspect for any damage on the downspout components
- Check to make sure there are not any clogs
  - Clear any buildup in elbows and gutters; this may need to be done more frequently if there are overhanging trees
- Check to make sure that the conveyance system of the roof runoff is adequately protecting the underlying soil. If rock has been displaced or vegetation eroded and bare spots are evident, replace the rock or add new rock or vegetation to adequately cover the bare spots.

## 5.4 Flow Spreading

### *What is flow spreading?*

Flow spreading is a technique that spreads runoff out over a vegetated pervious area, rather than concentrating and conveying the runoff to a storm water conveyance system (storm drain inlets and drain pipes).

### *How does it aid in storm water management?*

Flow spreading distributes concentrated runoff over a larger grassed or vegetated pervious surface, which allows runoff to infiltrate more efficiently than the limited surface in a swale or channel. In addition, when spreading occurs over a grassed or vegetated area, the runoff is infiltrated or filtered by the vegetation and the spreading minimizes risk of erosion. Excess runoff that is not infiltrated flows across the flow spreading area, thereby decreasing the travel time of the runoff and can be directed towards a natural area or a storm water conveyance system. Runoff infiltration can be enhanced when flow spreading is used in combination with soil amendments (see Section 5.10).

### *What applications are best?*

Flow spreading is a versatile practice that may be employed in a variety of ways and in a variety of locations. It may be used to spread and infiltrate runoff from driveways, disconnected roof downspouts, and other open surfaces, either pervious or impervious.

### *How do I accomplish flow spreading?*

While there are a variety of devices to promote the spreading of runoff, they all require runoff to flow over a vegetated path or gravel/rock bed for a specified distance (depending on device). The path slows, filters, stores, infiltrates, and spreads the runoff. Some devices commonly used for flow spreading are splash blocks, rain drains, and rock pads.



**Figure 5-2: Flow Spreading - Directing runoff from a disconnected downspout away from a foundation (University of California, Santa Barbara)**

### *Splash blocks*

Splash blocks are the simplest of the devices and are generally used to spread concentrated runoff from disconnected downspouts and may be used in conjunction with a conveyance channel (e.g., rock or vegetated) or a downspout extension to move water away from the foundation. Downspout extensions are available commercially (at hardware stores) in a variety of materials and styles and cost between \$5 (plastic) and \$100 (pre-cast cement).

### *Rain Drains*

Rain drains are plastic tubes that attach to downspout extensions that direct runoff away from the foundation and contain holes that spread the runoff out by acting like a sprinkler head. Some have metal coils that retract when there is not enough runoff to fill the tube and extend when runoff begins to fill the tube. They are available commercially (at hardware stores) for less than \$10.

### *Rock Pads*

Rock pads are constructed with crushed rock and oriented perpendicular to the direction of runoff. Typically rock pads are used next to driveways to accommodate driveway runoff, especially if other impervious areas drain to the driveway. A rock pad should be 2 feet wide by 3 feet long and six inches deep. Rock pads need to be constructed on-site and should use clean rock.

## ***Design Considerations***

1. No more than 700 square feet of impervious surface may drain to a single flow spreader (of those mentioned in this section)
2. Vegetated flow path must be:
  - a. At least 50 feet long
  - b. Well-established with lawn or other dense groundcover
  - c. No steeper than 15% (see Section 5.2.2 for estimating site slope)
  - d. Located between the flow spreader and any downstream drainage; the vegetated flow path may be located within a critical buffer area, though flow spreaders themselves are NOT permitted within a critical buffer area
3. The spreading of flow must not create any flooding or erosion problems
4. Sites with septic systems should locate the vegetated flow path down slope of primary and reserve drain fields

## ***Maintenance Considerations***

Annually, the following maintenance activities should be conducted:

1. Inspect for any damage to the flow spreader, repair if required
2. Inspect vegetated flow path to ensure that vegetation is uniformly distributed and provides dense cover; revegetate areas that do not meet this requirement
3. Repair signs of erosion immediately by using temporary erosion control until vegetation can be established
4. Check to make sure there are not any clogs

## 5.5 Rainwater Gardens

### *What is a rainwater garden?*

Rainwater gardens are landscaped depressions that collect and store storm water runoff allowing it to infiltrate, evaporate, and nourish plants. Rainwater gardens mitigate the environmental impacts of land development and provide attractive landscaping and habitat for many animals, including birds, butterflies, and insects. While rainwater may be used to irrigate any garden, rainwater gardens are intended to provide storage and; therefore, require sloped sides, berms, and hardy plants that can withstand periods of flooding as well as drought.



**Figure 5-3: Rainwater garden implemented in the front yard of a single-family Santa Barbara residence**

residential homes, front and back yards are good locations as long as the location will intercept runoff naturally or if runoff can be collected and routed with a diversion berm, natural conveyance channel, or landscape pipes.

### *What does it do? Or How does a rainwater garden work?*

Rainwater gardens collect and store runoff from downspouts and other sources and allow it to slowly seep into the ground rather than flow directly to a storm water conveyance system (storm drain inlets and drain pipes). The bottom of the garden is level to ensure uniformly distributed infiltration; however, the surface of the garden should be bowl shaped and should gently slope up to the ground level along the edges to minimize risk of erosion. A berm surrounding the garden contains water in the garden. Native hardy plants that can withstand flooding as well as drought provide an attractive landscape and wildlife habitat in addition to enhancing the infiltration capacity of the garden.

Rainwater gardens are not ponds and should not retain water for more than 48 hours after the rain stops. Depending on the infiltration capacity of the soils, it may be necessary to line the

### *How does a rainwater garden aid in storm water management?*

Rainwater gardens are a type of bioretention BMP that retain and infiltrate storm water runoff and reduce the rate, volume, and pollution carried by storm water. While the plants in the rainwater garden transpire water (uptake water from their roots) and utilize nutrients, the plants and the soil filter, uptake, and biodegrade pollutants. In addition, the infiltrating rainwater may recharge groundwater.

### *Where should rainwater gardens be used?*

Rainwater gardens may be used in a variety of locations, including new and existing developments. For



bottom of the garden with a layer of sand to promote infiltration while adding some storage capacity or amending the soil with sand, organic material, and/or top soil (see Section 5.10).

### ***How much does a rainwater garden cost?***

A rainwater garden costs between nothing (if you do all of the work yourself and do not have to purchase plants) and \$10-12 per square foot if you hire a landscaper (Bannerman & Considine, 2003).

### ***Components***

- Soil amendments
- Plants
- Conveyance channel (e.g., rock or vegetated concave path)

### ***Site Considerations***

1. Determine where the runoff to the garden will originate (e.g., which disconnected downspout) and determine the amount of the impervious area that will drain to the rainwater garden (See Section 5.2.3). If one side of the house drains to two downspouts, assume that half goes to each downspout.
  - a. The rain garden size can vary between 5% and 30% of the impervious area that drains to it depending on the soil type (i.e., if the soils are more clayey, infiltration will happen more slowly and more rainwater garden surface area will be required)
2. Identify slopes (natural drainageways), soil types, and infiltration capacity of existing soils (see design considerations below for soils), and if using a natural flowpath for conveyance to the garden ensure that the water will reach the garden (i.e., if flowpath has a high infiltration rate the rainwater may infiltrate in the flowpath before reaching the garden; you may wish to consider using alternative conveyance or moving the garden closer to the runoff source, at least 10 feet from house foundation).
3. Once a possible location has been identified, that location should be investigated to determine which type of soil is dominant as well as if the location and its tributary path have adequate drainage (See Section 5.2.1).

### ***Design Considerations***

1. Size and shape of the rainwater garden
  - a. Should not exceed 300 sq. ft. in area or should not be sized to capture runoff from more than 4,000 sq. ft. of impervious area; if the size exceeds one of these criteria, sizing should be based on calculations for bioretention areas (see Section 6.6.1)
  - b. Can vary between 5% and 30% of the impervious area that drains to it depending on soil type
  - c. Side slopes should be no steeper than three horizontal to one vertical (3H:1V)
  - d. Ponding depth should be shallow (maximum of 6 - 8 inches)

- e. Once the impervious area draining to the rainwater garden and the desired ponding depth are determined, utilize a sizing factor shown in Table 5-2 to calculate the area needed for the rainwater garden with the following formula:

$$\text{Size of rainwater garden} = \text{size factor} \times \text{drainage area}$$

**Table 5-2: Sizing factors for Rainwater gardens (modified from Bannerman, 2003)**

| Soil Type   | 6-7 in. deep | 8 in. deep |
|---|--------------|------------|
| <i>Rainwater gardens between 10 and 30 feet from downspouts</i> |              |            |
| Sandy   | 0.15         | 0.08       |
| Silty   | 0.25         | 0.16       |
| Clayey  | 0.32         | 0.2        |
| <i>Rainwater gardens more than 30 feet from downspouts</i>      |              |            |
| Sandy   | 0.03         |            |
| Silty   | 0.06         |            |
| Clayey  | 0.10         |            |

For example, use the area that drains to downspout A as calculated as 375 square feet in Section 5.2.3. To minimize the amount of area required for the garden, 8" of ponding depth was chosen. From the texture by feel test (see Section 5.2.1), it was determined that the soil was silty. Therefore, the sizing factor from Table 2-2 is 0.16.

**Size required for rainwater garden = 0.16 x 375 sq. ft. = 60 sq. ft.**

## 2. Location

- Full to partial sun
- At least ten feet from a building foundation
- Do not locate over shallow utilities (have utilities located before digging)
- Do not locate where the seasonally high groundwater table is within two feet of the bottom of the rainwater garden
- Site slope should be less than 15%
- Should not be located near (i.e., within 50 feet) of steep slopes (>25%)
- The area draining to garden should be stabilized prior to building the garden
- If pre-treatment is necessary, locate downstream of a vegetated filter strip (See Section 6.6.3)
- If flow spreading is desired prior to entering the garden, use a flow spreader or vegetated filter strip that directs runoff to the garden as shallow sheet flow instead of in a concentrated channel

### 3. *Soils*

- a. NRCS hydrologic soil groups "A" and "B" are appropriate for rainwater gardens (see maps in Appendix B for a general idea if you may be located in an area with these types of soils)
  - i. You may wish to use <http://websoilsurvey.nrcs.usda.gov/app/> to see a map of the soil survey based on your address
- b. Check to ensure that adequate infiltration is available by using the simple infiltration method (Tiers 1 and 2) or the more complete soil assessment (Tier 3); see Section 5.2.1 or Chapter 3, respectively
- c. Compaction should be avoided
- d. Soil amendments may be needed (see Section 5.10)

### 4. *Plants*

- a. Based on site conditions
- b. Use native species as often as possible (see Section 5.11 for planting guidance and Appendix G for a plant list appropriate for rainwater gardens)
  - i. Use species that can tolerate flooding as well as drought
- c. Use a variety of different plants (heights, colors, bloom times, etc.) to enhance the wildlife function of the garden
- d. Consider view to and from the street (you don't want plants that completely block the view)
- e. Tallest plants should go in the center or deepest area of the garden

### ***Maintenance considerations***

Quarterly maintenance activities:

1. Repair signs of erosion immediately
2. Inspect plants
3. Remove weeds, or more frequently as needed

Annual maintenance activities:

1. Test soil (see Section 5.2.1)
2. Inspect for excess sediment
3. Replace plants as needed
4. Prune as needed

Every two years maintenance activities:

1. Replace mulch

Infrequent maintenance activities:

1. Inspect for excess sedimentation periodically for the first 19 years and regularly after about 20 years; remove sediment when necessary

*For more information on sizing and installing rainwater gardens, see the following website:*

*Rain Gardens: A how-to-manual for homeowners:*

<http://clean-water.uwex.edu/pubs/pdf/home.rgmanual.pdf>

LID Center – Rain Garden Design Template

[http://www.lowimpactdevelopment.org/raingarden\\_design/](http://www.lowimpactdevelopment.org/raingarden_design/)

## 5.6 Rain Barrels

### *What is a rain barrel?*

Rain barrels are aboveground storage vessels that capture runoff from roof downspouts during rain events and store that runoff for later reuse for irrigating landscaped areas. However, rain barrels do not hold large volumes of water (typically less than 100 gallons), but may be connected in series. For larger applications, cisterns (large rain barrels) should be used. See Section 6.9.1 for more information on sizing cisterns.

### *How does a rain barrel aid in storm water management?*

Rain barrels detain (temporarily hold) roof runoff, reducing the runoff volume from a property and may reduce the peak runoff velocity for small, frequently occurring storms. In addition, by reducing the amount of storm water runoff that flows overland into a storm water conveyance system (storm drain inlets and drain pipes), less pollutants are picked up and transported through the conveyance system into local creeks and ocean. By infiltrating rainwater using irrigation or other infiltration process, groundwater is also being recharged. Furthermore, by storing rainwater for reuse for irrigation, potable water is conserved.



**Figure 5-4: Rain barrel blends into surroundings**

*Photo Credit: Illinois Public Works Department*

### *What applications are best for a rain barrel?*

Rain barrels are typically used in residential settings and located near existing downspouts.

### *What does it do? Or how does a rain barrel work?*

Rain barrels are located near existing roof downspouts so that the flows from the existing downspouts are diverted easily into the rain barrel. Rain barrels fill from the top (through a screen or grate to filter coarse sediment) and empty either by draining through the bottom of the tank by gravity flow or with the assistance of a pump through the top or bottom of the tank. Rain barrels may be operated either as a reservoir for temporary storage of runoff (emptied in between events), or as a flow control unit that temporarily stores and slowly releases runoff.

As a **reservoir**, the valve remains closed during storm events to collect runoff and must be emptied between storms and used for landscape irrigation or other non-potable water use so that the barrel is empty and ready to capture runoff from the next storm. As a **flow control unit**, the valve remains partially open and releases the water from the barrel at a slower rate

than the rate that it fills the barrel. In either case, an overflow must be provided for when the barrel is filled. Ideally, the overflow of water from the barrel will remain on-site and be dispersed into vegetated pervious areas using a splash block or other type of flow spreading method to allow for infiltration or be captured, stored, infiltrated, and/or treated in another type of BMP. Overflow should be conveyed away from the structure and neighboring structures. However, where infiltration is slow, and the existing downspout has a connection to the storm water conveyance system, it may be advised to connect the overflow directly into the storm water conveyance system.

### ***Where do I get a rain barrel?***

Rain barrels are available for purchase in a variety of shapes, sizes, and materials allowing for aesthetically pleasing incorporation into the site. New rain barrels can be purchased online, and local gardening and home supply/repair stores are beginning to stock their inventory with rain barrels.

### ***How much does a rain barrel cost?***

Prices for rain barrels range from \$60 to several hundred dollars, depending on style and capacity.

### ***Components***

1. Water tight container
2. Overflow mechanism
3. Screen to provide vector control, safety, and prevent clogging
4. Outlet spigot or hose
5. Inlet gutter or hose

### ***Design considerations***

1. Should be aesthetically incorporated into surroundings by:
  - a. Painting it the same color as the house so that it blends in,
  - b. Placing it under a raised deck or within a structure so it is hidden,
  - c. Surrounding it with vegetation and/or an aesthetically appealing structure such as a lattice screen, and/or
  - d. Using a rain barrel that fits the surrounding theme (e.g., an old wine barrel)
2. Should be designed to minimize clogging from leaves and other debris, prevent drowning, and provide vector control; inlet should be covered with a fine screen
3. If intending to use the collected water for a specific purpose you may desire to collect more water than can be stored in one barrel, if that is the case, barrels may be connected in series (i.e., overflow from one barrel connected as an inlet to the next)

*If you purchased your rain barrel with inlet and outlet included:*

1. Install barrel using the instructions that came with the barrel (if available). The following is only intended to provide general guidance:
  - a. The barrel should be installed and secured (to prevent it from falling over) on a foundation (concrete blocks work well). It will need to be high enough so that you can access the water (either with a hose or a bucket).
    - i. Rain barrels are often installed on a platform to allow some maneuverability for getting water from the outlet of rain barrel. Since the outlet is often near the bottom of the barrel to allow the water to drain out by gravity flow, raising the barrel off the ground allows insertion of containers such as water cans for ease of filling.
  - b. Caution should be taken to ensure that the barrel remains child safe. You do not want a child to be able to get into or tip over a barrel full of water.
  - c. Once the barrel is in place, you will be able to determine where the downspout will need to be cut. Using the new elbow that will be installed on the downspout (see Section 5.3), hold it near the barrel so that you can see how high up you will need to cut the downspout to install the new elbow allowing some space (approximately 1") between the bottom of the elbow and the top of the barrel/screen.
  - d. Using a hacksaw, cut the downspout, and attach the elbow or other device used to get runoff into the barrel.
  - e. Ensure overflow is connected to another barrel, back into the storm water conveyance system, or other pervious surface that will be used for infiltration
  - f. Test the rain barrel's operation
    - i. If using a hose attached to the outlet to remove water that collects in the barrel, the end of the hose must be lower than the level of the water in the barrel for the water to drain out of the barrel.

### ***Maintenance Considerations***

Periodic maintenance activities:

1. Remove debris that collects on inlet screen; if the debris includes roofing materials, place it in the trash; if the debris is mainly dirt and vegetation, place it in a green waste container.

Annual maintenance activities:

1. Clean barrel out; do NOT dump water in the barrel onto a driveway, sidewalk, or street; clean barrel out over lawn or other permeable area.

## 5.7 Contained Planters

### *What is a contained planter?*

Contained planters are containers that hold soil and plants, providing areas of pervious surface in otherwise impervious areas.

### *How do contained planters aid in storm water management?*

Contained planters decrease the imperviousness of an area (e.g., in tightly confined urban areas with little pervious area) by “covering” up the impervious area with pervious area and reduce the amount of runoff that occurs from impervious surfaces. Planters provide space for soil and plants that retain (except during large storms) storm water runoff rather than allowing it to flow directly to the storm water conveyance system (storm drain inlets and drain pipes) and then to local creeks and oceans. The retained storm water runoff is then evaporated or transpired (water taken up by plants) from the planter. In the event of a large storm, excess water from the planter may drain out the bottom or through a provided overflow structure.

### *What applications are best for contained planters?*

Contained planters are an excellent choice for implementing in an urban area that is impervious. They may be placed on impervious areas such as parking areas, rooftops, sidewalks, and patios.

### *How much does a contained planter cost?*

Planters are inexpensive and may be purchased at a variety of locations, including hardware, garden, and multi-purpose stores or built relatively easily.

### *Components*

- Contained planter
- Soil
- Plants

### *Design Considerations*

1. Plants should be hardy, native, tolerant of drought and flooding, and self-sustaining to minimize need for fertilizers and pesticides



**Figure 5-5: Contained planters with trees and flowers**

*Photo Credit: Geosyntec Consultants*



2. Depending on the size of the planter, plants may include trees, shrubs and/or ground cover (See Section 5.11 and Appendix G for ideas on which plants to use)
3. Depending on the types of plants chosen determine what type of soil should be used (See Section 5.10 for information on soil amendments)
4. Planters are widely available in a variety of shapes and sizes and may be created by recycling other containers
5. If you build a planter, or convert recycled items into planters:
  - a. Remember that holes should be drilled in the bottom to allow excess water to drain (you don't want to drown the plants)
  - b. It should not be made with treated wood that may leach toxic chemicals.
6. Planters may be permanently affixed (built-in) or separate units that may be moved around as desired.
7. Planters, depending on size and location, may need to have an overflow structure to accommodate larger flows that may drown the plants if not diverted

### ***Maintenance considerations***

Occasional maintenance activities:

1. Fertilizer may be needed, in which case it should be a slow acting organic fertilizer that will not contaminate the runoff from the planter with nutrients.
2. Soil should be tilled to improve infiltration.

## 5.8 Depression Storage

### *What is depression storage?*

Depression storage is the use of depressions, either artificial or natural, on a site for storing storm water runoff to allow it to soak in. This method is similar to rainwater gardens, in that it must be vegetated and its purpose is to promote infiltration; however, its vegetation should be grass or some other dense groundcover, rather than a combination of trees, shrubs, and groundcovers.



**Figure 5-6: Depression Storage**

*Photo Credit: New Zealand Water Environment Research Foundation*

storm water runoff to allow it to soak in. This method is similar to rainwater gardens, in that it must be vegetated and its purpose is to promote infiltration; however, its vegetation should be grass or some other dense groundcover, rather than a combination of trees, shrubs, and groundcovers.

### *How does depression storage aid in storm water management?*

Depression storage promotes infiltration and reduces runoff volumes and rates as well as

pollution. Depression storage contains storm water runoff by providing an area on the surface for water to build up or accumulate during a storm and slowly soak into the ground.

### *What applications are best for depression storage?*

Existing natural depressions, provided that they are adequately maintained, is a primary source of depression storage in yards. In addition, they may be created by grading the site.

### *How do I create/maintain depression storage?*

Large depression storage may be created by grading your lawn so that the center is just a few inches shallower than the edges of the lawn. Small depression storages are created the same way, but are shallower and confined to a smaller area. Small depressions on slopes may drain into one another, assuming that conveyance in between is stabilized sufficiently to prevent erosion.

### *Design Considerations*

1. Determine if soils are infiltrative enough for depression storage:
  - a. Check to ensure that adequate infiltration is available by using the simple infiltration method for Tier 1 and Tier 2 projects or the more complete soil assessment for Tier 3 projects. See Section 5.2.1 or Chapter 3, respectively, for more information on conducting these tests.

2. Depression storage should be created by excavation of native soil rather than built up like a berm.
3. Ponding depth should be shallow (maximum of 6 - 8 inches)
4. Compaction should be avoided.
5. Should be designed to provide vector control
6. Side slopes should be no steeper than three horizontal to one vertical.
7. Multiple depressions should be separated by a minimum of four feet.
8. Depression overflow point should be located such that it does not cause erosion or inadvertent inundation.
9. Location
  - a. At least ten feet from a building foundation
  - b. Do not locate over shallow utilities (have utilities located)
  - c. Do not locate where the seasonally high groundwater table is within two feet of the bottom of the depression
  - d. Site slope should be less than 15%
  - e. Should not be located near (i.e., within 50 feet) of steep slopes (>25%)
  - f. If flow spreading is desired prior to entering the depression, use a flow spreader or vegetated filter strip that directs runoff to the depression as shallow sheet flow instead of in a concentrated channel

### ***Maintenance considerations***

Depression storage features should be as easy to maintain as your current lawn, they should only require mowing of the grass and repair of erosion if evident. If dense, native groundcovers are used in place of turf grass, then they may not require mowing but may require some trimming.

## 5.9 Permeable Pavement for Single-Family Residences

### *What is permeable pavement?*

Permeable pavements contain small voids (holes) in the pavement that allow water to pass through to an underground stone reservoir (open-graded base) where runoff accumulates and is stored while it either infiltrates into the soil (soil subgrade) or is slowly released to a storm water conveyance system (storm drain inlets and drain pipe) or to another type of BMP.

### *How does permeable pavement aid in storm water management?*

Permeable pavements help decrease storm water runoff volume, reduce storm water runoff velocities, and improve water quality by filtering storm water through the stone reservoir, and when soil infiltration rates allow, by allowing it to filter through the soil beneath the stone reservoir.

### *What applications are best for permeable pavement?*

Permeable pavements come in a variety of forms; they may be a pour in place type system (porous concrete, permeable asphalt) or a modular paving type system (concrete pavers, grass-pave, or gravel-pave). Modular paving systems are most appropriate for single-family residences (Tier 1 and Tier 2 projects).



**Figure 5-8: Permeable pavers in a driveway in front of a single-family residence in Santa Barbara.**

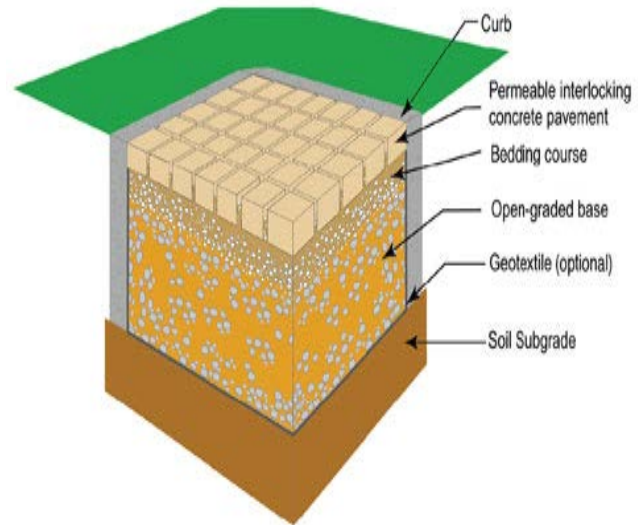

**Figure 5-7: Typical permeable pavement cross-section**

*Diagram Credit: Interlocking Concrete Pavement Institution*

### *Concrete Pavers*

For single-family residences, concrete paver can be used in place of impervious concrete or asphalt surfaces in such places as driveways, parking areas, patios, and walkways.

*Grass-Pave*

**Figure 5-9: Grass paver blocks in a residential driveway**

*Photo Credit: Roger Bannerman*

For single-family residences, grass-pave is most applicable for driveways and parking areas providing support for the weight of vehicles but allowing the driveway to be mainly grassed and pervious.

*Gravel-Pave*

For single-family residences, gravel-pave can be used for driveways, parking areas, and walkways with some restrictions. The gravel-pave must be at least 200 feet from the street for driveways and parking areas, which prevents gravel from being displaced from vehicles onto streets. If the driveway or parking area is to be used for fire access, approval must be provided from the fire department. Gravel-pave should not be placed on walkways that are required to handicap accessible.



**Figure 5-10: Gravelpave<sup>2</sup>**

*Photo Credit: Gravelpave<sup>2</sup>*

***How do I create/maintain permeable pavement?***

For more information on sizing, designing, and construction of permeable pavement, see Section 6.8.

## 5.10 Soil Amendments



**Figure 5-11: Soil amended area at U.S. EPA Ariel Rios Building**

*Photo Credit: Low Impact Development Center*

### *What are soil amendments?*

A soil amendment is anything that is added or done (e.g., aeration) to the soil to alter its physical, chemical, and biological characteristics. Compost and fertilizers are common soil amendments that must be completely mixed into the soil to function properly.

### *How do soil amendments aid in storm water management?*

Soil amendments alter the soil characteristics to allow it to reduce runoff volume and velocity, filter pollutants, increase the quality and quantity of vegetation, and reduce erosion potential more effectively than soils without soil

amendments. Mulch is an amendment that is added on the top of the soil, rather than mixed into the soil, which reduces evaporation and adds to the aesthetics of a site.

### *How much do soil amendments cost, how are they applied and why?*

Table 5-3 below outlines different soil amendments, the depth of the amendment, how it is used, and how it improves the soil.

**Table 5-3: Soil Amendments and their specifications**

| <b>Item</b>                             | <b>Depth</b>   | <b>Cost<br/>(2008 dollars)</b> | <b>Specifications</b>                            | <b>Purpose</b>   |
|---|--|--------------------------------|--|--|
| Soil Clearing and Testing               | 6" – 12"   | \$3 - \$5/sq. yd.              | Clearing and grubbing; soil infiltration testing | Evaluate soil compaction and organic nutrient content/requirements                     |
| Nitrolized Redwood Shavings             | 6" – 12" (i.e., depth to which the shavings should be mixed in)                      | \$95/cu. yd.                   | Roto-till shavings into native soil              | Increase infiltration rates and water retention properties of soil                     |
| Compost/ Soil Conditioners/ Fertilizers | 6" – 12" (i.e., depth to which the compost, soil, or fertilizers should be mixed in) | \$95/cu. yd.                   | Roto-till into native soil                       | Increases infiltration rates, water retention properties, and nutrient content of soil |

| Item       | Depth    | Cost<br>(2008 dollars) | Specifications  | Purpose   |
|------------|----------|------------------------|---|---|
| Bark Mulch | At Grade | \$10-\$30/cu.<br>yd.   | Spread over all<br>planting areas to<br>a depth of 3" | Reduces evaporation<br>and increases water<br>retention properties<br>of soil |

#### ***Where should soil amendments be added?***

Soil amendments can improve the properties of almost any soil and should be incorporated where existing soil is in poor condition (e.g., lack of nutrients, minimal infiltration, etc.). Amendments may also be added where they may increase the effectiveness of a BMP, or to alter conditions in order to accommodate the implementation of a BMP. Soil amendments are common components of several infiltration BMPs, including rainwater gardens, depression storage, bioretention, vegetated swales and filter strips, infiltration basins, planter boxes, green roofs, dry extended detention basins, wet retention basins, constructed treatment wetlands, and general landscaping. Soil amendments should not be applied in naturally wooded areas or on slopes steeper than 15%.

#### ***Maintenance considerations***

*Care should be taken when adding fertilizers; more is not necessarily better. Applying fertilizers in excess may be washed off and contaminate storm water.*

Annual maintenance activities:

1. Inspect soils for signs of compaction, waterlogged areas and diseased vegetation (may be a sign of too much water).
2. Test soils to determine infiltration condition of soils and what amendments may be needed (see Section 5.2.1).
3. Re-aerate, till or add additional amendments to the soil if infiltration rates have decreased noticeably or there are signs of compaction.

## 5.11 Ribbon Driveways

### *What is a ribbon driveway?*

Ribbon driveways are constructed of two parallel strips of pavement for automobile wheels, with a pervious surface (e.g., gravel, grass, or other low growing vegetation) in between. Other names for ribbon driveways are “hollywood” driveways, paving-under-wheels driveways, and strip driveways.

### *How do ribbon driveways aid in storm water management?*

Ribbon driveways decrease the amount of impervious surface by limiting the pavement area to narrow driving strips. Ribbon driveways increase the amount of pervious area and disconnect impervious surfaces by allowing the runoff from the driving strips to drain to landscaping. Ribbon driveways decrease the amount of runoff entering the storm water conveyance system and reduce pollution carried by storm water. In contrast, conventional driveways that directly connect roof runoff to the storm water conveyance system increase the rate and volume of runoff by not providing opportunity for runoff to be slowed, infiltrated, or treated. Depending on whether the storm water conveyance system is connected with the sanitary sewer (meaning both flow together in the same pipe), storm water can either exit the conveyance system into a stream, ditch, or the ocean or it can flow to a wastewater treatment plant. The high velocity, volume, and pollutants exiting the conveyance system into streams and ditches can have a significant environmental impact by eroding stream channels and harming aquatic life.



**Figure 5-12: Ribbon Driveway**

*Photo Credit: Good Home Construction, CA*



**Figure 5-13: Ribbon Driveway**

*Photo Credit: Fullerton Heritage, CA*

### *What applications are best for ribbon driveways?*

Ribbon driveways are an excellent choice for implementing in residential driveways that may be short and straight (making it easier to pave the strips). They may replace existing driveways as well as be used in locations that currently do not have a paved driveway, but require a more substantial driving surface.

### *Design Considerations*

Ribbon driveways often consist of two 2-foot strips of concrete pavement with a permeable strip in between. The center strip can be left open to be planted with grass or groundcover, or filled with a permeable material such as gravel. Ribbon driveways are cheaper to install than conventional driveways.



***Maintenance considerations***

Occasional maintenance activities:

3. Grass and/or low-lying vegetation should be mowed to allow clearance for vehicles.
4. Fertilizer may be needed for vegetation, in which case it should be a slow acting organic fertilizer that will not contaminate runoff with nutrients.
5. Soil within the center strip can be tilled to improve infiltration.

## 5.12 Landscaping Considerations

### *What are landscaping considerations?*

Revegetating or landscaping a site using trees, shrubs, grasses, or other groundcover provides an opportunity to reintroduce native vegetation, which may be more disease-resistant and require less maintenance than non-native species. Benefits of native landscaping include:

- erosion control/soil stabilization
- runoff volume reduction
- water quality treatment (especially for sediment and nutrients)
- habitat creation
- aesthetic enhancements
- creation of, or addition to, local greenways and wildlife corridors
- reduction of water demands for landscaping

The landscaping considerations apply to general site landscaping, restoration, as well as vegetated Basic BMP and Storm Water Runoff BMP options.



**Figure 5-14: Local landscaping**

### *How does landscaping aid in storm water management?*

Planting trees, shrubs, grasses, or groundcover in as many areas as possible will reduce the runoff volume, velocity, and pollutants leaving a site by increasing the site's infiltration, storage, and filtering capacity. Depending on the infiltration capacity of the soil, runoff (e.g., from disconnected downspouts) can be routed to a vegetated pervious area or a vegetated BMP to reduce runoff volume, velocity, and pollutant loadings (i.e., pollutant loading is calculated by multiplying the runoff volume by the pollutant concentration; for example, a volume of 100 liters of runoff is multiplied by a concentration of 10 mg/liter of nitrate which equals 1,000 mg of nitrate load). Connecting landscaped areas and vegetated BMPs in a "treatment train" across the site can have a more appreciable effect on reducing runoff volume and velocity than small individual landscape plantings surrounded by impervious surfaces.

Volume reductions will also result from rainfall interception by leaves and increased evapotranspiration (ET) or uptake of rainfall/runoff by plants. Interception and ET will have a greater effect on runoff volume reduction for small, frequently occurring, low intensity storm events.

In addition to plant selection and landscape design, soil preparation is also a critical factor in determining runoff retention on a site. Soil conditions favorable to plant growth generally also provide the greatest runoff volume reduction. Soils must be loose enough to allow water to infiltrate and roots to penetrate. Soil amendments can be used to increase infiltration (see Section 5.11).

***How much does landscaping cost?***

Table 5-4 outlines different sizes and types of plants that may be used for landscaping as well as the associated costs (i.e., cost per plant and installed costs).

**Table 5-4: Landscaping plants and associated local costs**

| Item                  | Unit    | Unit Price    | Estimated Installed Cost* |
|-----------------------|---------|---------------|---------------------------|
| Tree (24" box size)   | Ea      | \$165 - \$210 | \$300.00 - \$350.00       |
| Tree (15 gallon size) | Ea      | \$45 - \$60   | \$75.00 - \$100.00        |
| Shrub (5 gallon)      | Ea      | \$14 - \$16   | \$25.00 - \$30.00         |
| Shrub (1 gallon)      | Ea      | \$3 - \$5     | \$6.00 - \$10.00          |
| Grass (2" cell)       | Ea      | \$.50 - \$1   | \$2.00 - \$3.00           |
| Seed                  | Sq. ft. | \$.05 - \$.15 | \$.25 - \$.30             |

\* Indicates in-place cost when installed by a contractor

***Where should landscaping be located?***

Landscaping, in combination with soil amendments, should be located throughout the site to promote infiltration of storm water runoff. By carefully designing the landscape, you may enhance the infiltration capacity of a site. Increased amounts of vegetation enhance the infiltration rate of soils by utilizing the water themselves and creating larger pore spaces in the soil around the vegetation roots. Landscaping may be planned to incorporate a variety of plants that may benefit the hydrology and ecology of the site through general landscaping, restoration, and incorporation of vegetative BMPs. Contained planters should be located on impervious surfaces to reduce the imperviousness of the site and provide additional pervious area. Bare earth areas should also be landscaped and amended with soils to enhance the pervious areas infiltration capacity. Landscaping techniques may be used to incorporate channels for directing runoff away from foundations and to pervious areas or other basic and/or storm water runoff BMPs, while minimizing erosion. Many of the basic and storm water runoff BMPs in this chapter and in Chapter 6 require the use of landscaping for proper implementation. See each of the individual sections for more specifics regarding the types of landscaping required.

***What type of plants should be used for different purposes?***

Landscaping provides aesthetics as well as improving infiltration capacity. Plants should be selected for each location based on the purpose they will serve. Landscaping has a large effect on the effectiveness of many BMPs discussed in this Manual. For example, you need to use plants that are tolerant of flooding and drought for rainwater gardens and bioretention areas; requirements that do not need to be met for ordinary landscaping intended for aesthetics and enhancement of infiltration capacity in already pervious areas. See Appendix G for native plant selections that are separated into sections based on BMP type. The plant recommendations in Appendix G are provided as general guidelines only and do not replace the design guidance of a landscape professional.

***Design considerations***

Landscaping should be chosen carefully based on its intended purpose. In high fire hazard areas, areas prone to erosion, and other sensitive areas, refer to the City's Architectural Review Board Document Section 2: Landscaping Guidelines. For any landscaping alterations greater than 5000 square feet, or that require extensive grading, revegetation, or improvements with unique sensitive habitats or environments, a licensed landscape professional must prepare the landscape plan.

***Maintenance considerations***

Different landscaping techniques will require different amounts and types of maintenance. While some plants need regular attention (e.g., pruning, addition of soil amendments, on-going periodic irrigation, etc.), others, especially native plants, require regular maintenance (e.g., weeding and irrigation) during establishment then require minimal pruning and irrigation. However, others may need annual pruning. Select plants based on amount of maintenance required. In addition, rock or vegetated channels may be used in landscaping for channeling water away from foundations and into BMPs. These types of conveyance channels need to be inspected for signs of erosion and repaired as needed.

A general schedule of maintenance activities is provided below:

## Monthly:

1. Remove weeds

## First year:

1. Water as needed, especially during times without rain

## Annually:

1. Address erosion, if necessary
2. Replace dead plants
3. Prune plants, as appropriate for each plant

## Every 2-3 years:

1. Reapply mulch

**For more information regarding landscaping requirements in the City, refer to the City's Landscaping Guidelines:**

Architectural Board of Review General Design Guidelines & Meeting Procedures  
<http://www.santabarbaraca.gov/civicax/filebank/blobdload.aspx?BlobID=17281>

Landscape Design Standards for Water Conservation  
<http://www.santabarbaraca.gov/civicax/filebank/blobdload.aspx?BlobID=34124>

Landscape Compliance Requirements  
<http://www.santabarbaraca.gov/civicax/filebank/blobdload.aspx?BlobID=34125>

List of Plant Materials Recommended for El Pueblo Viejo  
<http://www.santabarbaraca.gov/civicax/filebank/blobdload.aspx?BlobID=17291>

## 6 STORM WATER RUNOFF BMP OPTIONS

### 6.1 General Considerations

The storm water runoff BMP options provided in this chapter are intended to assist Tier 3 new development and redevelopment projects in meeting the storm water runoff requirements of the City of Santa Barbara's Post-Construction Storm Water Management Program. Tier 3 projects are defined in the project thresholds table (Table 1-1) and requirements for project approval are outlined in Section 1.3.3. The *storm water runoff requirements* are outlined below in Section 6.2 and in Appendix C.

Tier 3 project applicants must demonstrate an integrated approach to meeting the storm water runoff requirements by implementing a combination of site design BMPs (Chapter 4), basic BMPs (Chapter 5), and storm water runoff BMPs (this Chapter) that utilize a site's inherent natural hydrologic features to reduce the generation of runoff and to de-centralize runoff BMPs to handle the runoff generated. The site design BMPs described in Chapter 4 assist by reducing the volume of site runoff and maintaining pre-development time of concentration ( $T_c$ ) to the maximum extent practicable by using natural, non-structural methods. The basic BMPs in Chapter 5 provide basic options for continuing to reduce the volume of site runoff and maintaining pre-development  $T_c$ . Some of the basic BMPs in Chapter 5 are intended specifically for single-family residential use, specifically rain gardens and rain barrels. The other BMPs in Chapter 5 are applicable to larger Tier 3 sites although explicit credit towards meeting the storm water runoff requirements is not provided for these BMPs (see Table 5-1 for more detail). By reducing the site's volume of runoff and  $T_c$  to the maximum extent practicable using site design and basic BMPs, there is an implicit reduction in the storm water runoff requirements by reducing a site's generation of runoff volume, flow rate, and pollutants of concern.

Tier 3 projects must use the storm water runoff BMPs in this Chapter to meet the storm water runoff requirements of the City. Tier 3 projects must also select BMPs that target identified pollutants of concern based on the project site's land use and must also select BMPs that target pollutants identified in the 2006 Clean Water Act 303(d) List of Water Quality Limited Segments if the project contributes to one or more of the impaired receiving waters within the City. Section 6.3 discusses the BMP selection process for Tier 3 projects. The City encourages applicants to integrate and distribute several storm water runoff BMP options across the site and to maximize vegetative cover and infiltration to the maximum extent practicable. For some Tier 3 single-family residential projects, an architect or other design professional may produce the analysis, dependent on City staff approval.

### 6.2 Storm Water Runoff Requirements for BMP Sizing

The City of Santa Barbara developed storm water runoff requirements for Tier 3 ("large") projects in order to meet or exceed the requirements of the NPDES Phase II State General Permit for the Discharge of Storm water from small MS4s (CAS000004). These requirements were incorporated into the City's Storm Water Management Plan (SWMP), approved by the Water Board in 2009, and include; (1) a peak runoff discharge requirement, (2) a volume reduction requirement, (3) and a water quality treatment requirement.

The City of Santa Barbara has implemented a peak runoff discharge rate requirement, a volume reduction requirement, and a treatment requirement. The following sections describe the requirements for which storm water runoff BMPs shall be sized. Methods for calculating the site-specific storm water runoff requirements are provided in Appendix C. Methods for sizing each of the storm water runoff BMPs are provided in the individual BMP sections of this chapter. An equivalent sizing approach to those provided in the individual BMP sections is acceptable as long as the applicant can demonstrate equal or greater runoff capture. For redevelopment projects, the net change in peak flow rates and volumes are to be compared with the predeveloped condition. Also for redevelopment projects, if a reduction in impervious surfaces (footprint) is proposed, then the Peak Runoff Discharge Rate and Volume Reduction Requirements do not apply.

### ***6.2.1 Peak Runoff Discharge Rate Requirement***

As required by the State General Permit, Santa Barbara County Flood Control District for the South Coast Region, and the City of Santa Barbara's SWMP, storm water runoff BMPs shall provide detention such that the post-development peak storm water runoff discharge rate shall not exceed the pre-development rate for the 2-, 5-, 10-, and 25-year 24-hour storm events. The method for calculating the peak storm water runoff discharge rate is described in Appendix C. For redevelopment projects, the net change in peak flow rates are to be compared with the predevelopment condition. If a project is subject to maintaining or reducing peak runoff discharge rates, the entire project site will be used to determine both the pre-development and post-development runoff discharge rate.

### ***6.2.2 Volume Reduction Requirement***

Retain on-site the larger of the following two volumes from the entire project site:

- The volume difference between the pre- and post-conditions for the 25-year, 24-hour design storm (for redevelopment, the pre-condition is the predevelopment condition).
- The volume difference between the pre- and post-conditions generated from a one-inch, 24-hr storm event

Methods for calculating volume reduction for both options are provided in Appendix C.

### 6.2.3 Water Quality Treatment Requirements

Water quality treatment requirements are differentiated based on whether the BMP is volume-based or flow-based. The criteria for both are as follows:

- Volume-based storm water runoff BMPs (e.g., bioretention areas) shall be sized for the one-inch 24-hr design storm from the entire project site (not just the new or redeveloped area).
- Flow-based storm water runoff BMPs (e.g., vegetated swale filters) shall be sized based on a constant rainfall intensity of 0.25 in/hr for 4 hours from the entire project site (not just the new or redeveloped area).

Methods for calculating the volume- and flow-based water quality treatment requirements are provided in Appendix C. The City's Storm Water Permit and this Manual demonstrate a preference for using infiltration designs to capture and treat storm water. However, infiltration is not the only solution for meeting the City's storm water requirements; the alternatives where infiltration is not recommended include flow-through treatment designs (such as planter boxes and/or vegetated swales with under drains) as well as rain barrels, cisterns, and tanks for containment and later use for landscaping irrigation. For sites where soil conditions limit feasibility of complying with requirements, flow-based BMPs will likely be more practical than for sites with infiltrative soils. Volume-based BMPs will require underdrains for most of these sites.

### 6.2.4 Meeting Storm Water Runoff Requirements Simultaneously

It shall be noted that the volume reduction requirement and water quality treatment requirement are not additive and may be met simultaneously in many cases. Meeting the volume reduction requirement also meets the water quality treatment requirement if the volume reduction requirement is larger than the water quality treatment requirement. If the water quality treatment requirement is larger than the volume reduction requirement, only the difference in the volumes is required to be treated beyond that already treated by meeting the volume reduction requirement. Storm water runoff BMPs that allow for infiltration shall be sized using a design volume,  $V_{\text{design}}$ , which is the larger of the volume reduction and water quality treatment requirements. Storm water runoff BMPs that do not allow for infiltration will only receive credit towards meeting the water quality treatment requirement and, when applicable, the peak discharge requirement. In these cases, other storm water runoff BMPs would then be needed for meeting the volume reduction requirements. See Section 6.5 for suggested strategies for meeting the storm water runoff requirements.

## 6.3 BMP Selection Process

1. To select a storm water runoff BMP, each Tier 3 project shall compare the list of pollutants anticipated to be generated by the project land use (as identified in Table 2-2) with the pollutants for which the downstream receiving waters are impaired, if any (as defined in Table 2-3).

Any pollutants identified by Table 2-2, which are also causing a Clean Water Act section 303(d) impairment of receiving waters of the project as identified in Table 2-3, shall be considered *primary* pollutants of concern. Tier 3 projects shall select a single or

combination of storm water runoff BMPs, which address the particular *primary* pollutant(s) of concern and suitability based on site conditions. The BMP selection matrices (Table 6-1 and Table 6-2) shall be used as a guide to assist in the selection of BMPs. **BMPs shall be selected that have high or very high treatment effectiveness for the primary pollutants of concern.** The selected storm water runoff BMPs will address other pollutants in addition to the primary pollutant(s) as shown in Table 6-1.

2. Tier 3 projects that are not anticipated to generate *primary* pollutants of concern, shall select a single or combination of storm water runoff BMPs based on pollutants of concern anticipated to be generated by the project land use (as identified in Table 2-2) as well as the BMP selection matrices (Table 6-1 and Table 6-2). The selected BMP(s) shall be suitable for the site conditions and be designed to be effective in reducing pollutants of concern as outlined in Section 1.2.1.
3. Alternative storm water runoff BMPs not identified in the BMP selection matrices (Table 6-1 and Table 6-2) may be approved at the discretion of the City, provided the alternative storm water runoff BMP meets the storm water runoff requirements and can prove through documented BMP performance data that it is as or more effective in removal of applicable pollutants of concern as other feasible BMPs listed in the BMP selection matrices.

#### **6.4 Waivers for Storm Water Runoff BMP Requirements**

The City may allow for one or more of the storm water runoff requirements to be waived for a Tier 3 project if technical or legal infeasibility can be established by the project applicant. The City shall only grant a waiver of infeasibility when all available storm water runoff BMPs have been considered and rejected as infeasible. The burden of proof is on the project applicant to demonstrate that all available measures are infeasible. Where strict compliance with the City's storm water runoff requirements is found to be infeasible, the project applicant must utilize all feasible measures to achieve the greatest compliance possible.



**Table 6-1: BMP Selection Matrix - Pollutants of Concern**

*Important Note to Users:* Treatment effectiveness for pollutants of concern can vary widely for individual BMPs. This table should be used to provide general BMP comparisons only and should not replace the evaluation performed by a water quality professional. For greater accuracy, only compare treatment effectiveness within each of the Stormwater Runoff BMP Categories. BMPs shall be selected that have high or very high treatment effectiveness for the primary pollutants of concern as defined in Section 6.3.

| Manual Section | Stormwater Runoff BMP Category    | Stormwater Runoff BMP   | Volume Mitigation (% of inflow)  | Treatment Effectiveness for Pollutants of Concern <sup>1</sup>  |           |          |  |          |  |
|----------------|-----------------------------------|---|--|---|-----------|----------|--|----------|--|
|                |                                   |   |  | Trash   | Nutrients | Bacteria | Metals (particulate and dissolved fractions) | Sediment | Organics (hydrocarbons, oil, and grease) |
| 6.6            | Biofiltration and Filtration BMPs | Bioretention  |  |   |           |          |  |          |  |
|                |                                   | Vegetated Swale Filter  |  |   |           |          |  |          |  |
|                |                                   | Vegetated Filter Strip  |  |   |           |          |  |          |  |
|                |                                   | Sand Filter   |  |   |           |          |  |          |  |
| 6.7            | Infiltration BMPs                 | Includes infiltration trenches, infiltration basins, and dry wells                        |  |   |           |          |  |          |  |
| 6.8            | Permeable Pavement BMPs           | Includes pervious concrete, porous asphalt, permeable pavers, grass-pave, and gravel-pave |  |   |           |          |  |          |  |
| 6.9            | Building BMPs                     | Cistern/Rain Barrel   |  | Building BMPs are generally intended for achieving volume reduction of roof drainage. Treatment effectiveness of building BMPs are not comparable to other BMPs in this table that treat runoff from a wide range of impervious surfaces that generally have higher pollutant concentrations. |           |          |  |          |  |
|                |                                   | Planter Box   |  |   |           |          |  |          |  |
|                |                                   | Green Roof  |  |   |           |          |  |          |  |
| 6.10           | Retention and Detention BMPs      | Constructed Treatment Wetland   |  |   |           |          |  |          |  |
|                |                                   | Wet Retention Basin   |  |   |           |          |  |          |  |
|                |                                   | Dry Extended Detention Basin  |  |   |           |          |  |          |  |
| 6.11           | Proprietary Devices               | Includes hydrodynamic devices, catch basins, media filters, and biotreatment devices      | <i>The treatment effectiveness of specific proprietary devices must be provided by the manufacturer and should be verified by independent third-party sources and data or assessed by a professional consultant.</i> |   |           |          |  |          |  |

|           |      |          |     |          |
|-----------|------|----------|-----|----------|
| Very High | High | Moderate | Low | Very Low |
|           |      |          |     |          |

<sup>1</sup>Effectiveness may change based on design variations; standard BMP designs have been assumed.

**Table 6-2: BMP Selection Matrix - Site Suitability**

*Important Note to Users:* Site suitability can vary widely for individual BMPs. This table should be used to provide general BMP comparisons only and should not replace the evaluation performed by a professional consultant. For greater accuracy, only compare site suitability considerations within each of the Treatment BMP Categories.

| Report Section | Treatment BMP Category           | Treatment BMP   | Site Suitability Considerations   |   |   |  |   | Applicability for Special Design Districts   |   |
|----------------|----------------------------------|---|---|---|---|--|---|--|---|
|                |                                  |   | Drainage Area (Acres) <sup>1</sup>  | Site Slope (%)  | Depth to Seasonally High Groundwater (ft)     | Hydrologic Soil Group  | Horizontal Setback from Drinking Water Wells (ft) | Coastal Bluff Areas  | Hillside Design District  |
| 6.5            | Biofiltration BMPs               | Bioretention  | < 2   | < 15; planter boxes are generally more suitable for steep slopes <sup>2,3</sup> | > 2 with underdrains; > 5 without underdrains | Underdrains may be provided for "C" and "D" soils                            | 100 <sup>6</sup>                                  | Acceptable if underdrains are included and if the site slope meets the criteria provided in this matrix table. | Acceptable if site slope meets the criteria of this matrix table. If site slopes exceed 7%, underdrains should be included regardless of the hydrologic soil group condition of the site. |
|                |                                  | Vegetated Swale Filter  | < 5   | < 10 site slope; 1.5 to 6 longitudinal slope of swale <sup>2,3</sup>            | > 2 with underdrains; > 5 without underdrains | Any  | 100 <sup>6</sup>                                  |  |   |
|                |                                  | Vegetated Strip Filter  | < 2   | < 5 site slope; 2 to 15 longitudinal slope of strip                             | > 2   | Any  | N/A   |  |   |
| 6.6            | Infiltration and Filtration BMPs | Infiltration Trench & Basin   | < 5   | < 7 <sup>2</sup>  | > 5   | May not be feasible in "C" soils. Not suitable in "D" soils.                 | 100   | Infiltration BMPs not permissible in Coastal Bluff Areas.  | Acceptable if a geotechnical investigation proves that the facility does not compromise the stability of the site slope or surrounding slopes.  |
|                |                                  | Dry Well  | < 5   | < 7 <sup>2</sup>  | > 5   | May not be feasible in "C" soils. Not suitable in "D" soils.                 | 100   |  |   |
|                |                                  | Sand Filter   | < 10  | < 15 <sup>4</sup>   | > 2 with underdrains                          | Any  | N/A   |  |   |
| 6.7            | Permeable Pavement BMPs          | Includes pervious concrete and asphalt concrete (AC), permeable pavers, subsurface reservoir beds, and granular materials | Drainage Area is equal to area of pervious pavement   | < 5 <sup>2,5</sup>  | > 2 with underdrains; > 5 without underdrains | Underdrains may be provided for "C" and "D" soils                            | 100 <sup>6</sup>                                  | Acceptable if underdrains are included and if the site slope meets the criteria provided in this matrix table. | Acceptable if site slope meets the criteria of this matrix table. If site slopes exceed 7%, underdrains should be included regardless of the hydrologic soil group condition of the site. |
| 6.8            | Building BMPs                    | Cistern/Rain Barrel   | Depends on system size  | Any   | > 2 if tank is underground                    | Any  | N/A   | Acceptable if criteria for site slope is met.  |   |
|                |                                  | Planter Box   | Equal to roof drainage area   | < 15 <sup>4,5</sup>   | > 2 with underdrains; > 5 without underdrains | Underdrains may be provided for "C" and "D" soils                            | 100 <sup>6</sup>                                  |  |   |
|                |                                  | Vegetated Roof  | Equal to roof drainage area   | N/A   | N/A   | N/A  | N/A   |  |   |
| 6.9            | Retention and Detention BMPs     | Constructed Treatment Wetland   | > 10  | < 8 <sup>2</sup>  | > 2   | "A" soils may require pond liner; "B" soils may require infiltration testing | N/A   | Acceptable if criteria for site slope is met.  |   |
|                |                                  | Wet Retention Basin   | > 10  | < 15 <sup>2</sup>   | > 2   | "A" soils may require pond liner; "B" soils may require infiltration testing | N/A   |  |   |
|                |                                  | Dry Extended Detention Basin  | > 10  | < 15 <sup>2</sup>   | > 2   | Any  | N/A   |  |   |
| 6.10           | Proprietary Devices              | Includes hydrodynamic devices, media filters, and biotreatment devices  | <i>The site suitability requirements for specific proprietary devices must be provided by the manufacturer and should be verified by independent third-party sources and data or assessed by a professional consultant.</i> |   |   |  |   |  |   |

<sup>1</sup> Drainage areas should be used as a general guideline only. Drainage areas can be larger or smaller in some instances.

<sup>2</sup> If slope exceeds given limit or is within 200 feet from the top of a hazardous slope or landslide area, a geotechnical investigation is required.

<sup>3</sup> If system is located within 50 feet of a sensitive steep slope on the uphill side or 10 feet from a structure, underdrains should be incorporated.

<sup>4</sup> If system is fully contained and includes a liner, underdrain system, and overflow to a storm drain system, then slopes can exceed 15%.

<sup>5</sup> If a gravel base is used for storage of runoff: (1) slopes should be restricted to 0.5% (steeper grades reduce storage capacity) and (2) underdrains should be used if within 50 feet of a sensitive steep slope.

<sup>6</sup> Setbacks apply to systems without underdrains or systems underlain by "A" or "B" hydrologic soil groups.

## 6.5 Suggested Strategies for Meeting the Storm Water Runoff Requirements

The storm water runoff requirements can be met simultaneously through the use of “treatment trains” (multiple BMPs in series) or by modifying traditional detention and/or water quality treatment BMPs to meet more than one storm water runoff requirement. It shall be noted that the volume reduction requirement may be reduced or not required for sites where infiltration of the volume reduction requirement is infeasible. The following guidance provides potential strategies for utilizing treatment trains and for modifying traditional detention and/or water quality treatment BMPs to meet the storm water runoff requirements. Note that the following guidance provides potential strategies and is not an exhaustive list. How the storm water runoff requirements are met for a project is at the discretion of the designer and City reviewers.

- All or part of the three storm water runoff requirements can be achieved by first routing runoff from impervious areas to biofiltration BMPs incorporated into pervious, landscaped areas of the site. Runoff from buildings can be retained and treated using building BMPs. Permeable pavement can be used to reduce the overall imperviousness of the site and provide for infiltration of runoff. If additional peak discharge reduction, volume reduction, and/or water quality treatment is required to meet the storm water runoff requirements, flows from these BMPs can be routed to infiltration and/or retention/detention BMPs.
- In cases where identified pollutants of concern cannot be reduced using storm water runoff BMPs that simultaneously meet volume reduction and/or peak discharge requirements, a treatment train approach can be employed to first achieve water quality treatment for the pollutants of concern using storm water runoff BMPs that target those pollutants and then effluent from the water quality treatment BMP can be routed to one or more infiltration and/or retention/detention BMP(s) to achieve the volume reduction and peak discharge requirements.
- Where site conditions do not allow for significant use of vegetative BMPs such as biofiltration and building BMPs but do allow for infiltration, all three requirements can be met by using a combination of permeable pavement and underground infiltration BMPs (e.g., infiltration trench) or underground infiltration BMPs alone. In general, if the site allows for infiltration BMPs to be used, volume reduction and water quality treatment requirements can both be met simultaneously regardless of the targeted pollutants of concern as infiltration BMPs provide the best water quality treatment for all pollutants of concern. In some cases, additional detention will be required to meet the peak discharge requirements, which can be achieved using retention/detention BMPs.
- If flow-based BMPs are chosen to achieve the water quality treatment requirement, treated effluent from the flow-based BMPs must be routed to one or more infiltration and/or retention/detention BMPs to achieve the volume reduction and peak discharge requirements with the exception of vegetated swale filters which can be modified to promote infiltration using a subsurface gravel drainage layer. In the modified vegetated swale instance, infiltration and/or retention/detention BMPs may also be required in combination with the modified swale to meet the volume reduction and peak discharge requirements.

- The City's Storm Water Permit and this Manual demonstrate a preference for using infiltration designs to capture and treat storm water. However, infiltration is not the only solution for meeting the City's storm water treatment requirements; the alternatives where infiltration is not recommended include flow-through treatment designs (such as planter boxes and/or vegetated swales with under drains) as well as rain barrels, cisterns, and tanks for containment and later use for landscaping irrigation. For sites where soil conditions limit feasibility of compliance, flow-based BMPs will likely be more practical than for sites with infiltrative soils.
- All or part of the three requirements (i.e., peak discharge reduction, volume reduction, water quality treatment) can be met by modifying traditional detention and/or water quality treatment BMPs to allow for greater infiltration. Such BMPs include dry extended detention (ED) basins, bioretention areas, and vegetated swale filters. Where infiltration is feasible, these BMPs can be retrofitted with a sand filter or planting media layer (dry ED basins) or a gravel drainage layer (bioretention and swales) beneath the BMP to allow for additional volume reduction and treatment of runoff. For these modified BMP types, the facility can be sized to infiltrate the volume reduction requirement and detain flows to meet the peak discharge requirement. The water quality treatment requirement will then likely be met without additional controls being necessary.

## 6.6 Biofiltration and Filtration BMPs

### 6.6.1 Bioretention



**Figure 6-1: Bioretention Area –Arroyo Burro Estuary Restoration Site**

#### Application

- Commercial, residential, mixed use, institutional, and subdivisions
- Parking lot islands, cul-de-sacs, traffic circles
- Road shoulders & medians

#### Advantages

- Provides high pollutant removal and volume reduction
- Can be integrated into landscape areas
- Relatively low maintenance

#### Limitations

- Not recommended for steep slopes
- Requires adequate soils for infiltration
- Adequate depth to groundwater required for infiltration

#### 6.6.1.1 Description

Bioretention areas are vegetated and mulched (i.e., landscaped) shallow depressions that capture and temporarily store storm water runoff. The captured runoff infiltrates through the bottom of the depression and a layer of planting soil, approximately 2 to 4 feet deep, that has an infiltration rate capable of draining the bioretention area (to the bottom of the planting soil) within a specified design drawdown time (usually 10 to 72 hours). Bioretention areas also treat the storm water as it passes through the planting soil. After the storm water infiltrates through the soil media, it infiltrates into the subsoil, if site conditions allow for adequate infiltration and slope protection or the filtered water is directed towards a storm water conveyance system or other storm water runoff BMP via underdrain pipes, if site conditions do not allow for adequate infiltration or slope protection. Bioretention areas are designed to capture a specified design volume and can be configured on-line or off-line. On-line bioretention areas require an overflow system for passing larger storms. Off-line bioretention areas do not require an overflow system but do require freeboard. The planting soil is a mixture that includes mostly sand with smaller fractions of fines (e.g., silts and clays) and organic matter. As storm water passes through the planting soil, pollutants are filtered, adsorbed, biodegraded, and uptaken by plants. Storm

water volume is reduced as it passes through the planting soil via evapotranspiration. If soil conditions allow underdrains to be omitted (i.e., infiltration rates are adequate and slope is not a concern), the remaining storm water passes through the planting soil and infiltrates into the subsoil. Partial infiltration (approximately 20-25%, depending on soil conditions) can still occur when underdrains are present as long as an impermeable interface is not present between the soil media and subsoil. Partial infiltration occurs in these cases since some of the storm water bypasses the underdrain and infiltrates into the subsoil (Strecker *et. al.*, 2004). Bioretention areas shall be planted with grasses, shrubs, and trees that can withstand short periods of saturation (i.e., 10 to 72 hours) followed by longer periods of drought. Bioretention areas are generally not applicable in areas with slopes steeper than 15%. In these cases, planter boxes are more appropriate (see Section 6.9.2).

**6.6.1.2 Applicability, Performance, and Limitations**

Table 6-3, Table 6-4, and Table 6-5 provide a summary of BMP performance, applicability, and limitations for bioretention areas. *It is important to note that information in these tables shall be used to provide general guidance for bioretention areas and shall not replace the evaluation performed by a water quality professional.*

**Applicability and Performance**

Table 6-3 and associated guidance provide general volume reduction capabilities and treatment effectiveness rankings for bioretention areas. Refer to Section 6.4 for the process that shall be used for selecting BMPs based on pollutants of concern. Refer to Table 6-1 to determine the ranking of bioretention areas for removal of pollutants of concern as compared with other storm water runoff BMPs provided in Chapter 6. Refer to Table 6-2 to assess the applicability of bioretention areas for your site based on site suitability considerations as compared with other storm water runoff BMPs provided in Chapter 6. Bioretention areas are volume-based BMPs intended, primarily, for water quality treatment and, depending on site slope and soil conditions, can provide high volume reduction (See Table 6-4). Where site conditions allow, the volume reduction capability of bioretention areas can be enhanced for achieving additional credit towards meeting the volume reduction requirement,  $V_{reduction}$ , by omitting underdrains and providing a gravel drainage layer beneath the bioretention area. Bioretention areas can be used to help meet the peak runoff discharge requirement. See Section 6.2 for specific storm water runoff requirements for Tier 3 projects.

**Table 6-3: Volume Reduction & Treatment Effectiveness for Bioretention Areas**

| Storm Water Runoff BMP   | Volume Mitigation (% of inflow) | Treatment Effectiveness for Pollutants of Concern <sup>1</sup> |           |          |  |          |  |
|--|---------------------------------|--|-----------|----------|--|----------|--|
|  |                                 | Trash  | Nutrients | Bacteria | Metals (particulate and dissolved fractions) | Sediment | Organics (hydrocarbons, oil, and grease) |
| Bioretention   |                                 |  |           |          |  |          |  |
| Volume/Treatment Effectiveness: ● = Very High, ◐ = High, ◑ = Moderate, ◒ = Low, ○ = Very Low |                                 |  |           |          |  |          |  |

<sup>1</sup> Effectiveness may change based on design variations; standard BMP designs have been assumed.

Bioretention areas remove pollutants through physical, chemical, and biological mechanisms. Specifically, they use absorption, microbial activity, plant uptake, sedimentation, and filtration. Bioretention areas provide relatively consistent and high pollutant removal for sediment, metals, and organic pollutants (e.g., hydrocarbons). Most of the sediment removal occurs in the top mulch layer while metals removal commonly occurs within the first 18 inches of the planting soil (Hseih and Davis, 2005; Hunt and Lord, 2006). Removal of nitrogen and phosphorus species is less consistent. Total phosphorus percent removal has been found to vary between a 240% increase (production) and a 99% decrease (removal) (Hunt et. al., 2006; Hseih and Davis, 2005). Greater total phosphorus removal can be achieved by utilizing low P-index (10-30) soil media (Hunt and Lord, 2006). Nitrate removal has been found to vary between a 1% and 80% decrease. Total kjeldhal nitrogen (TKN) has been found to vary between a 5% increase and 65% decrease. Greater nitrate and TKN removal can be achieved by reducing the infiltration rate within the planting soil to 1-2 in/hr and ensuring that the soil media is at least 3 feet deep (Hunt and Lord, 2006). Greater nitrate removal can also be achieved by incorporating a saturated layer within the soil media to promote anaerobic conditions for denitrification (Kim et. al., 2003). Limited data exists for bacteria removal in bioretention areas although most scientists and engineers agree that bacteria die-off occurs at the surface where storm water is exposed to sunlight and the soil can dry out; dense vegetation within the bioretention area can limit the penetration of sunlight and removal of bacteria (Hunt and Lord, 2006).

**Site Suitability Recommendations and Limitations**

Table 6-4 and associated guidance provide general considerations for assessing a site's suitability for bioretention.

**Table 6-4: Site Suitability Considerations for Bioretention Areas**

| BMP          | Tributary Area (Acres; Sq.Ft.) <sup>1</sup> | Site Slope (%)  | Depth to Seasonally High Groundwater Table (ft) | Hydrologic Soil Group                             | Horizontal Setback from Drinking Water Wells (ft) |
|--------------|---|---|---|---|---|
| Bioretention | < 5 Acre; 43,560 Sq. Ft.                    | < 15; planter boxes are generally more suitable for steep slopes <sup>2,3</sup> | > 2 with underdrains; > 5 without underdrains   | Underdrains may be provided for "C" and "D" soils | 100 <sup>4</sup>                                  |

<sup>1</sup> Tributary area is the area of the site draining to the BMP. Tributary areas provided here shall be used as a general guideline only. Tributary areas can be larger or smaller in some instances.

<sup>2</sup> If bioretention area is located within 50 feet of a sensitive steep slope (on the uphill side) or 10 feet from a structure, underdrains are required.

<sup>3</sup> If site slope exceeds 15% or if the bioretention area is within 200 ft from the top of a hazardous slope or landslide area, a geotechnical investigation is required.

<sup>4</sup> Setbacks apply to bioretention areas without underdrains or bioretention areas underlain by "A" or "B" hydrologic soil groups.

Table 6-5 provides additional site applicability considerations for special design districts within the City including coastal bluff areas and hillside design districts.

**Table 6-5: Applicability of Bioretention Areas for Special Design Districts**

| Coastal Bluff Area   | Hillside Design District  |
|--|---|
| Acceptable if: (1) facility is not designed to promote infiltration, (2) underdrains and an impermeable liner are provided regardless of hydrologic soil group (HSG) type, and (3) site slope meets the criteria in Table 6-4. | Acceptable if: (1) a geotechnical investigation proves that the facility does not compromise the stability of the site slope or surrounding slopes, or (2) the facility includes an impermeable liner, underdrain system, and an overflow to a storm water conveyance system, if the facility is on-line. |

The following guidance provides additional site suitability recommendations and limitations for bioretention.

- The tributary area (area draining to the bioretention area) shall be less than 5 acres.
- If located in an area with soil infiltration rates less than 0.05in/hr or greater than 2.4 in/hr, an underdrain shall be provided.
- Groundwater levels shall be at least 2 ft lower than the bottom of the bioretention area if underdrains area provided and 5 ft lower than the bottom of the bioretention area if underdrains are not provided.
- If no underdrains are provided, bioretention areas shall not be placed within 100 feet of the drinking water well.
- If underdrains are provided, site must have adequate relief between land surface and the storm water conveyance system to permit vertical percolation through the soil media and collection and conveyance in underdrain to storm water conveyance system.
- Typically, bioretention areas require between 2 to 6 percent of the tributary area.
- If located in hotspot areas where environmental releases may occur (e.g., industrial sites, gas stations), bioretention areas shall have an underdrain.
- Bioretention areas located within 50 feet of a sensitive steep slope shall incorporate an underdrain. A geotechnical investigation and report must be provided to address the potential effects of infiltration on the steep slope if a bioretention area without an underdrain is sited within 200 feet of the slope or hazardous landslide area.

***Multi-Use and Treatment Train Opportunities***

Bioretention areas can be used to simultaneously meet the storm water runoff requirements, meet landscaping requirements, achieve aesthetic goals, enhance wildlife functions, and/or



provide public education. The following is a list of settings where bioretention may be incorporated to meet more than one project-level or watershed-scale objective:

- Landscaped areas on individual lots
- Areas within loop roads or cul-de-sacs
- Landscaped parking lot islands
- Within rights-of-way along roads.
- Common landscaped areas in apartment complexes or other multi-family residential designs.
- In parks and along open space edges.

In addition, bioretention areas can be combined with other basic and storm water runoff BMPs to form a “treatment train” that can provide enhanced water quality treatment and reductions in runoff volume and rate. For example, runoff can be collected from a roadway in a vegetated swale that then flows to a bioretention area. Both facilities can be reduced in size based upon demonstrated performance for meeting the storm water runoff requirements as outlined in Section 6.2 and addressing targeted pollutants of concern. In addition, bioretention areas can serve the dual purpose of storm water management and landscape design and can significantly enhance the aesthetics of a site.

**6.6.1.3 Design Criteria and Procedure**

Bioretention areas shall be designed according to the current requirements of the City of Santa Barbara and the Santa Barbara County Flood Control and Water Conservation District. Standard design criteria for bioretention areas are listed in Table 6-6. A schematic of a bioretention area is provided in Figure 6-2.

**Table 6-6: Bioretention Area Design Criteria**

| Design Parameter                                       | Unit            | Design Criteria   |
|--|-----------------|---|
| Water quality design volume, $V_{wq}$                  | ft <sup>3</sup> | See Section 6.2 and Appendix C for calculating $V_{wq}$ .   |
| Volume reduction requirement, $V_{reduction}$          | ft <sup>3</sup> | See Section 6.2 and Appendix C for calculating $V_{reduction}$ .  |
| Pretreatment   | -               | Filter strip, vegetated swale, or forebay for all surfaces other than roofs; if sheet flow, max velocity = 1 ft/sec |
| Drawdown time of planting soil                         | hrs             | 48  |
| Drawdown time of gravel drainage layer (if applicable) | hrs             | 72  |
| Maximum ponding depth                                  | inches          | 12  |
| Planting soil depth                                    | feet            | 2; 3 preferred  |
| Stabilized mulch depth                                 | inches          | 2 to 3  |
| Planting media composition                             | -               | 60 to 70% sand, 15 to 25% compost, and 10 to 20% clean topsoil; organic content 8 to 12%; pH 5.5 to 7.5             |

| Design Parameter | Unit | Design Criteria                              |
|------------------|------|--|
| Underdrain       | -    | 6 inch. minimum diameter; 0.5% minimum slope |
| Overflow device  | -    | Required if system is on-line                |

### ***Pretreatment***

1. Bioretention areas shall use a filter strip, vegetated swale, or forebay to pretreat incoming flows from impervious surfaces. Bioretention areas that treat runoff from residential roofs or other “cleaner” surfaces do not require pretreatment.
2. If sheet flow is conveyed to the treatment area over stabilized grassed areas, the site must be graded in such a way that minimizes erosive conditions. Sheet flow velocities shall not exceed 1 foot per second.

### ***Geometry and Size***

1. Bioretention areas shall have a maximum ponding depth of 12 inches.
2. Planting soil depth shall be a minimum of 2 feet, although 3 feet is preferred. *Intent: The planting soil depth shall provide a beneficial root zone for the chosen plant palette and adequate water storage for the water quality design volume. A deeper planting soil depth will provide a smaller surface area footprint.*
3. Bioretention areas shall be designed to drain to below the planting soil depth in less than 48 hours. If a gravel drainage layer is included beneath the bioretention area planting soil, stored runoff in the drainage layer shall be designed to drain in less than 72 hours. *Intent: Soils must be allowed to dry out periodically in order to restore hydraulic capacity to receive flows from subsequent storms, maintain infiltration rates, maintain adequate soil oxygen levels for healthy soil biota and vegetation, and to provide proper soil conditions for biodegradation and retention of pollutants.*

### ***Sizing Methodology***

Bioretention areas shall be sized to capture and treat the water quality design volume,  $V_{wq}$ , and where site conditions allow, shall also be sized to infiltrate the volume reduction requirement,  $V_{reduction}$ . See Section 6.2 and Appendix C for the storm water runoff requirements and calculations. Procedures for sizing infiltration BMPs are summarized below. A bioretention area sizing example is provided in Appendix D.

Step 1: Determine the design infiltration rate

The design infiltration rate,  $k_{\text{design}}$ , will differ depending on whether the bioretention area will have underdrains. If the bioretention area includes underdrains, then the design infiltration rate will be that of the planting media which shall be determined using lab infiltration testing (see Chapter 3). If the bioretention area does not include underdrains, then the design infiltration rate will be the limiting infiltration rate (slowest) of the planting media and the native subsoil. In most cases, the limiting infiltration rate will be that of the native subsoil.

Determining the design infiltration rate,  $k_{\text{design}}$ , of the native subsoil

The initial infiltration rate of the native subsoil will decline over time as the surface settles and becomes more compacted and as sediments accumulate in the pore spaces of the infiltration layer. Monitoring of actual facility performance has shown that the full-scale infiltration rate is far lower than the rate measured by small-scale testing as described in Chapter 3. It is important that adequate conservatism is incorporated in the selection of design infiltration rates. The design infiltration rate discussed here is the infiltration rate of the underlying soils and not the infiltration rate of the planting media (refer to the "Planting/Storage Media" section below for the recommended composition of the planting media for bioretention areas).

A simplified method may be used for determining the design infiltration rate by applying correction factors to the field measured infiltration rate. These factors take into account uncertainty in measurement procedure, depth to water table or impermeable strata, infiltration facility geometry, and long term reductions in permeability due to biofouling and accumulation of fines.

$$k_{\text{design}} = k_{\text{measured}} \times F_{\text{testing}} \times F_{\text{plugging}} \times F_{\text{geometry}} \quad (\text{Equation 6-1})$$

Where:

- $k_{\text{design}}$  = design infiltration rate (in/hr)
- $k_{\text{measured}}$  = field measures infiltration rate (in/hr)
- $F_{\text{testing}}$  = correction factor for testing method
- $F_{\text{plugging}}$  = correction factor for soil plugging
- $F_{\text{geometry}}$  = correction factor for facility geometry

$F_{\text{testing}}$  takes into account uncertainties in the testing method and is 0.3 for small-scale percolation tests and 0.5 for large-scale testing.

$F_{\text{plugging}}$  accounts for reductions in infiltration rates over the long term caused by plugging of soils. The factor is:

- 0.7 for loams and sandy loams
- 0.8 for fine sands and loamy sands
- 0.9 for medium sands
- 1.0 for coarse sands or cobbles or for any facility preceded by a full specification filter strip or vegetated swale.

$F_{geometry}$  accounts for the influence of facility geometry and depth to groundwater table or impervious strata on the actual infiltration rate.  $F_{geometry}$  must be between 0.25 and 1.0 as determined by the following equation:

$$F_{geometry} = 4 D/W + 0.05 \quad (\text{Equation 6-2})$$

Where:

- $D$  = depth from the bottom of the facility to the maximum seasonally high groundwater table or nearest impervious layer, whichever is less (ft)
- $W$  = width of the facility (ft)

Note that adjusted infiltration rate ( $k_{design}$ ) may be different for basins, trenches, and dry wells installed in the same location due to differences in dimension.

### Step 2: Sizing Calculations

Bioretention areas can be sized using one of two methods: a simple sizing method or a routing modeling method. With either method, the runoff entering the facility must completely drain the ponding area and the planting media within 48 hours. If the bioretention areas includes a gravel drainage layer, the drainage layer must drain in 72 hours. The sizing of the gravel drainage layer is much like the sizing of the gravel storage layer for permeable pavement. See the permeable pavement Section 6.8 for these calculations. Bioretention areas provide storage above ground, in the voids of the planting media, and (if used) in the voids of gravel drainage layer.

**Simple Sizing Method.** If the bioretention area is to be designed with underdrains, the volume for design,  $V_{design}$ , is equal to  $V_{wq}$ . If the bioretention are is designed without underdrains where site conditions allow for infiltration, the volume for design,  $V_{design}$  is the greater of  $V_{reduction}$  and  $V_{wq}$ .  $V_{design}$  will fill the available ponding depth, the void spaces in the planting media, and (if used) the gravel drainage layer. Determine the surface area of the bioretention area (bottom area) using the following equation based on Darcy's law.

$$A = \frac{(V_{design})(l)}{(t)(k_{design})(d+l)} \quad (\text{Equation 6-3})$$

(Adapted from Georgia Stormwater Manual: <http://www.atlantaregional.com/environment/georgia-stormwater-manual>)

Where:

- $V_{design}$  = design volume of runoff to be infiltrated (ft<sup>3</sup>)
- $k_{design}$  = design infiltration rate (in/hr); if underdrains are provided, infiltration rate of planting media; if no underdrains provided, infiltration rate of the subsoil
- $d$  = ponding depth (ft)
- $l$  = depth of planting media (ft)
- $t$  = required drawdown time (hr); maximum is 48 hours

**Routing Method.** A continuous runoff model, such as US EPA's SWMM Model, can be used to optimally size a sand filter. A continuous simulation model consists of three components: (1) a representative long term period of rainfall data ( $\approx 20$  years or greater) as the primary model input, (2) a model component representing the tributary area to the bioretention area that takes into account the amount of impervious area, soil types of the pervious area, vegetation, evapotranspiration, etc., and (3) a component that simulates the bioretention area. Using this method, the bioretention area shall be sized to capture and treat the water quality design volume,  $V_{wq}$ , or, if site conditions allow, the volume reduction requirement,  $V_{reduction}$  from the post-development tributary area; whichever is larger.

The continuous simulation model routes predicted tributary runoff to the bioretention area, where treatment is simulated as a function of the infiltrative (flow) capacity of the bioretention area and the available storage volume above the bioretention area. In a continuous runoff model such as SWMM, the physical parameters of the bioretention area are represented with stage-storage-discharge relationships. Due to the computational power of ordinary desktop computers, long-term continuous simulations generally take only minutes to run. This allows the modeler to run several simulations for a range of bioretention area sizes, varying either the surface area of the bioretention area (and resulting flow capacity) or the storage capacity above the bioretention area, or both. Sufficient continuous model simulations shall be completed so that results encompass the water quality treatment and/or volume reduction capture goal.

Model results shall be plotted for both varying storage depths above the bioretention area and for varying bioretention area surface areas (and resulting flow capacity) while keeping all other parameters constant. The resulting relationship of percent capture as a function of bioretention area flow and storage capacity can be used to optimally size a bioretention area based on site conditions and constraints.

In addition to continuous simulation modeling, routing spreadsheets, and/or other forms of routing modeling that incorporate rainfall-runoff relationships and infiltrative (flow) capacities of bioretention areas may be used to size facilities. Alternative sizing methodologies shall be prepared with good engineering practices.

### ***Flow Entrance and Energy Dissipation***

The following types of flow entrance can be used for bioretention areas:

1. Dispersed, low velocity flow across a landscape area. Dispersed flow may not be possible given space limitations or if the facility is controlling roadway or parking lot flows where curbs are mandatory.
2. Dispersed flow across pavement or gravel and past wheel stops for parking areas.
3. Flow spreading trench around perimeter of bioretention area. May be filled with pea gravel (i.e., pea gravel diaphragm) or vegetated with 3:1 side slopes similar to a vegetated swale. A vertical-walled open trench may also be used at the discretion of the City.
4. Curb cuts/slotted wheel stops for roadside or parking lot areas. Curb cuts/slotted wheel stops shall include rock or other erosion protection material at flow entrance to dissipate

energy. Flow entrance shall drop 2 to 3 inches from curb line and provide an area for settling and periodic removal of sediment and coarse material before flow dissipates to the remainder of the cell.

5. Pipe flow entrance: Piped entrances, such as roof downspouts, shall include rock, splash blocks, or other erosion protection material at the entrance to dissipate energy and disperse flows.
6. Woody plants (trees, shrubs, etc.) can restrict or concentrate flows and can be damaged by erosion around the root ball and shall not be placed directly in the entrance flow path.

### ***Underdrains***

If underdrains are required, then they must meet the following criteria:

1. 6-inch minimum diameter.
2. Underdrains must be made of slotted, polyvinyl chloride (PVC) pipe conforming to ASTM D 3034 or equivalent or corrugated high density polyethylene (HDPE) pipe conforming to AASHTO 252M or equivalent. *Intent: As compared to round-hole perforated pipe, slotted underdrains provide greater intake capacity, clog resistant drainage, and reduced entrance velocity into the pipe, thereby reducing the chances of solids migration.*
3. Slotted pipe shall have 2 to 4 rows of slots cut perpendicular to the axis of the pipe or at right angles to the pitch of corrugations. Slots shall be 0.04 to 0.1-inch and shall have a length of 1-inch to 1.25-inch. Slots shall be longitudinally spaced such that the pipe has a minimum of one square inch per lineal foot.
4. Underdrains shall be sloped at a minimum of 0.5%.
5. Rigid non-perforated observation pipes with a diameter equal to the underdrain diameter shall be connected to the underdrain every 250 to 300 feet to provide a clean-out port as well as an observation well to monitor dewatering rates. The wells/cleanouts shall be connected to the perforated underdrain with the appropriate manufactured connections. The wells/cleanouts shall extend 6 inches above the top elevation of the bioretention facility mulch, and shall be capped with a lockable screw cap. The ends of underdrain pipes not terminating in an observation well/cleanout shall also be capped.

- The following aggregate shall be used to provide a gravel blanket and bedding for the underdrain pipe. Place the underdrain on a 3-foot wide bed of the aggregate at a minimum thickness of 6 inches and cover with the same aggregate to provide a 1-foot minimum depth around the top and sides of the slotted pipe.

| Sieve size | Percent Passing |
|------------|-----------------|
| ¾ inch     | 100             |
| ¼ inch     | 30-60           |
| US No. 8   | 20-50           |
| US No. 50  | 3-12            |
| US No. 200 | 0-1             |

- At the option of the designer, a geotextile fabric may be placed between the planting media and the drain rock. If a geotextile fabric is used it must meet the following minimum materials requirements. Another option is to place a thin, 2- to 4-inch layer of pure sand and a thin layer (nominally two inches) of choking stone (such as #8) between the planting media and the drain rock.

| Geotextile Property    | Value           | Test Method |
|------------------------|-----------------|-------------|
| Trapezoidal Tear (lbs) | 40 (min)        | ASTM D4533  |
| Permeability (cm/sec)  | 0.2 (min)       | ASTM D4491  |
| AOS (sieve size)       | #60 - #70 (min) | ASTM D4751  |
| Ultraviolet resistance | 70% or greater  | ASTM D4355  |

- The underdrain must drain freely to an acceptable discharge point. The underdrain can be connected to a downstream open conveyance (vegetated swale), to another bioretention cell as part of a connected treatment system, daylight to a vegetated dispersion area using an effective flow dispersion device, stored for reuse, or to a storm water conveyance system.

**Overflow**

If the bioretention area is on-line, an overflow device is required at the 12-inch ponding depth. Two options are provided:

Option 1: Vertical riser

- A vertical PVC pipe (SDR 35) shall be connected to the underdrain.
- The overflow riser(s) shall be 6 inches or greater in diameter, so it can be cleaned without damage to the pipe. The vertical pipe will provide access to cleaning the underdrains.
- The inlet to the riser shall be 12 inches above the planting media, and be capped with a spider cap.

Option 3: Pea Gravel Curtain Drain (if underdrain is provided)

1. A pea gravel drain shall be installed on the downslope edge of the bioretention area.
2. The top surface of the drain shall be 12 inches above the planting media surface, and supported by 4:1 (H:V) berm of planting media on the upstream side.
3. The curtain drain will be 12" wide and at least as long as maximum width of the bioretention area.
4. The curtain drain will be connected directly to the gravel bed supporting the drainage pipe.
5. A geotextile meeting the specifications above shall be placed vertically between the curtain drain and the planting media.

Option 3: Flow spreader

1. A flow spreader shall be installed along a section of the exit edge or outflow section of the bioretention area.
2. The top surface of the flow spreader shall be 6 inches above the planting media surface.

***Hydraulic Restriction Layers***

Infiltration pathways may need to be restricted due to the close proximity of roads, foundations, other infrastructure, or hotspot locations. Three types of restricting layers can be incorporated into bioretention designs:

1. Filter fabric can be placed along vertical walls to reduce lateral flows.
2. Clay (bentonite) liners can be used. If so, underdrain system is also required.
3. Geomembrane liners shall have a minimum thickness of 30 mils.

***Planting/Storage Media***

1. The planting media placed in the cell shall be highly permeable and high in organic matter (e.g., loamy sand mixed thoroughly with compost amendment) and a surface mulch layer.
2. Planting media shall consist of 60 to 70% sand, 15 to 25% compost, and 10 to 20% clean topsoil. The organic content of the soil mixture shall be 8% to 12%; the pH range shall be 5.5 to 7.5.
3. Sand shall be free of stones, stumps, roots or other similar objects larger than 5 millimeters, and have the following gradation:

| Particle Size (ASTM D422) | % Passing |
|---------------------------|-----------|
| #4                        | 100       |
| #6                        | 88-100    |



|      |       |
|------|-------|
| #8   | 79-97 |
| #50  | 11-35 |
| #200 | 5-15  |

4. Compost shall be free of stones, stumps, roots or other similar objects larger than ¾ inches; have a particle size of 98% passing through ¾" screen or smaller; and meet the following characteristics:

- Soluble Salt Concentration: < 10 mmhos/cm (dS/m)
- pH: 5.0-8.5
- Moisture: 30-60% wet weight basis
- Organic Matter: 30-65% dry weight basis
- Stability (Carbon Dioxide evolution rate): >80% relative to positive control
- Maturity (Seed emergence and seedling vigor): >80% relative to positive control
- Physical contaminants: < 1% dry weight basis

5. Topsoil shall be free of stones, stumps, roots or other similar objects larger than 2 inches, and have the following characteristics:

- Soluble salts: < 4.0 mmhos/cm (dS/m)
- pH range: 5.5 to 7.0
- Organic matter: > 5%
- Carbon to Nitrogen Ratio: < 20:1
- Moisture content: 25-55%

| Particle Size (ASTM D422, D1140) | % Passing |
|----------------------------------|-----------|
| ¾"                               | 98        |
| Sand (0.05 - 2.0 mm )            | 50-75     |
| Silt (0.002 - 0.05 mm)           | 15-40     |
| Clay                             | < 5       |

6. The bioretention area shall be covered with mulch when constructed and annually replaced to maintain adequate mulch depth. *Intent: this will help sustain nutrient levels, suppress weeds, and maintain infiltrative capacity.* Mulch shall be:

- Well-aged, shredded or chipped woody debris or plant material. Well-aged mulch is defined as mulch that has been stockpiled or stored for at least twelve (12) months. Compost meeting the requirements above may also be used (compost is less likely to float and is a better source for organic materials).
- Free of weed seeds, soil, roots, and other material that is not bole or branch wood and bark.
- Mulch depth shall be 2 to 3 inches thick (*intent: thicker applications can inhibit proper oxygen and carbon dioxide cycling between the soil and atmosphere*).
- Grass clippings or pure bark shall not be used as mulch.

7. Planting media design height shall be marked appropriately, such as a collar on the vertical riser (if installed), or with a stake inserted 2 feet into the planting media and notched to show bioretention surface level and ponding level.
8. The bioretention soil mix shall be tested and meet the following criteria:

| Item  | Criteria              | Test Method |
|---|-----------------------|-------------|
| Corrected pH  | 5.5 – 7.5             | ASTM D4972  |
| Magnesium   | Minimum 32 ppm        | *           |
| Phosphorus (Phosphate - P <sub>2</sub> O <sub>5</sub> ) | Not to exceed 69 ppm  | *           |
| Potassium (K <sub>2</sub> O)                            | Minimum 78 ppm        | *           |
| Soluble Salts   | Not to exceed 500 ppm | *           |

\* Use authorized soil test procedures.

Should the pH fall outside of the acceptable range, it may be modified with lime (to raise) or iron sulfate plus sulfur (to lower). The lime or iron sulfate must be mixed uniformly into the soil mix prior to use in bioretention areas.

Should the soil mix not meet the minimum requirement for magnesium, it may be modified with magnesium sulfate. Likewise, should the soil mix not meet the minimum requirement for potassium, it may be modified with potash. Magnesium sulfate and potash must be mixed uniformly into the soil mix prior to use in bioretention areas.

Limestone. Limestone shall contain not less than 85 percent calcium and magnesium carbonates. Dolomitic (magnesium) limestone shall contain at least 10 percent magnesium as magnesium oxide and 85 percent calcium and magnesium carbonates.

Limestone shall conform to the following gradation:

| Sieve Size | Minimum Percent Passing By Weight |
|------------|-----------------------------------|
| No. 10     | 100                               |
| No. 20     | 98                                |
| No. 100    | 50                                |

Iron Sulfate. Iron sulfate shall be a constituent of an approved horticultural product produced as a fertilizer for supplying iron and as a soil acidifier.

Magnesium Sulfate. Magnesium sulfate shall be a constituent of an approved horticultural product produced as a fertilizer.

Potash. Potash (potassium oxide) shall be a constituent of an approved horticultural product produced as a fertilizer.

***Gravel Drainage Layer***

If site conditions allow (i.e., soil infiltration rate and site slope are adequate), the volume reduction capability bioretention areas can be enhanced by omitting the underdrain and installing an appropriately sized gravel drainage layer (typically a washed 57 stone) beneath the planting soil to achieve the desired volume reduction goals. The base of the drainage layer shall have zero slope (level). The drawdown time for the gravel drainage layer shall not exceed 72 hours. The planting soil and gravel layers shall be separated with a geotextile filter fabric (as specified above) or with a thin, 2- to 4-inch layer of pure sand and a thin layer (nominally two inches) of choking stone (such as #8). Sizing of the gravel drainage layer is the same as for permeable pavement, see Section 6.8 for sizing calculations.

***Vegetation***

Bioretention area vegetation shall have the following characteristics:

1. Plant materials shall be tolerant of summer drought, ponding fluctuations, and saturated soil conditions for 48 to 72 hours.
2. It is recommended that a minimum of three tree, three shrubs, and three herbaceous groundcover species be incorporated to protect against facility failure due to disease and insect infestations of a single species. Plant rooting depths shall not damage the underdrain, if present. Slotted or perforated underdrain pipe shall be more than 5 feet from tree locations (if space allows).
3. Native plant species and/or hardy cultivars that are not invasive and do not require chemical inputs shall be used to the maximum extent practicable.
4. Shade trees shall have a single main trunk. Trunks shall be free of branches below the following heights:

| Caliper (in)   | Height (ft) |
|----------------|-------------|
| 1-1/2 to 2-1/2 | 5           |
| 3              | 6           |

5. See Appendix G for a recommended native plant list for bioretention areas, a list of local nurseries where these plants can be purchased, and a list of local and regional on-line resources. The plant list in Appendix G shall be used as a guide only and shall not replace project-specific planting recommendations provided by a landscape professional including recommendations on appropriate plants, fertilizer, mulching applications, and irrigation requirements (if any) to ensure healthy vegetation growth. See Section 5.11 for more information on landscaping/planting recommendations and Section 5.10 for more information on soil amendment recommendations.

**6.6.1.4 Construction Considerations**

The use of treated wood or galvanized metal anywhere inside the facility is prohibited.

Figure 6-2: Bioretention Area Schematic

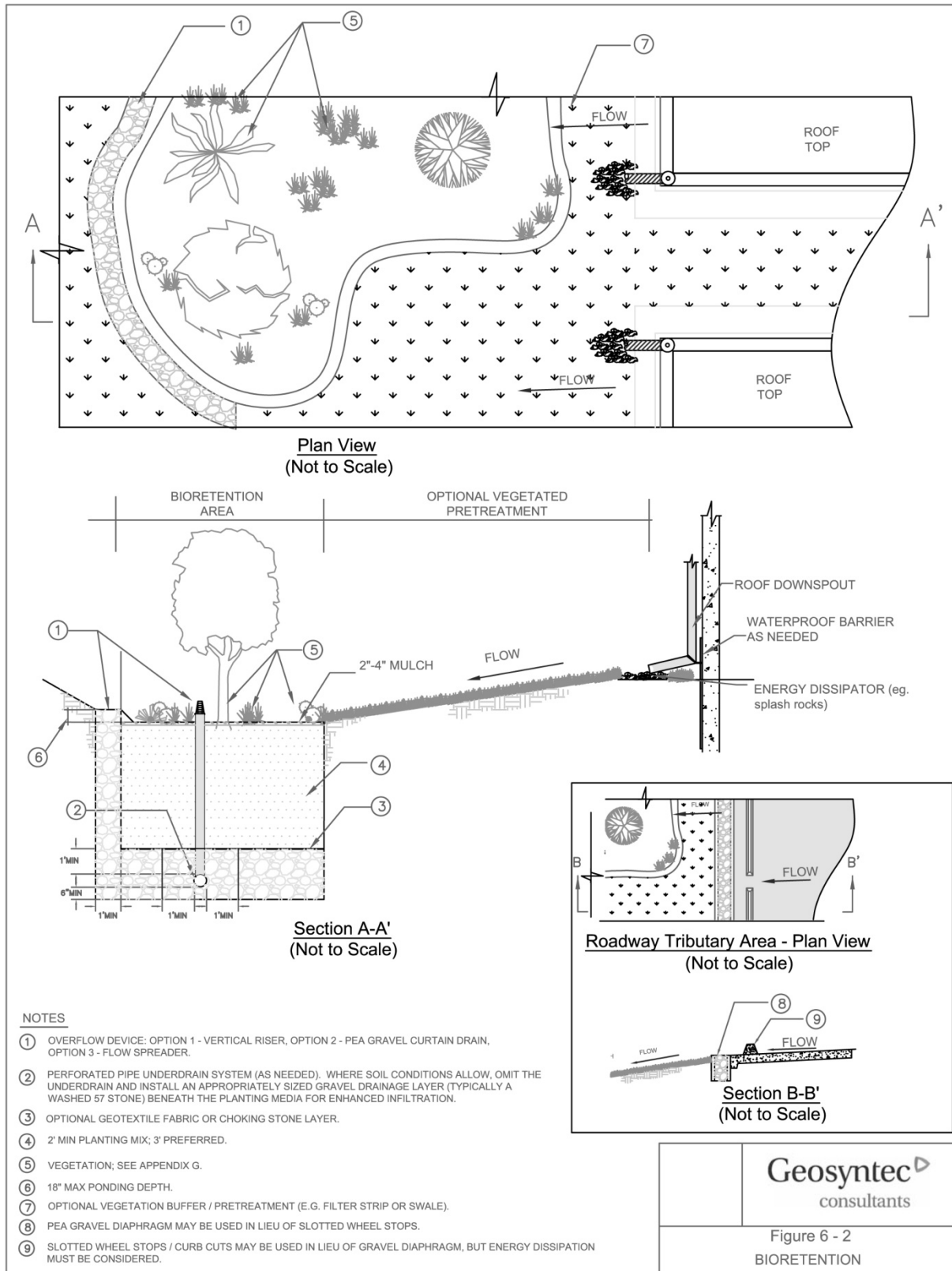

Geosyntec  
consultants

Figure 6 - 2  
BIORETENTION

### 6.6.1.5 Operations and Maintenance

#### *General Requirements*

Bioretention areas require annual plant, soil, and mulch layer maintenance to ensure optimum infiltration, storage, and pollutant removal capabilities. In general, bioretention maintenance requirements are typical landscape care procedures and include:

1. Watering: Plants shall be selected to be drought tolerant and not require watering after establishment (2 to 3 years). Watering may be required during prolonged dry periods after plants are established.
2. Erosion control: Inspect flow entrances, ponding area, and surface overflow areas periodically, and replace soil, plant material, and/or mulch layer in areas if erosion has occurred (see Appendix H for a bioretention inspection and maintenance checklist). Properly designed facilities with appropriate flow velocities shall not have erosion problems except perhaps in extreme events. If erosion problems occur the following shall be reassessed: (1) flow velocities and gradients within the cell, and (2) flow dissipation and erosion protection strategies in the pretreatment area and flow entrance. If sediment is deposited in the bioretention area, immediately determine the source within the contributing area, stabilize, and remove excess surface deposits.
3. Plant material: Depending on aesthetic requirements, occasional pruning and removing of dead plant material may be necessary. Replace all dead plants and if specific plants have a high mortality rate, assess the cause and, if necessary, replace with more appropriate species. Periodic weeding is necessary until plants are established. The weeding schedule shall become less frequent if the appropriate plant species and planting density have been used and, as a result, undesirable plants excluded.
4. Nutrient and pesticides: The soil mix and plants are selected for optimum fertility, plant establishment, and growth. Nutrient and pesticide inputs should not be required and may degrade the pollutant processing capability of the bioretention area, as well as contribute pollutant loads to receiving waters. By design, bioretention areas are located in areas where phosphorous and nitrogen levels are often elevated and these should not be limiting nutrients. If in question, have soil analyzed for fertility.
5. Mulch: Replace mulch annually in bioretention areas where heavy metal deposition is likely (e.g., contributing areas that include industrial and auto dealer/repair parking lots and roads). In residential lots or other areas where metal deposition is not a concern, replace or add mulch as needed to maintain a 2 to 3 inch depth at least once every two years.
6. Soil: Soil mixes for bioretention areas are designed to maintain long-term fertility and pollutant processing capability. Estimates from metal attenuation research suggest that metal accumulation should not present an environmental concern for at least 20 years in bioretention systems. Replacing mulch in bioretention areas where heavy metal deposition is likely provides an additional level of protection for prolonged performance. If in question, have soil analyzed for fertility and pollutant levels.

***Maintenance Standards***

A summary of the routine and major maintenance activities recommended for bioretention areas is shown in Table 6-7. Detailed routine and major maintenance standards are listed in Table 6-8 and Table 6-9.

**Table 6-7: Bioretention Maintenance Quick Guide**

| <b>Inspection and Maintenance Activities Summary</b> |   |
|--|---|
| <b>Routine Maintenance</b>                           | <ul style="list-style-type: none"> <li>• Repair small eroded areas and ruts by filling with gravel. Overseed bare areas to reestablish vegetation</li> <li>• Remove trash and debris and rake surface soils to mitigate ponding</li> <li>• Remove accumulated fine sediments, dead leaves, and trash to restore surface permeability</li> <li>• Remove any evidence of visual contamination from floatables such as oil and grease</li> <li>• Eradicate weeds and prune back excess plant growth that interferes with facility operation. Remove non-native vegetation and replace with native species</li> <li>• Remove sediment and debris accumulation near inlet and outlet structures to alleviate clogging</li> <li>• Clean and reset flow spreaders (if present) as needed to restore original function</li> <li>• Mow routinely to maintain ideal grass height and to suppress weeds</li> <li>• Periodically observe function under wet weather conditions</li> </ul> |
| <b>Major Maintenance</b>                             | <ul style="list-style-type: none"> <li>• Repair structural damage to flow control structures including inlet, outlet, and overflow structures</li> <li>• Clean out under-drain, if present, to alleviate ponding. Replace media if ponding or loss of infiltrative capacity persists and re-vegetate</li> <li>• Re-grade and re-vegetate to repair damage from severe erosion/scour channelization and to restore sheet flow</li> <li>• Photographs taken before and after major maintenance is encouraged</li> </ul>   |

**Table 6-8: Routine Maintenance – Bioretention**

| <b>Defect or Problem</b>          | <b>Condition When Maintenance is Needed</b>  | <b>Results Expected When Maintenance Is Performed</b>  | <b>Frequency</b>  |
|-----------------------------------|--|--|---|
| Erosion                           | Splash pads or spreader incorrectly placed; eroded or scoured areas due to flow channelization, or higher flows. | No erosion on surface of basin. No erosion or scouring evident. For ruts or bare areas less than 12 inches wide, damaged areas repaired by filling with crushed gravel. The grass will creep in over the rock in time. | Annually prior to wet season.<br><br>After major storm events (>0.75 in/24 hrs) if spot checks of some basins indicate widespread damage/ maintenance needs |
| Standing Water                    | When water stands in the basin between storms and does not drain freely (with 36- 48 hours after storm event).   | Water drains completely from basin as designed and surface is clear of trash and debris. Underdrains (if installed) are cleared.   | Monthly (or as dictated by agreement between County and landscape contractor)   |
| Loss of surface permeability      | Accumulation of fine sediments, dead leaves, trash and other debris on surface                                   | Surface permeability restored. Surface layer removed and replaced with fresh mulch.  |   |
| Visual contaminants and pollution | Any visual evidence of oil, gasoline, contaminants or other pollutants.  | No visual contaminants or pollutants present.  |   |
| Vegetation                        | Weeds, excessive plant growth, plants interfering with basin operation, plants diseased or dying                 | Basin tidy, plants healthy and pruned. Any plants that interfere with function are removed. Invasive or non-acclimated plants replaced.  |   |
| Inlet/Overflow                    | Inlet/outlet areas clogged with sediment and/or debris.  | Material removed so that there is no clogging or blockage of the inlet or overflow area.   |   |
| Trash and debris                  | Any trash and debris which exceed 5 cubic feet per 1,000 square feet (one standard garbage can).                 | Trash and debris removed and facility looks well kept.   |   |



**Table 6-9: Major Maintenance – Bioretention**

| <b>Defect or Problem</b> | <b>Condition When Maintenance is Needed</b>  | <b>Results Expected When Maintenance Is Performed</b>                                  | <b>Frequency</b>             |
|--------------------------|--|--|------------------------------|
| Standing water           | When water stands in the basin between storms and does not drain freely (with 36- 48 hours after storm event). | planting media (sand, gravel, and topsoil) and vegetation removed and replaced.        | Annually prior to wet season |
| Erosion/<br>Scouring     | Bare spots greater than 12 inches  | No erosion on surface of basin. Large bare areas are re-graded and reseeded/replanted. | As needed                    |

### 6.6.2 Vegetated Swale Filter



**Figure 6-3: Roadside Swale**

*Photo Credit: Geosyntec Consultants*

#### 6.6.2.1 Description

Vegetated swale filters (vegetated swales) are open, shallow channels with low-lying vegetation covering the side slopes and bottom that collect and slowly convey runoff flow to downstream discharge points. Vegetated swales provide pollutant removal through settling and filtration in the vegetation (usually grasses) lining the channels. In addition, they provide the opportunity for volume reduction through infiltration and evapotranspiration, and reduce the flow velocity in addition to conveying storm water runoff. Where soil conditions allow, volume reduction in vegetated swales can be enhanced by adding a gravel drainage layer underneath the swale allowing additional flows to be retained and infiltrated. Where slopes are shallow and soil conditions limit or prohibit infiltration, an underdrain system or low flow channel for dry weather flows may be required to minimize ponding and convey treated and/or dry weather flows to an acceptable discharge point.

An effective vegetated swale achieves uniform sheet flow through a densely vegetated area for a period at least 10 minutes. The vegetation in the swale can vary depending on its location within a development project and is the choice of the designer, depending on the functional criteria outlined below. When appropriate, swales that are integrated within a project may use turf or other more intensive landscaping, while swales that are located on the project perimeter, within a park, or close to an open space area are encouraged to be planted with a more naturalistic plant palette.

A vegetated swale can be designed either on-line or off-line. On-line vegetated swales are used for conveying high flows as well as providing treatment of the water quality design flow rate, and can replace curbs, gutters, and storm drain systems. On-line vegetated swales are sized to

#### Applications

- Commercial and institutional
- Multi-family and mixed use
- Parking lots, road shoulders and medians
- Open spaces, parks, golf courses

#### Advantages

- Combines stormwater treatment with runoff conveyance
- Often less cost than curb & gutter
- Volume & peak flow reduction
- Pollutant removal

#### Limitations

- Higher maintenance than curb and gutter
- Not applicable for steep slopes
- May interfere with flood control function of existing conveyances and detention

treat flows up to the flow-based water quality treatment design flow rate,  $Q_{wq}$ , and act as a storm water conveyance channel for storms greater than the water quality design storm flow rate. No treatment is credited for storms that produce flow rates greater than  $Q_{wq}$  because the ratio of flow depth to vegetation height is small due to increased flow depths and decreased vegetation height (e.g., vegetation gets pushed horizontal when flow depths increase to greater than two-thirds of the vegetation height) which limits the amount of filtering that can occur for storms greater than the  $Q_{wq}$ . On-line vegetated swales shall be designed to convey flow rates up to the post-development peak storm water runoff discharge rate (flow rate) for the 100-yr 24-hour storm event, with appropriate freeboard (See Santa Barbara County Flood Control and Water Conservation District Standard Conditions of Project Plan Approval). Exceptions to the required freeboard are inlets or safe surface conveyances to carry excess water into a storm water conveyance system that might occur in parking lots, for example. Whenever possible, inflow shall be directed towards the upstream end of the swale as much as possible, but shall at a minimum occur evenly over the length of the swale. Flow velocities shall be limited in on-line swales as much as possible to minimize re-entrainment of sediment and associated pollutants.

If designed off-line, a flow diversion structure (i.e., flow splitter) is used to divert the  $Q_{wq}$  to the off-line vegetated swale designed to handle  $Q_{wq}$ . Freeboard for off-line swales is not required, but shall be provided if space is available.

#### **6.6.2.2 Applicability, Performance, and Limitations**

Table 6-10, Table 6-11, and Table 6-12 provide a summary of BMP performance, applicability, and limitations for vegetated swale filters. *It is important to note that information in these tables shall be used to provide general guidance for vegetated swale filters and shall not replace the evaluation performed by a water quality professional.*

##### ***Applicability and Performance***

Table 6-10 and associated guidance provide general volume reduction capabilities and treatment effectiveness rankings for vegetated swale filters. Refer to Section 6.4 for the process that shall be used for selecting BMPs based on pollutants of concern. Refer to Table 6-1 to determine the ranking of vegetated swale filters for removal of pollutants of concern as compared with other storm water runoff BMPs provided in Chapter 6. Refer to Table 6-2 to assess the applicability of vegetated swale filters for your site based on site suitability considerations as compared with other storm water runoff BMPs provided in Chapter 6. Vegetated swales are flow-based BMPs intended, primarily, for water quality treatment and, depending on site slope and soil conditions, can provide some volume reduction. They can be designed to enhance infiltration for achieving credit towards meeting the volume reduction requirement,  $V_{\text{reduction}}$ . Where site conditions allow (See Table 6-11), the volume reduction capabilities of vegetated swales can be designed to enhance infiltration for achieving credit towards meeting the volume reduction requirement,  $V_{\text{reduction}}$ , by eliminating underdrains and providing a gravel drainage layer beneath the vegetated swale. Vegetated swales are not intended to be a primary BMP for meeting the peak runoff discharge requirement, although they do assist in reducing the peak runoff discharge rate by increasing the site's time of concentration,  $T_c$ , and decreasing runoff volumes and velocities. See Section 6.2 for specific storm water runoff requirements for Tier 3 projects.

**Table 6-10: Volume Reduction & Treatment Effectiveness for Vegetated Swale Filters**

| Storm Water Runoff BMP   | Volume Mitigation (% of inflow) | Treatment Effectiveness for Pollutants of Concern <sup>1</sup> |           |          |  |          |  |
|--|---------------------------------|--|-----------|----------|--|----------|--|
|  |                                 | Trash  | Nutrients | Bacteria | Metals (particulate and dissolved fractions) | Sediment | Organics (hydrocarbons, oil, and grease) |
| Vegetated Swale Filter   | ●                               | ◐  | ○         | ●        | ●  | ●        | ●  |
| Volume/Treatment Effectiveness: ● = Very High, ◐ = High, ◑ = Moderate, ◒ = Low, ○ = Very Low |                                 |  |           |          |  |          |  |

<sup>1</sup> Effectiveness may change based on design variations; standard BMP designs have been assumed.

Vegetated swales are a good candidate for the removal of sediment and particulate bound pollutants through filtration. The effectiveness of vegetated swale filters can be enhanced by adding check dams or appropriate trees at approximately 50 foot increments along their length. These dams maximize the retention time within the swale, decrease flow velocities, and promote particulate settling. The incorporation of vegetated filter strips parallel to the top of the channel banks can help to treat sheet flows entering the swale.

#### Site Suitability Recommendations and Limitations

Table 6-11 and associated guidance provide general considerations for assessing a site's suitability for vegetated swales.

**Table 6-11: Site Suitability Considerations for Vegetated Swale Filters**

| BMP                    | Tributary Area (Acres; Sq.Ft.) <sup>1</sup> | Site Slope (%)   | Depth to Seasonally High Groundwater Table (ft) | Hydrologic Soil Group | Horizontal Setback from Drinking Water Wells (ft) |
|------------------------|---|--|---|-----------------------|---|
| Vegetated Swale Filter | < 5 Acres; 217,800 Sq.Ft.                   | < 10 site slope; 1 to 6 longitudinal slope of swale <sup>2,3</sup> | > 2 with underdrains; > 5 without underdrains   | Any <sup>3</sup>      | 100 <sup>4</sup>                                  |

<sup>1</sup> Tributary area is the area of the site draining to the BMP. Tributary areas provided here shall be used as a general guideline only. Tributary areas can be larger or smaller in some instances.

<sup>2</sup> If site slope exceeds 10% or if the swale is within 200 ft from the top of a hazardous slope or landslide area, a geotechnical investigation is required. If the longitudinal slope of the swale exceeds 6%, check dams (e.g., drop structures) shall be provided.

<sup>3</sup> If the swale is located within 50 feet of a sensitive steep slope on the uphill side or 10 feet from a structure, has a longitudinal slope less than 1.5% and has poorly drained soils (hydrologic soil groups "C" or "D"), or is located in a coastal bluff area or a hillside design district, underdrains shall be incorporated.

<sup>4</sup> Setbacks apply to systems without underdrains or systems underlain by "A" or "B" hydrologic soil groups.

Table 6-12 provides additional site applicability considerations for special design districts within the City including coastal bluff areas and hillside design districts.

**Table 6-12: Applicability of Vegetated Swale Filters for Special Design Districts**

| Coastal Bluff Area  | Hillside Design District  |
|---|---|
| Acceptable if: (1) facility is not designed to promote infiltration, (2) underdrains and an impermeable liner are provided regardless of hydrologic soil group (HSG) type, and (3) site slope meets the criteria in Table 6-11. | Acceptable if: (1) a geotechnical investigation proves that the facility does not compromise the stability of the site slope or surrounding slopes, or (2) the facility includes an impermeable liner, underdrain system, and an overflow to a storm water conveyance system, if the facility is on-line. |

The following provides additional site suitability recommendations and limitations for vegetated swale.

- Limit the tributary area (area draining to the BMP) and associated longitudinal slope (parallel to the flow) to less than 5 acres and less than 10%, respectively. *Intent: reduces the potential for high flow velocity and concentrated, erosive flows entering the vegetated swale.*
- The longitudinal slope over the length of the swale can be up to 6% before concentrated, erosive flows become potentially problematic. Check dams (e.g., drop structures) shall be provided for slopes that exceed 6%.
- *Mild longitudinal slope (<1.5%) over the length of the vegetated swale along with poorly drained soils including hydrologic soil groups "C" or "D" (e.g., silts and clays) can cause ponding. Underdrains shall be provided in these cases. In any case, longitudinal slope shall not be less than 1%. A soils report shall be provided to verify soils properties for swales less than 1.5%.*
- Require at least 100 feet in length if the vegetated swale will be used to meet the water quality treatment requirements. The vegetated swale can be shorter than 100 feet if it is used for pretreatment.
- Cannot be applied in areas with highly erodible soils.
- Groundwater levels shall be at least 2 ft lower than the swale surface if underdrains are provided and 5 ft lower than the swale surface to ensure that the swale does not remain wet between storms.
- May not be applicable adjacent to industrial sites or locations where environmental releases may occur depending on the filtration capabilities of the swale.
- Shall not be located in areas with excessive shade to avoid poor vegetative growth. For moderately shaded areas, shade tolerant plants shall be used.
- Shall not be located near too many large trees that may drop leaves or needles. Excessive tree debris may smother the grass or impede the flow through the swale.

***Multi-Use and Treatment Train Opportunities***

A vegetated swale can be combined with other basic and storm water runoff BMPs to form a “treatment train” that provides enhanced water quality treatment and reductions in runoff volume and rate. For example, if a vegetated swale is placed upgradient of a dry extended detention (ED) basin, the rate and volume of water flowing to the dry ED basin can be reduced and the water quality enhanced. As another example, dry ED basins may be placed upstream a vegetated swale to reduce the size of the vegetated swale. In both cases, each facility can be reduced in size accordingly based upon demonstrated performance for meeting the storm water runoff requirements as outlined in Section 6.2 and addressing targeted pollutants of concern. In addition, vegetated swales can be incorporated into the landscape design of a site and can be aesthetically pleasing as well as functional. When appropriate, swales that are integrated within a project may use turf or other more intensive landscaping, while swales that are located on the project perimeter, within a park, or close to an open space area are encouraged to be planted with a more naturalistic plant palette.

**6.6.2.3 Design Criteria and Procedure**

Vegetated swales shall be designed according to the current requirements of the City of Santa Barbara and the Santa Barbara County Flood Control and Water Conservation District. Standard design criteria for vegetated swale filters are listed in Table 6-13. A schematic of a vegetated swale is illustrated in Figure 6-5. Schematics of check dams and flow spreaders are illustrated in Figure 6-6.

**Table 6-13: Vegetated Swale Filter Design Criteria**

| Design Parameter                              | Unit            | Design Criteria  |
|---|-----------------|--|
| Water quality design flow rate, $Q_{wq}$      | cfs             | See Section 6.2 and Appendix C for calculating $Q_{wq}$ .  |
| Volume reduction requirement, $V_{reduction}$ | ft <sup>3</sup> | See Section 6.2 and Appendix C for calculating $V_{reduction}$   |
| Swale Geometry                                | -               | Trapezoidal  |
| Minimum bottom width                          | feet            | 2  |
| Maximum bottom width                          | feet            | 10; if greater than 10 must use swale dividers; with dividers, max is 16   |
| Minimum length                                | feet            | 100 or at least 10 minute residence (contact) time   |
| Maximum channel side slope                    | H:V             | <ul style="list-style-type: none"> <li>• 2:1 for total swale depth &lt; 1 ft</li> <li>• 3:1 for total swale depth &gt; 1 ft or for mowed grass swales</li> </ul> |
| Minimum slope in flow direction               | %               | 1 (provide underdrains for slopes between 1 and 1.5 that have poorly drained soils – hydrologic soil group “C” or “D”. )   |
| Maximum slope in flow direction               | %               | 6.0 (provide check dams for slopes > 6.0)  |
| Maximum flow velocity                         | ft/sec          | 1.0 (water quality treatment); 3.0 (flood conveyance)  |
| Maximum depth of flow for water               | inches          | 4 for infrequently mowed vegetated swales; 2 for frequently  |

| Design Parameter                 | Unit    | Design Criteria  |
|----------------------------------|---------|--|
| quality treatment                |         | mowed turf swales (ideally flow depth is 2 inches less than vegetation height) |
| Minimum residence (contact) time | minutes | >7 (provide sufficient length to yield minimum residence time)                 |
| Vegetation type                  | --      | Varies (see vegetation section below and Appendix G)                           |
| Vegetation height                | inches  | 4 to 6 (trim or mow to maintain height)  |

### ***Geometry and Size***

1. In general, trapezoidal channel shape shall be assumed for sizing calculations above, but a more naturalistic channel cross-section is preferred.
2. Swales designed for water quality treatment purposes only are anticipated to be fairly shallow, generally less than 1-foot. Therefore, a side slope of 2:1 (H:V) can be used and is acceptable. Milder slopes are necessary for mowed turf swales (3H:1V max.).
3. Overall depth from the top of the side walls to the swale bottom shall be at least 12 inches.
4. Swale length shall be greater than 100 feet in length. Regardless of the recommended detention time, the swale shall be not less than 100 feet in length if the vegetated swale will be used to meet the water quality treatment requirements. The vegetated swale can be shorter than 100 feet if it is used for pretreatment. Length can be increased by meandering the swale.
5. The minimum swale bottom width shall be 2 feet to allow for ease of mowing.
6. The maximum swale bottom width shall be limited to 10 feet, unless a dividing berm is provided, then maximum bottom width can be 16 feet. Swale width is calculated without the diving berm. *Intent: Experience shows that when the width exceeds about 10 feet, it is difficult to keep the water from concentrating in low-flow channels. It is also difficult to construct the bottom level and without sloping to one side. Vegetated swales are best constructed by leveling the bottom after excavating. A single-width pass with a front-end loader produces a better result than a multiple-width pass.*
7. Swales that are required to convey flood as well as water quality flows shall be sized to convey the post-development peak storm water discharge rate for the 100-yr 24-hr storm event and include 2 feet of freeboard, unless it can be demonstrated that the swale freeboard is not needed because runoff would be safely be conveyed to an alternative drainage system (such as a parking lot).
8. Gradual meandering bends in the swale are desirable for aesthetic purposes and to promote slower flow.

***Bottom Slope***

1. The longitudinal slope (along the direction of flow) shall be between 1% and 6%.
2. If longitudinal slopes are less than 1.5% and the soils are poorly drained (e.g., silts and clays), then underdrains shall be provided. A soils report to verify soils properties shall be provided for swales less than 1.5%.
3. If longitudinal slope exceeds 6%, check dams with vertical drops of 12 inches or less shall be provided to achieve a bottom slope of 6% or less between the drop structures.
4. The lateral (horizontal) slope at the bottom of the swale shall be zero (flat) to discourage channeling.

***Water Depth and Dry Weather Flow Drain***

1. Water depth shall not exceed 4 inches, except for frequently mowed turf swales (as in commercial or landscaped areas), the depth shall not exceed 2 inches.
2. The swale length must provide a minimum hydraulic residence time of 10 minutes.
3. If soil and slope conditions require, a low flow drain shall be provided for dry weather flows extending the entire length of the swale. The drain shall have a minimum depth of 6 inches, and a width no more than 5% of the calculated bottom swale width; the width of the drain shall be in addition to the required bottom width. If an anchored plate is used for flow spreading at the swale inlet, the plate wall shall have v-notches (maximum top width = 5% of swale width) or holes to allow preferential exit of low flows into the drain. If an underdrain or gravel drainage layer is installed as discussed below, the low flow drain shall be omitted.

***Sizing Methodologies***

The flow capacity of a vegetated swale is a function of the longitudinal slope (parallel to flow), the resistance to flow (e.g., Manning's roughness), and the cross sectional area. The cross section is normally approximately trapezoidal and the area is a function of the bottom width and side slopes. The flow capacity of vegetated swales shall be such that the design water quality flow rate will not exceed a flow depth of 2/3 the height of the vegetation within the swale or 4 inches at the peak of the water quality design storm intensity. Once design criteria have been selected, the resulting flow depth for the design water quality flow rate is checked. If the depth restriction is exceeded, swale parameters (e.g., longitudinal slope, width) are adjusted to reduce the flow depth.

A vegetated swale sizing example is provided in Appendix D.

***Step 1: Select design flows and design volume reduction (if applicable)***

Vegetated swales are flow-based BMPs and are designed based on the water quality design flow rate,  $Q_{wq}$ . If a gravel drainage layer is to be included for promoting infiltration and gaining credit towards the volume reduction requirement,  $V_{reduction}$ , see the gravel drainage layer



discussion below. Sizing of the gravel drainage layer is not provided in these steps. For calculating the  $Q_{wq}$  and  $V_{reduction}$ , see Section 6.2 and Appendix C.

***Step 2: Determine flow depth, d, and swale bottom width, b***

There are two procedures for determining design flow depth, d, and swale bottom width, b. One is a spreadsheet procedure and the other is a graphical procedure. Both procedures use a trial and error method for solving Manning's equation for a trapezoidal open channel when the longitudinal channel slope, Manning's roughness, and design flow rate are known. The general Manning's equation is as follows assuming the design flow rate is  $Q_{wq}$ :

$$Q_{wq} = \frac{1.49}{n} AR^{\frac{2}{3}} s^{\frac{1}{2}} \quad (\text{Equation 6-4})$$

Where:

- $Q_{wq}$  = design flow rate (cfs)
- $n$  = Manning's roughness coefficient (unitless)
- $A$  = cross-sectional area of flow (ft<sup>2</sup>)
- $R$  = hydraulic radius (ft) = area divided by wetted perimeter
- $s$  = longitudinal channel slope (along direction of flow) (ft/ft)

For the purposes of the trial and error process, Manning's Equation can be rearranged as:

$$AR^{\frac{2}{3}} = (Q_{wq})(n)/(b^{\frac{8}{3}})(s^{\frac{1}{2}}) \quad (\text{Equation 6-5})$$

***Spreadsheet Procedure***

To determine the design flow depth, d, and bottom width, b, by the spreadsheet procedure, trial values of bottom width and flow depth are used to determine A, P, and R for the given channel cross section. Trial values of  $AR^{2/3}$  are computed until the equality of Equation 6-5 is satisfied such that the design flow rate,  $Q_{wq}$ , is conveyed for the selected cross section and such that flow depth, bottom width, and channel slope are within acceptable ranges. The equations for A and R for a trapezoidal channel are provided here:

$$A = (b + zd)d \quad (\text{Equation 6-6})$$

$$R = \frac{A}{P} \quad (\text{Equation 6-7})$$

$$P = b + 2d(1 + z^2)^{0.5} \quad (\text{Equation 6-8})$$

**Graphical Procedure**

A graphical procedure can also be used for simplifying trial and error solutions if the spreadsheet procedure is unavailable. The graphical procedure utilizes the trapezoidal channel capacity chart in Figure 6-4.

**Step 2.1:** Determine input data including design flow rate,  $Q_{wq}$ , Manning's  $n$  value, channel bottom depth,  $b$ , channel slope,  $s$ , and channel side slope,  $Z$ .

**Step 2.2:** Calculate the trapezoidal conveyance factor using the equation:

$$K_T = (Q_{wq})(n)/(b^{\frac{8}{3}})(s^{\frac{1}{2}}) \quad (\text{Equation 6-9})$$

Where:

- $K_T$  = trapezoidal open channel conveyance factor
- $Q_{wq}$  = design flow rate (cfs)
- $n$  = Manning's roughness coefficient (unitless)
- $b$  = channel bottom width (ft)
- $s$  = longitudinal channel slope (along direction of flow) (ft/ft)

**Step 2.3:** Enter the x-axis of Figure 6-4 with the value of  $K_T$  calculated from Step 2.2 and draw a line vertically to the curve corresponding to the appropriate  $Z$  value from Step 2.1.

**Step 2.4:** From the point of intersection obtained in Step 2.3, draw a horizontal line to the y-axis and read the value of the normal depth of flow over the bottom width,  $d/b$ .

**Step 2.5:** Multiply the  $d/b$  from Step 2.4 by  $b$  to obtain normal depth of flow,  $d$ . Continue the trial and error process until the desired flow depth is obtained. Maximum flow depth for infrequently mowed vegetated swales shall be 4 inches and maximum flow depth for frequently mowed turf swales shall be 2 inches.

A minimum 2-foot bottom width is required. The maximum allowable bottom width is 10 feet; therefore, if the bottom width exceeds 10 feet, then one of the following steps is necessary to reduce the design bottom width:

- a. Increase the longitudinal slope ( $s$ ) to a maximum of 6 feet in 100 feet (0.06 feet per foot).
- b. Increase the design flow depth ( $d$ ) to a maximum of 4 inches.
- c. Place a divider lengthwise along the swale bottom (Figure 6-6) at least three-quarters of the swale length (beginning at the inlet), without compromising the design flow depth and swale lateral slope requirements. Swale width can be increased to an absolute maximum of 16 feet if a divider is provided.

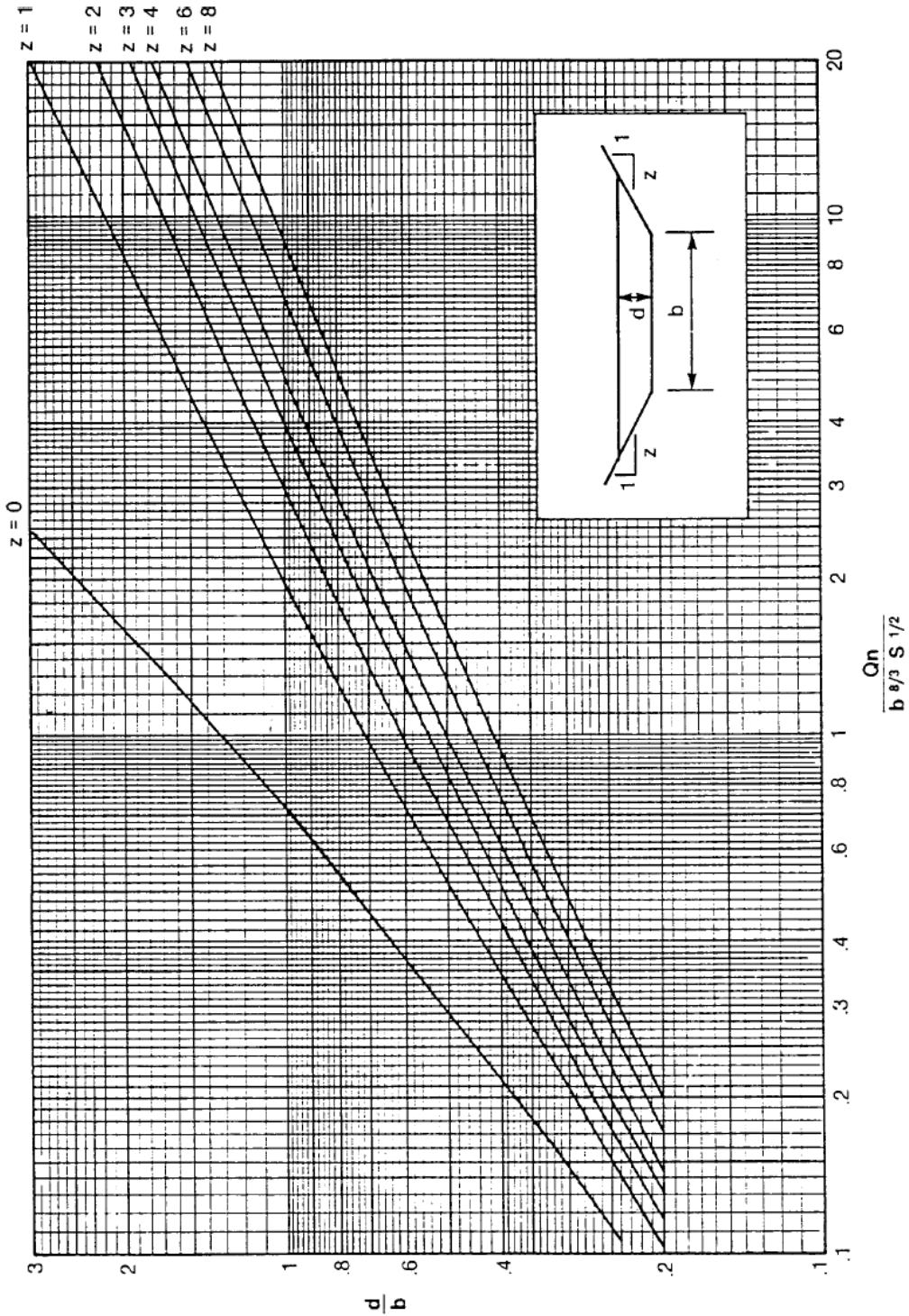

Figure 6-4: Trapezoidal Channel Capacity Chart

Step 3: Determine design flow velocity

To calculate the design flow velocity through the swale, use the flow continuity equation:

$$V_{wq} = Q_{wq} / A_{wq} \quad (\text{Equation 6-10})$$

Where:

$V_{wq}$  = design flow velocity (fps)

$A_{wq}$  =  $bd + Zd^2$  = cross-sectional area ( $\text{ft}^2$ ) of flow at design depth, where  $Z$  = side slope length per unit height (e.g.,  $Z = 3$  if side slopes are 3H:1V)

If the design flow velocity exceeds 1 foot per second, go back to Step 2 and modify one or more of the design parameters (longitudinal slope, bottom width, or flow depth) to reduce the design flow velocity to 1 foot per second or less. If the design flow velocity is calculated to be less than 1 foot per second, proceed to Step 4. *Note: It is desirable to have the design velocity as low as possible, both to improve treatment effectiveness and to reduce swale length requirements.*

Step 4: Calculate swale length

Use the following equation to determine the necessary swale length to achieve a hydraulic residence time of at least 10 minutes (600 seconds):

$$L = 600V_{wq} \quad (\text{Equation 6-11})$$

Where:

$L$  = swale length (ft)

$V_{wq}$  = design flow velocity (fps)

The minimum swale length is 100 feet; therefore, if the swale length is calculated to be less than 100 feet, increase the length to a minimum of 100 feet, leaving the bottom width unchanged. If a larger swale could be fitted on the site, consider using a greater length to increase the hydraulic residence time and improve the swale's pollutant removal capability. If the calculated length is too long for the site, or if it would cause layout problems, such as encroachment into shaded areas, proceed to Step 5 to further modify the layout. If the swale length can be accommodated on the site, proceed to Step 6.

Step 5: Adjust swale layout to fit on site

If the swale length calculated in Step 4 is too long for the site, the length can be reduced (to a minimum of 100 feet) by increasing the bottom width up to a maximum of 16 feet, as long as the 10 minute retention time is retained. However, the length cannot be increased in order to reduce the bottom width because Manning's depth-velocity-flow rate relationships would not be preserved. If the bottom width is increased to greater than 10 feet, a low flow dividing berm is needed to split the swale cross section in half to prevent channelization.

Length can be adjusted by calculating the top area of the swale and providing an equivalent top area with the adjusted dimensions.

Step 5.1: Calculate the swale treatment top area based on the swale length calculated in Step 4:

$$A_{top} = (b_i + b_{slope})L_i \quad \text{(Equation 6-12)}$$

Where:

- $A_{top}$  = top area (ft<sup>2</sup>) at the design treatment depth
- $b_i$  = bottom width (ft) calculated in Step 2
- $b_{slope}$  = the additional top width (ft) above the side slope for the design water depth (for 3:1 side slopes and a 4-inch water depth,  $b_{slope} = 2$  feet)
- $L_i$  = initial length (ft) calculated in Step 4.

Step 5.2: Use the swale top area and a reduced swale length  $L_f$  to increase the bottom width, using the following equation:

$$L_f = A_{top} / (b_f + b_{slope}) \quad \text{(Equation 6-13)}$$

Where:

- $L_f$  = reduced swale length (ft)
- $b_f$  = increased bottom width (ft)

Step 5.3: Recalculate  $V_{wq}$  according to Step 3 using the revised cross-sectional area  $A_{wq}$  based on the increased bottom width  $b_f$ . Revise the design as necessary if the design flow velocity exceeds 1 foot per second.

Step 5.4: Recalculate to assure that the 10 minute retention time is retained.

Step 6: Provide conveyance capacity for flows higher than  $Q_{wq}$

Vegetated swales may be designed as flow-through channels (on-line) that convey flows higher than the water quality design flow rate,  $Q_{wq}$ , or they may be designed to incorporate a high-flow bypass (off-line) upstream of the swale inlet. A high-flow bypass, using a flow splitter structure, usually results in a smaller swale size. If a high-flow bypass is provided, this step is not needed. If no high-flow bypass is provided, proceed with the procedure below. Flow splitter design specifications are described in Appendix F.

Step 6.1: Check the swale size to determine whether the swale can convey the post-development peak storm water discharge rate for the 100-yr 24-hr storm event (See Section 6.2.3 and Appendix C).

**Step 6.2:** The post-development peak storm water runoff velocity must be less than 3.0 feet per second. If this velocity exceeds 3.0 feet per second, return to Step 2 and increase the bottom width or flatten the longitudinal slope as necessary to reduce the post-development peak storm water runoff to 3.0 feet per second or less. If the longitudinal slope is flattened, the swale bottom width must be recalculated (Step 2) and must meet all design criteria.

### ***Swale Inflow and Design Capacity***

1. Whenever possible, inflow shall be directed towards the upstream end of the swale but shall, at a minimum, occur evenly over the length of the swale.
2. On-line vegetated swales shall be designed to convey flow rates up to the post-development peak storm water runoff discharge rate (flow rate) for the 100-yr 24-hour storm event, with appropriate freeboard (See Santa Barbara County Flood Control and Water Conservation District Standard Conditions of Project Plan Approval). Exceptions to the required freeboard are inlets or safe surface conveyances to carry excess water into a storm water conveyance system that might occur in parking lots, for example.
3. Off-line vegetated swales shall be designed to convey the flow-based water quality design flow rate,  $Q_{wq}$ , by using a flow diversion structure (e.g., flow splitter) which diverts the  $Q_{wq}$  to the off-line vegetated swale designed to handle  $Q_{wq}$ . Freeboard for off-line swales is not required, but shall be provided if space is available. Flow splitter design specifications are described in Appendix F.

### ***Energy Dissipation***

1. Vegetated swales may be designed either on-line or off-line. If the facility is on-line, velocities shall be maintained below the maximum design flow velocity of 3 feet per second to prevent scour and resuspension of deposited sediments.
2. The maximum flow velocity under the water quality design flow rate shall not exceed 1.0 foot per second. *Intent: This maximum water quality design flow velocity promotes settling and keeps vegetation upright.*
3. This velocity limitation combined with a maximum depth of 4 inches and bottom width of 10 feet results in a recommended maximum flow capacity of about 3.3 cfs, after accounting for the side slopes. The contributory drainage area to each swale is limited so as not to exceed this recommended maximum flow capacity.
4. The maximum flow velocity during the 100-yr 24-hr storm event shall not exceed 3.0 foot per second. This can be accomplished by:
  - a. Splitting roadside swales near high points in the road so that flows drain in opposite directions, mimicking flow patterns on the road surface.
  - b. Limiting tributary areas to long swales by diverting flows throughout the length of the swale at regular intervals, to the downstream storm water conveyance system.

5. A flow spreader (see "Flow Spreaders" below) shall be used at the inlet so that the entrance velocity is quickly dissipated and the flow is uniformly distributed across the whole swale. Energy dissipation controls shall be constructed of sound materials such as stones, concrete, or proprietary devices that are rated to withstand the energy of the influent flows.
6. If check dams are used to reduce the longitudinal slope, a flow spreader shall be provided at the toe of each vertical drop, with specifications described below.
7. If flow is to be introduced through curb cuts, place pavement slightly above the elevation of the vegetated areas. Curb cuts shall be at least 12 inches wide to prevent clogging.

### ***Flow Spreaders***

1. An anchored plate flow spreader shall be provided at the inlet to the swale. Equivalent methods for spreading flows evenly throughout the width the swale are acceptable.
2. The top surface of the flow spreader plate shall be level, projecting a minimum of 2 inches above the ground surface of the water quality facility, or v-notched with notches 6 to 10 inches on center and 1 to 4 inches deep (use shallower notches with closer spacing).
3. A flow spreader plate shall extend horizontally beyond the bottom width of the facility to prevent water from eroding the side slope and shall have a row of horizontal perforations at the base of the plate to prevent ponding for long durations. The horizontal extent shall be such that the bank is protected for all flows up to the 100-yr 24-hr storm event (on-line swales) or the maximum flow that will enter the WQ facility (off-line swales).
4. Flow spreader plates shall be securely fixed in place.
5. Flow spreader plates may be made of either concrete, stainless steel, fiberglass reinforced plastic, or other durable material.
6. Anchor posts shall be 4-inch square concrete, tubular stainless steel, or other material resistant to decay.

### ***Check Dams***

If check dams are required, they can be designed out of a number of different materials, including riprap, earthen berms, or removal stop logs. Check dams must be placed as to achieve the desired slope (<6%) at a maximum of 50 feet apart. Check dams shall be no higher than 12 inches. If riprap is used, the material shall consist of well-graded stone consisting of a mixture of rock sizes. The following is an example of an acceptable gradation:

| Particle Size | % Passing |
|---------------|-----------|
| 24"           | 100       |
| 15"           | 75        |
| 9"            | 50        |
| 4"            | 10        |

***Underdrains***

If underdrains (not to be confused with a dry weather flow drain) are required, then they must meet the following criteria:

1. Underdrains must be made of slotted, polyvinyl chloride (PVC) pipe conforming to ASTM D 3034 or equivalent or corrugated high density polyethylene (HDPE) pipe conforming to AASHTO 252M or equivalent. *Intent: As compared to round-hole perforated pipe, slotted underdrains provide greater intake capacity, clog resistant drainage, and reduced entrance velocity into the pipe, thereby reducing the chances of solids migration.*
2. Slotted pipe shall have 2 to 4 rows of slots cut perpendicular to the axis of the pipe or at right angles to the pitch of corrugations. Slots shall have a width of 0.04-inch to 0.1-inch and shall have a length of 1-inch to 1.25-inch. Slots shall be spaced such that the pipe has a minimum of one square inch per lineal foot.
3. The pipe must be 6 inches or greater in diameter, so it can be cleaned without damage to the pipe. Clean-out risers with diameters equal to the underdrain pipe must be placed at the terminal ends of the underdrain and can be incorporated into the flow spreader and outlet structure to minimize maintenance obstacles in the swale. Intermediate clean-out risers may also be placed in the check dams or grade control structures. The cleanout risers shall be capped with a lockable screw cap.
4. The underdrain shall be placed parallel to the swale bottom and backfilled and bedded with six inches of drain rock. The following aggregate shall be used to provide a gravel blanket and bedding for the underdrain pipe to provide a 1-foot minimum depth around the top and sides of the slotted pipe.

| Sieve size | Percent Passing |
|------------|-----------------|
| ¾ inch     | 100             |
| ¼ inch     | 30-60           |
| US No. 8   | 20-50           |
| US No. 50  | 3-12            |
| US No. 200 | 0-1             |



- The drain rock must be separated from the soil layer above with either a geotextile filter fabric meeting the following minimum materials requirements or with a thin, 2- to 4-inch layer of pure sand and a thin layer (nominally two inches) of choking stone (such as #8).

| Geotextile Property    | Value           | Test Method |
|------------------------|-----------------|-------------|
| Trapezoidal Tear (lbs) | 40 (min)        | ASTM D4533  |
| Permeability (cm/sec)  | 0.2 (min)       | ASTM D4491  |
| AOS (sieve size)       | #60 - #70 (min) | ASTM D4751  |
| Ultraviolet resistance | 70% or greater  | ASTM D4355  |

- The underdrain must infiltrate into the subsurface or drain freely to an acceptable discharge point.

### ***Gravel Drainage Layer***

- To increase volume reduction and if soil conditions allow (infiltration rate > 0.05 in/hr), omit the low flow drain or underdrain and install an appropriately sized gravel drainage layer (typically a washed 57 stone) beneath the swale to achieve desired volume reduction goals. Where slopes are greater than 1%, the gravel drainage layer shall be installed in combination with check dams (e.g., drop structures) to slow the flow in the swale and allow for infiltration into the gravel drainage layer and then into the subsurface. The base of the drainage layer shall have zero slope. The drawdown time in the gravel drainage layer shall not exceed 72 hours. The soil and gravel layers shall be separated with a geotextile filter fabric or a thin, 2- to 4-inch layer of pure sand and a thin layer (nominally two inches) of choking stone (such as #8). Sizing of the gravel drainage layer is based on volume reduction requirements.

### ***Swale Divider***

- If a swale divider is used, the divider shall be constructed of a firm material that will resist weathering and not erode, such as concrete, plastic, or compacted soil seeded with grass. Treated timber shall not be used. Selection of divider material must take into account maintenance activities, such as mowing.
- The divider must have a minimum height of 1 inch greater than the water quality design water depth.
- Earthen berms shall be no steeper than 2H:1V.
- Material other than earth shall be embedded to a depth sufficient to be stable.

### ***Soils***

- Swale soils shall be amended with 2 inches of well-rotted compost, unless the organic content is already greater than 10%. The compost shall be mixed into the native soils to a depth of 6 inches to prevent soil layering and washout of compost. The compost will contain no sawdust, green or under-composted material, or any other toxic or harmful

substance. It shall contain no un-sterilized manure, which can lead to high levels of pathogen indicators (coliform bacteria) in the runoff. See Section 5.10 for more guidance on soil amendments.

### ***Vegetation***

Swales must be vegetated in order to provide adequate treatment of runoff via filtration. Vegetation, when chosen and maintained appropriately, also improves the aesthetics of a site. It is important to maximize water contact with vegetation and the soil surface.

1. The swale area shall be appropriately vegetated with a mix of erosion-resistant plant species that effectively bind the soil. A diverse selection of low growing plants that thrive under the specific site, climatic, and watering conditions shall be specified. A mixture of dry-area and wet-area grass species that can continue to grow through silt deposits is most effective. Native or adapted grasses are preferred because they generally require less fertilizer, limited maintenance, and are more drought resistant than exotic plants. When appropriate, swales that are integrated within a project may use turf or other more intensive landscaping, while swales that are located on the project perimeter, within a park, or close to an open space area are encouraged to be planted with a more naturalistic plant palette.
2. Trees or shrubs may be used in the landscape as long as they do not over-shade the turf.
3. Above the design treatment elevation, a typical lawn mix or landscape plants can be used provided they do not shade the swale vegetation.
4. Irrigation is required if the seed is planted in spring or summer. Use of a permanent irrigation system may help provide maximal water quality performance. Drought-tolerant grasses shall be specified to minimize irrigation requirements.
5. Vegetative cover shall be at least 4 inches in height, ideally 6 inches. Swale water depth shall ideally be 2 inches below the height of the shortest plant species and shall not exceed 4 inches.
6. Locate the swale in an area without excessive shade to avoid poor vegetative growth. For moderately shaded areas, shade tolerant plants shall be used.
7. Locate the swale away from large trees that may drop excessive leaves or needles. Excessive tree debris may smother the grass or impede the flow through the swale. Landscape planter beds shall be designed and located so that soil does not erode from the beds and enter a nearby swale.
8. See Appendix G for a recommended native plant list for vegetated swale filters, a list of local nurseries where these plants can be purchased, and a list of local and regional on-line resources. The plant list in Appendix G shall be used as a guide only and shall not replace project-specific planting recommendations provided by a landscape professional including recommendations on appropriate plants, fertilizer, mulching applications, and irrigation requirements (if any) to ensure healthy vegetation growth. See Section 5.11 for more

information on landscaping/planting recommendations and Section 5.10 for more information on soil amendment recommendations.

#### **6.6.2.4 Construction Recommendations**

The use of treated wood or galvanized metal anywhere inside the facility is prohibited.

Figure 6-5: Vegetated Swale Filter Schematic

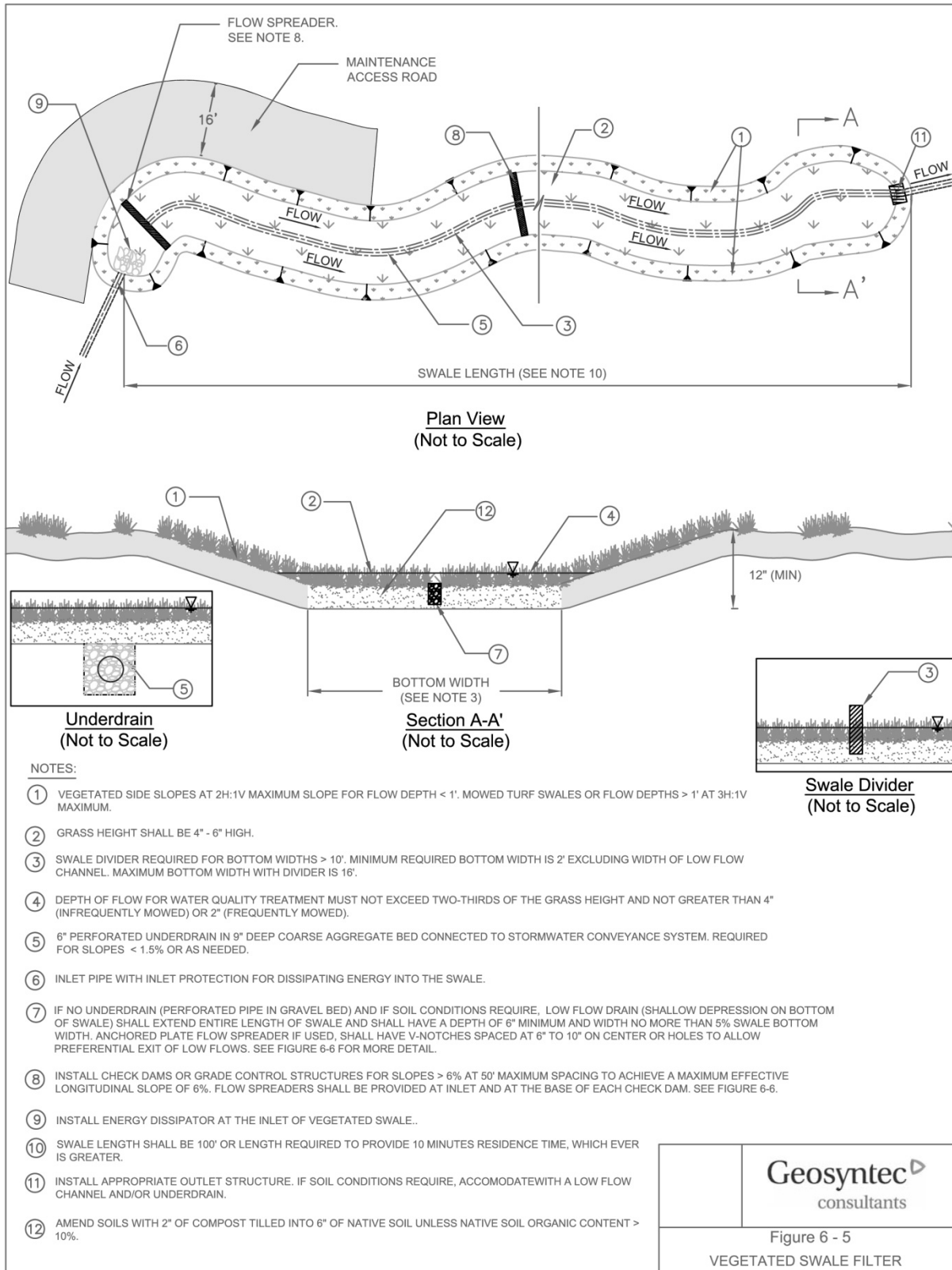

Geosyntec  
consultants

Figure 6 - 5  
VEGETATED SWALE FILTER

**Figure 6-6: Flow Spreader and Check Dam Schematics**

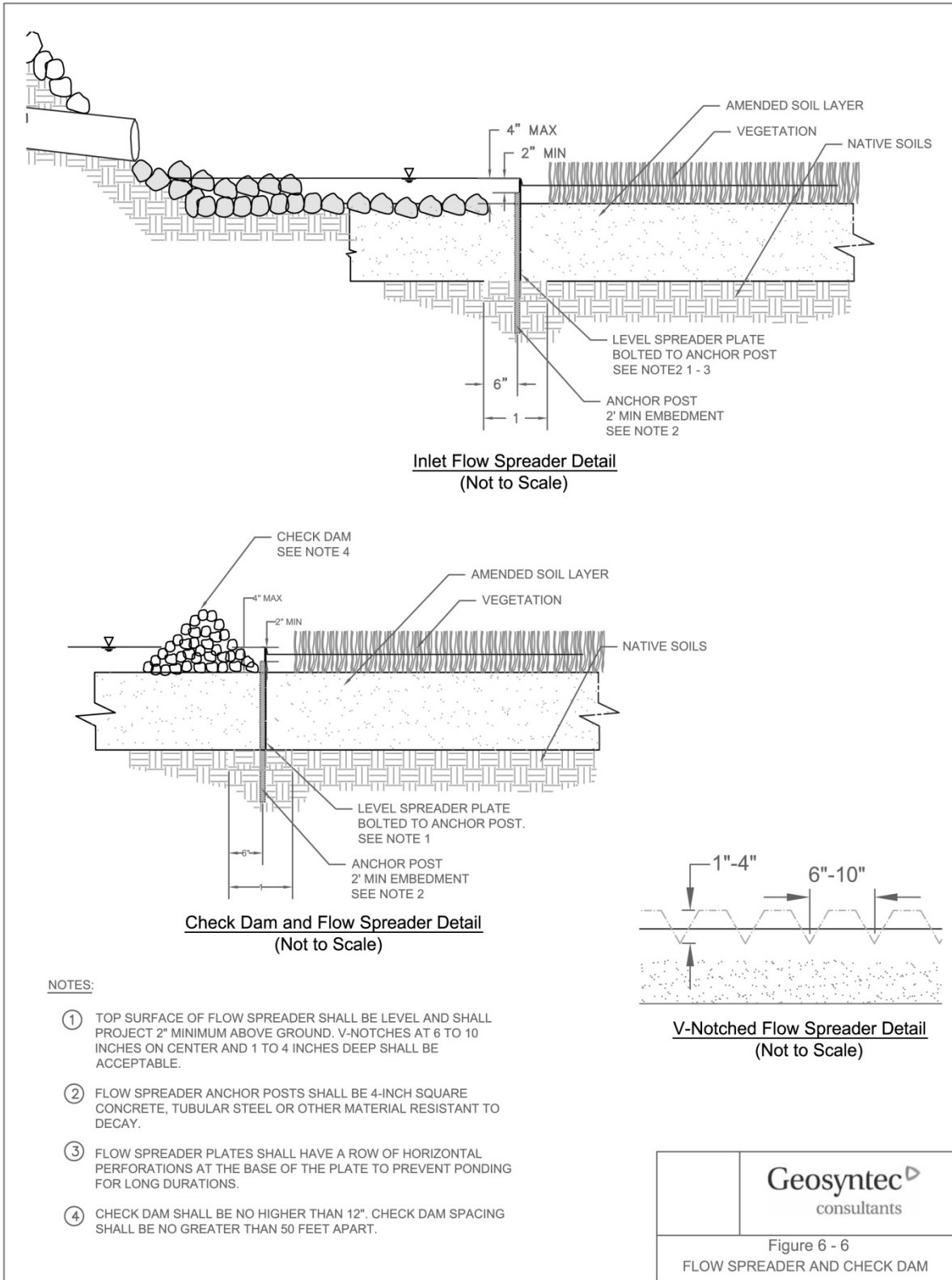

### Operations and Maintenance

#### *General Requirements*

1. Inspect vegetated swales for erosion or damage to vegetation after every storm greater than 0.75" for on-line swales and at least twice annually for off-line swales, preferably at the end of the wet season to schedule summer maintenance and in the fall to ensure readiness for winter. Additional inspection after periods of heavy runoff is recommended. Each swale shall be checked for debris and litter and areas of sediment accumulation (see Appendix H for a vegetated swale inspection and maintenance checklist).
2. Swale inlets (curb cuts or pipes) shall maintain a calm flow of water entering the swale. Remove sediment as needed at the inlet if vegetation growth is inhibited in greater than 10% of the swale or if the sediment is blocking even distribution and entry of the water. Following sediment removal activities, replanting, and/or reseeding of vegetation may be required for reestablishment.
3. Flow spreaders shall provide even dispersion of flows across the swale. Sediments and debris shall be removed from the flow spreader if blocking flows. Splash pads shall be repaired if needed to prevent erosion. Spreader level shall be checked and re-leveled if necessary. See Figure 6-6 for a schematic and design specifications for flow spreaders.
4. Side slopes shall be maintained to prevent erosion that introduces sediment into the swale. Slopes shall be stabilized and planted using appropriate erosion control measures when native soil is exposed or erosion channels are forming.
5. Swales shall drain within 48 hours of the end of a storm. If a gravel drainage layer is incorporated underneath the swale to promote infiltration, this layer shall drain within 72 hours of the end of the storm. Till the swale if compaction or clogging occurs. The perforated underdrain pipe, if present, shall be cleaned if necessary.
6. Vegetation shall be healthy and dense enough to provide filtering while protecting underlying soils from erosion:
  - Mulch shall be replenished as needed to ensure survival of vegetation.
  - Vegetation, large shrubs or trees that interfere with landscape swale operation shall be pruned.
  - Fallen leaves and debris from deciduous plant foliage shall be removed.
  - Grassy swales shall be mowed to keep grass 4" to 6" in height. Grass clippings shall be removed.
  - Invasive vegetation, such as Alligatorweed (*Alternanthera philoxeroides*), Halogeton (*Halogeton glomeratus*), Spotted Knapweed (*Centaurea maculosa*), Giant Reed (*Arundo donax*), Castor Bean (*Ricinus communis*), Perennial Pepperweed (*Lepidium latifolium*), and Yellow Starthistle (*Centaurea solstitialis*) must be removed and replaced with non-invasive species. Invasive species shall never contribute more than 25% of the vegetated area.

- Dead vegetation shall be removed if greater than 10% of area coverage or when swale function is impaired. Vegetation shall be replaced and established before the wet season to maintain cover density and control erosion where soils are exposed.
7. Check dams (if present) shall control and distribute flow across the swale. Causes for altered water flow and/or channelization shall be identified and obstructions cleared. Check dams and swale shall be repaired if damaged.
  8. The vegetated swale shall be well maintained; trash and debris, sediment, visual contamination (e.g., oils), noxious or nuisance weeds, shall all be removed.

### ***Maintenance Standards***

A summary of the routine and major maintenance activities recommended for vegetated swale filters is shown in Table 6-14. Detailed routine and major maintenance standards are listed in Table 6-15 and Table 6-16.

**Table 6-14: Vegetated Swale Filter Maintenance Quick Guide**

| <b>Inspection and Maintenance Activities Summary</b> |  |
|--|--|
| <b>Routine Maintenance</b>                           | <ul style="list-style-type: none"> <li>• Remove excess sediment as needed</li> <li>• Trash and debris removal</li> <li>• Cleaning of underdrain (where applicable) and/or unclogging outlet to eliminate standing water</li> <li>• Clean and reset flow spreaders as needed to restore original function</li> <li>• Restore sunlight access to shaded regions. Remove overhanging tree branches as needed to prevent excessive shading.</li> <li>• Remove any evidence of visual contamination from floatables such as oil and grease</li> <li>• Mow routinely to maintain ideal grass height and to suppress weeds</li> <li>• Replace non-native vegetation with native species</li> <li>• Remove sediment and debris accumulation near inlet and outlet structures</li> <li>• Stabilize/repair minor erosion and scouring with gravel</li> <li>• Photographs taken before and after maintenance is encouraged</li> </ul> |
| <b>Major Maintenance</b>                             | <ul style="list-style-type: none"> <li>• Re-grade swale bottom and reseed to mitigate ponding of water between storms or excessive erosion and scouring</li> <li>• Install or replace low flow channel using pea gravel media to better convey nuisance flows</li> <li>• Re-vegetate bare exposed portions of the swale to restore vegetation to original level of coverage</li> <li>• De-thatch grass to remove accumulated sediment and aerate compacted areas to promote infiltration</li> </ul>  |

Table 6-15: Routine Maintenance Standards - Vegetated Swale Filters

| Defect or Problem                 | Condition When Maintenance is Needed  | Results Expected and Maintenance to be Performed  | Frequency  |
|-----------------------------------|---|---|--|
| Sediment Accumulation             | Sediment depth exceeds 2 inches or covers vegetation.   | Sediment deposits shall be removed without significant disturbance of the vegetation. When finished, swale shall be level from side to side and drain freely toward outlet. There shall be no areas of standing water once inflow has ceased. | Annually prior to wet season<br><br>After major storm events (>0.75 in/24 hrs) if spot checks of some basins indicate widespread damage/ maintenance needs |
| Trash and Debris Accumulation     | Any trash and debris which exceed 5 cubic feet per 1,000 square feet (one standard garbage can).        | Trash and debris removed from swale.  |  |
| Standing Water                    | When water stands in the swale between storms and does not drain freely.                                | There shall be no areas of standing water once inflow has ceased. Outlet structures and underdrain (if installed) shall drain freely.   |  |
| Flow Spreader                     | Flow spreader uneven or clogged so that flows are not uniformly distributed through entire swale width. | Spreader leveled and cleaned such that flows are distributed evenly over entire swale width.  |  |
| Excessive Shading                 | Vegetation growth is poor because sunlight does not reach swale.  | Over-hanging limbs and brushy vegetation on side slopes are trimmed back.   |  |
| Erosion/ Scouring                 | Eroded or scoured swale bottom due to flow channelization or higher flows.                              | No erosion or scouring in swale bottom. For ruts or bare areas less than 12 inches wide, damaged areas repaired by filling with crushed gravel. Over time, the grass will have started to cover the rock.                                     |  |
| Visual contaminants and pollution | Any visual evidence of oil, gasoline, contaminants or other pollutants.                                 | No visual contaminants or pollutants present.   |  |



| Defect or Problem         | Condition When Maintenance is Needed  | Results Expected and Maintenance to be Performed  | Frequency   |
|---------------------------|---|---|---|
| Vegetation length         | When the grass becomes excessively tall (greater than 10-inches); when nuisance weeds and other vegetation starts to take over. | Vegetation trimmed or mowed and nuisance vegetation removed so that flow is not impeded. Vegetation/grass shall be trimmed/mowed to a height of 4 to 6 inches (depending on landscape requirements). Grass clippings removed. | Monthly (or as dictated by agreement between County and landscape contractor) |
| Inlet/Outlet blockage     | Inlet/outlet areas clogged with sediment and/or debris.   | Material removed so that there is no clogging or blockage in the inlet and outlet area.   |   |
| Low flow channel overflow | Nuisance flows are ponding, swale is continually wet.   | Low flow channel media is renewed to adequately convey nuisance flows.  |   |

**Table 6-16: Major Maintenance Standards - Vegetated Swale Filters**

| Defect or Problem | Condition When Maintenance is Needed  | Results Expected and Maintenance to be Performed   | Frequency  |
|-------------------|---|--|--|
| Standing Water    | When water stands in the swale between storms and does not drain freely.  | There shall be no areas of standing water once inflow has ceased. Any of the following may apply: improve grade from head to foot of swale, remove clogged check dams, add underdrains, or convert to a wet biofiltration swale. | Annual – preferably at end of wet season or as needed (infrequent)   |
| Erosion/ Scouring | Eroded or scoured swale bottom due to flow channelization, or higher flows.   | No erosion or scouring in swale bottom. If bare areas greater than 12 inches wide exist, re-grade, and re-seed.  | After major storm events (>0.75 in/24 hrs) if spot checks of some basins indicate widespread damage/ maintenance needs |
| Constant Baseflow | When small quantities of water continually flow through the swale, even when it has been dry for weeks and an eroded, muddy channel has formed in the swale bottom. | No eroded or muddy channel on the bottom. A low-flow pea-gravel drain may be added to the length of the swale, or an underdrain installed.   |  |

| Defect or Problem        | Condition When Maintenance is Needed   | Results Expected and Maintenance to be Performed   | Frequency  |
|--------------------------|--|--|--|
| Poor Vegetation Coverage | When grass is sparse or bare or eroded patches occur in more than 10% of the swale bottom. | Vegetation coverage in more than 90% of the swale bottom. Poorly vegetated areas of the swale bottom shall be re-planted with plugs of grass from the upper slope and reseeded in locations where plugs were taken. Plugs shall be planted in the swale bottom with no gaps, or re-seeded into loosened, fertile soil. | Semi annual – at beginning and end of wet season |

### 6.6.3 Vegetated Filter Strip

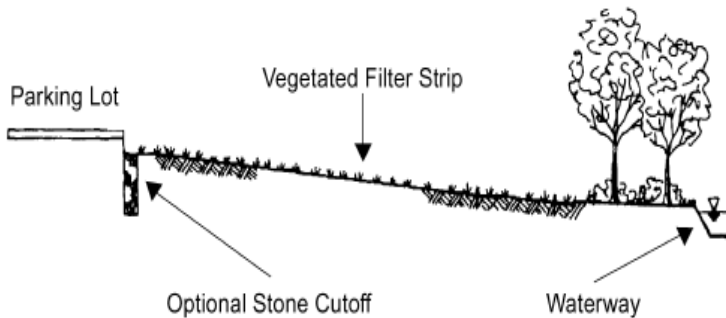

**Figure 6-7: Vegetated Filter Strip Providing Pretreatment for a Bioretention Area**

*Photo Credit: New Jersey Storm Water BMP Manual*

#### 6.6.3.1 Description

Vegetated filter strips (filter strips) are vegetated areas designed to treat sheet flow runoff from adjacent impervious surfaces or intensive landscaped areas such as golf courses. Filter strips rely on dense turf vegetation with a thick thatch, growing on a moderately permeable soil and are well suited to treat runoff from roads and highways, driveways, roof downspouts, small parking lots, and other impervious surfaces. They are also good for use as vegetated buffers between developed areas and natural drainages. These BMPs filter storm water immediately adjacent to impervious surfaces and are typically intended for pre-treatment and not as a standalone BMP. Filter strips decrease runoff velocity, filter out sediment and associated pollutants, and provide some infiltration into underlying soils. Filter strips are more effective when the runoff passes through the vegetation and thatch layer in the form of shallow, uniform "sheet flow".

#### 6.6.3.2 Applicability, Performance, and Limitations

Table 6-17, Table 6-18, and Table 6-19 provide a summary of BMP performance, applicability, and limitations for Vegetated filter strips (filter strips). *It is important to note that information in these tables shall be used to provide general guidance for Vegetated filter strips and shall not replace the evaluation performed by a water quality professional.*

##### ***Applicability and Performance***

Table 6-17 and associated guidance provide general volume reduction capabilities and treatment effectiveness for filter strips. Refer to Section 6.4 for the process that shall be used for selecting BMPs based on pollutants of concern. Refer to Table 6-1 to determine the ranking of filter strips for removal of pollutants of concern as compared with other storm water runoff BMPs provided in Chapter 6. Refer to Table 6-2 to assess the applicability of filter strips for your site based on site suitability considerations as compared with other storm water runoff BMPs provided in Chapter 6. Filter strips are flow-based BMPs intended for achieving water

#### **Applications**

- Roads and highway shoulders
- Small parking lots
- Residential, commercial, or institutional landscaping

#### **Advantages**

- Good pre-treatment BMP
- Simple, aesthetically pleasing landscaping
- Low cost/maintenance

#### **Limitations**

- Must be sited adjacent to imperviousness surfaces
- May not be suitable for industrial sites
- Requires sheet flow across vegetated area

quality treatment and, depending on site slope and soil conditions, can provide some volume reduction (See Table 6-18). Filter strips are not intended to be a primary BMP for meeting the volume reduction,  $V_{\text{reduction}}$ , or peak runoff discharge requirements; although, they do assist in increasing a site's time of concentration,  $T_c$ , and reducing storm water runoff volumes and runoff discharge rates. See Section 6.2 for specific storm water runoff requirements for Tier 3 projects.

**Table 6-17: Volume Reduction & Treatment Effectiveness for Vegetated Filter Strips**

| Storm Water Runoff BMP   | Volume Mitigation (% of inflow) | Treatment Effectiveness for Pollutants of Concern <sup>1</sup> |           |          |  |          |  |
|--|---------------------------------|--|-----------|----------|--|----------|--|
|  |                                 | Trash  | Nutrients | Bacteria | Metals (particulate and dissolved fractions) | Sediment | Organics (hydrocarbons, oil, and grease) |
| Vegetated Filter Strip   | ●                               | ◐  | ◑         | ○        | ●  | ●        | ●  |
| Volume/Treatment Effectiveness: ● = Very High, ◐ = High, ◑ = Moderate, ◒ = Low, ○ = Very Low |                                 |  |           |          |  |          |  |

<sup>1</sup> Effectiveness may change based on design variations; standard BMP designs have been assumed.

Since runoff passes through filter strip vegetation in shallow, uniform flow, some volume reduction occurs although filter strips are not designed specifically for volume reduction. While some assimilation of dissolved constituents may occur, filter strips are generally more effective in trapping sediment and particulate-bound metals, nutrients, and pesticides. Nutrients that bind to sediment include phosphorus and ammonium; soluble nutrients include nitrate. Biological and chemical processes may help break down pesticides, uptake metals, and utilize nutrients that are trapped in the filter.

### *Site Suitability Recommendations and Limitations*

Table 6-18 and associated guidance provide general considerations for assessing a site's suitability for filter strips.

**Table 6-18: Site Suitability Considerations for Vegetated Filter Strips**

| BMP                    | Tributary Area (Acres; Sq.Ft.) <sup>1</sup> | Site Slope (%)  | Depth to Seasonally High Groundwater Table (ft) | Hydrologic Soil Group | Horizontal Setback from Drinking Water Wells (ft) |
|------------------------|---|---|---|-----------------------|---|
| Vegetated Filter Strip | < 2 Acres; 87,120 Sq.Ft.                    | < 5 site slope; 2 to 6 longitudinal slope of strip <sup>2</sup> | > 2   | Any                   | N/A   |

<sup>1</sup> Tributary area is the area of the site draining to the BMP. Tributary areas provided here shall be used as a general guideline only. Tributary areas can be larger or smaller in some instances.

<sup>2</sup> If site slope exceeds that specified or if the system is within 200 ft from the top of a hazardous slope or landslide area, a geotechnical investigation is required.

Table 6-19 provides additional site suitability considerations for special design districts within the City including coastal bluff areas and hillside design districts.

**Table 6-19: Applicability of Vegetated Filter Strips for Special Design Districts**

| Coastal Bluff Area  | Hillside Design District  |
|---|---|
| Acceptable if: (1) facility is not designed to promote infiltration, (2) underdrains and an impermeable liner are provided regardless of hydrologic soil group (HSG) type, and (3) site slope meets the criteria in Table 6-18. | Acceptable if: (1) a geotechnical investigation proves that the facility does not compromise the stability of the site slope or surrounding slopes, or (2) the facility includes an impermeable liner, underdrain system, and an overflow to a storm water conveyance system, if the facility is on-line. |

The following describes additional site suitability recommendations and limitations for Vegetated filter strip.

- Limit the tributary area and associated longitudinal slope (parallel to the flow) to less than 2 acres and less than 5%, respectively, reducing the potential for high flow velocity and concentrated, erosive flows from entering the filter strip.
- Maximum length (in the direction of flow towards the filter strip) of the tributary area shall be 150 feet.
- The lateral slope of the contributing area (parallel to the edge of the pavement) shall be 4% or less.
- The longitudinal slope over the length of the filter strip can be up to 6% before concentrated, erosive flows become potentially problematic.
- Mild longitudinal slope (< 2%) over the length of the filter strip can cause ponding.
- The use of filter strips is limited to areas where the vegetative cover is robust and diffuse, and where shallow flow characteristics are possible.
- Sheet flow - shallow, evenly-distributed flow across entire width of strip is required. Level slopes perpendicular to the direction of flow are required to achieve sheet flow.
- A uniformly graded thick vegetative cover is required to function properly.
- Availability of pervious area adjacent to impervious area – filter strips require sheet flow from impervious areas. Impractical in highly urban areas with little pervious ground.
- The filter strip shall be located away from building or excessive tree shadows to avoid poor plant growth.

- Groundwater levels shall be at least 2 ft lower than the strip surface to ensure that the filter strip does not remain wet between storms.
- May not be applicable adjacent to industrial sites or locations where spills may occur.
- Cannot be applied in areas with highly erodible soils.
- Avoid areas that are highly trafficked, both by automobiles and people.

### ***Multi-Use and Treatment Train Opportunities***

Filter strips are often used as pre-treatment devices for other larger capacity BMPs such as bioretention areas and assist by filtering sediment and associated pollutants prior to entering the larger capacity BMP preventing clogging and reducing the maintenance requirements for larger capacity BMPs. Filter strips provide an attractive and inexpensive vegetative storm water runoff BMP that can be easily incorporated into the landscape design of a site. Filter strips are commonly used in the landscape designs of residential, commercial, industrial, institutional, and roadway applications. They shall be located adjacent to the impervious areas that they are intended to treat.

#### **6.6.3.3 Design Criteria and Procedure**

The main challenge associated with filter strips is maintaining sheet flow, which is critical to performance of this BMP. If flows are concentrated, then little or no treatment of storm water runoff is achieved and erosive rilling is likely. The use of a flow spreading device (e.g., gravel trench or level spreader) to deliver shallow, evenly-distributed sheet flow to the strip is required. Principal design criteria for filter strips are listed in Table 6-20. A filter strip is illustrated schematically in Figure 6-8. A flow spreader device is illustrated schematically in Figure 6-6.

**Table 6-20: Vegetated Filter Strip Design Criteria**

| Design Parameter                                | Unit    | Design Criteria   |
|---|---------|---|
| Water quality design flow rate, $Q_{wq}$        | cfs     | Runoff produced from a 0.25 in/hr design rainfall intensity of at least four hour duration. See Section 6.2 and Appendix C for calculating the water quality design flow rate, $Q_{wq}$ . |
| Minimum design flow depth                       | inches  | 1   |
| Design residence time                           | minutes | 10  |
| Design flow velocity                            | ft/sec  | < 1 ft/sec  |
| Minimum width (perpendicular to flow direction) | feet    | Equal to width of tributary area  |
| Minimum length in flow direction                | feet    | 15 (25 preferred); if sized for pretreatment only, filter strip can be a minimum of 4.  |
| Maximum length in flow direction                | feet    | 150   |
| Maximum slope in flow direction                 | %       | 6   |

| Design Parameter                | Unit   | Design Criteria                               |
|---------------------------------|--------|---|
| Minimum slope in flow direction | %      | 2   |
| Maximum lateral slope           | %      | 4   |
| Vegetation                      | -      | Turf grass (irrigated) or approved equal      |
| Minimum grass height            | inches | 2   |
| Maximum grass height            | inches | 4 (typical) or as required to prevent shading |
| Elevation of flow spreader      | inches | > 1 inch below the pavement surface           |

### ***Geometry and Size***

1. The width of the filter strip shall extend across the full width of the tributary area. The upstream boundary of the filter shall be located contiguous to the developed area.
2. If the filter strip is used to meet the water quality treatment requirements, the length (in direction of flow) shall be between 15 and 150 feet. A minimum length of 25 feet is preferred. Filter strips used for pretreatment shall be at least 4 feet long (in direction of flow).
3. Filter strips shall be designed on slopes (parallel to the direction of flow) between 2% and 6%; steeper slopes tend to result in concentrated flow. Slopes less than 2% could pond runoff, and in poorly permeable soils, create a mosquito breeding habitat.
4. The lateral slope of strip (parallel to the edge of the pavement, perpendicular to the direction of flow) shall be 4% or less.
5. Grading shall be even: a filter strip with uneven grading perpendicular to the flow path will develop flow channels over time.
6. The top of the strip shall be installed 2 to 5 inches below the adjacent pavement to allow for vegetation and sediment accumulation at the edge of the strip. A beveled transition is acceptable and may be required per roadside design specifications.
7. Both the top and toe of the slope shall be as flat as possible to encourage sheet flow and prevent channeling and erosion. For engineered filter strips, the facility surface shall be graded flat prior to placement of vegetation.

### ***Sizing Methodology***

The flow capacity of a Vegetated filter strips (filter strips) is a function of the longitudinal slope (parallel to flow), the resistance to flow (e.g., Manning's roughness), and the width and length of the filter strip. The slope shall be small enough to ensure that the depth of water will not exceed 1 inch over the filter strip. Similarly, the flow velocity shall be less than 1 ft/sec. Procedures for sizing filter strips are summarized below. A filter strip sizing example is provided in Appendix D.

Step 1: Calculate the design flow rate

The design flow is calculated based on the water quality design flow rate,  $Q_{wq}$ , as described in Section 6.2 and Appendix C.

Step 2: Calculate the design flow depth

The design flow depth ( $d$ ) is calculated based on the width and the slope (parallel to the flow path) using a modified Manning's equation as follows:

$$d = [Q_{wq} n_{wq} / 1.49ws^{0.5}]^{0.6} \quad (\text{Equation 6-14})$$

Where:

- $d$  = design flow depth (ft)
- $Q_{wq}$  = water quality design flow rate (cfs)
- $w$  = width of strip perpendicular to flow which equals the width of impervious surface contributing to the filter strip (ft)
- $s$  = slope (ft/ft) of strip parallel to flow, average over the whole width
- $n_{wq}$  = Manning's roughness coefficient (0.25-0.3)

If  $d$  is greater than 1 inch, then a smaller slope is required, or a filter strip cannot be used.

Step 3: Calculate the design velocity

The design flow velocity is based on the design flow, design flow depth, and width of the strip:

$$v_{wq} = Q_{wq} / dw \quad (\text{Equation 6-15})$$

Where:

- $v_{wq}$  = water quality design flow velocity (ft/sec)
- $Q_{wq}$  = water quality design flow rate (cfs)
- $d$  = design flow depth (ft)
- $w$  = width of strip perpendicular to flow which equals the width of impervious surface contributing to the filter strip (ft)

Step 4: Calculate the desired length of the filter strip

Determine the required length ( $L$ ) to achieve a desired residence time of 10 minutes using:

$$L = 600v_{wq} \quad (\text{Equation 6-16})$$

Where:

- $L$  = swale length (ft)
- $v_{wq}$  = design water quality flow velocity (ft/sec)



If the filter strip is being sized to meet the water quality treatment requirement, the filter strip length shall be between 15 and 150 feet (with a minimum of 25 preferred). If the filter strip is designed for pretreatment, the minimum length shall be 4 feet. Therefore, if the length is calculated to be outside of this desired range and other design parameters cannot be altered to achieve the desired length, alternative BMPs, such as a vegetated swale filters, may be considered more appropriate.

### ***Energy Dissipation / Level Spreading***

Runoff entering a filter strip must not be concentrated. A flow spreader shall be installed at the edge of the pavement to uniformly distribute the flow along the entire width of the filter strip.

1. At a minimum, a gravel flow spreader (gravel-filled trench) shall be placed between the impervious area contributing flows and the filter strip, and meet the following requirements:
  - a. The gravel flow spreader shall be a minimum of 6 inches deep and shall be 12 inches wide.
  - b. The gravel shall be a minimum of 1 inch below the pavement surface. Intent: This allows sediment from the paved surface to be accommodated without blocking drainage onto the strip.
  - c. Where the ground surface is not level, the gravel spreader must be installed so that the bottom of the gravel trench and the outlet lip are level.
  - d. Along roadways, gravel flow spreaders must be placed and designed in accordance with County road design specifications for compacted road shoulders.
2. A notched curb spreader and through-curb port spreader may only be used in conjunction with a gravel spreader to better ensure that water sheet flows onto the strip, provided:
  - a. Curb ports use fabricated openings that allow concrete curbing to be poured or extruded while still providing an opening through the curb to admit water to the filter strip. Openings in the curb shall be at regular intervals but at least every 6 feet. The width of each curb port opening shall be a minimum of 11 inches. Approximately 15 percent or more of the curb section length shall be in open ports, and no port shall discharge more than about 10 percent of the flow.
  - b. Interrupted curbs are sections of curb placed to have gaps spaced at regular intervals along the total width of the treatment area. At a minimum, gaps shall be every 6 feet to allow distribution of flows into the treatment facility before they become too concentrated. The opening shall be a minimum of 11 inches. As a general rule, no opening shall discharge more than 10 percent of the overall flow entering the facility.
3. Energy dissipaters are needed in a filter strips if sudden slope drops occur, such as locations where flows in a filter strip pass over a rockery or retaining wall aligned perpendicular to the direction of flow. Adequate energy dissipation at the base of a drop section can be provided by a riprap pad.

***Access***

1. Access shall be provided at the upper edge of a filter strip to enable maintenance of the inflow spreader throughout the strip width and allow access for mowing equipment.

***Water Depth and Velocity***

1. The design water depth shall not exceed 1 inch.
2. Runoff flow velocities shall not exceed approximately 1 foot per second across the filter strip surface.

***Soils***

1. Filter strip soils shall be amended with 2 inches of well-rotted compost, unless the organic content is already greater than 10%. The compost shall be mixed into the native soils to a depth of 6 inches to prevent soil layering and washout of compost. The compost will contain no sawdust, green or under-composted material, or any other toxic or harmful substance. It shall contain no un-sterilized manure which can lead to high levels of potentially pathogenic bacteria in the runoff. See Section 5.10 for more guidance on soil amendments.

***Vegetation***

Filter strips must be uniformly graded and densely vegetated with erosion-resistant grasses that effectively bind the soil. Native or adapted grasses are preferred because they generally require less fertilizer and are more drought resistant than exotic plants. The following vegetation guidelines shall be followed for filter strips:

1. Sod (turf) can be used instead of grass seed, as long as there is complete coverage.
2. Irrigation shall be provided to establish the grasses.
3. Grasses or turf shall be maintained at a height of 2 to 4 inches. Regular mowing is often required to maintain the turf grass cover.
4. Trees or shrubs shall not be used in abundance because they shade the turf and impede sheet flow.
5. See Appendix G for a recommended native plant list for Vegetated filter strips, a list of local nurseries where these plants can be purchased, and a list of local and regional on-line resources. The plant list in Appendix G shall be used as a guide only and shall not replace project-specific planting recommendations provided by a landscape professional including recommendations on appropriate plants, fertilizer, mulching applications, and irrigation requirements (if any) to ensure healthy vegetation growth. See Section 5.11 for more information on landscaping/planting recommendations and Section 5.10 for more information on soil amendment recommendations.

**6.6.3.4 Construction Considerations**

The use of treated wood or galvanized metal anywhere inside the facility is prohibited.

**Figure 6-8: Vegetated Filter Strip Schematic**

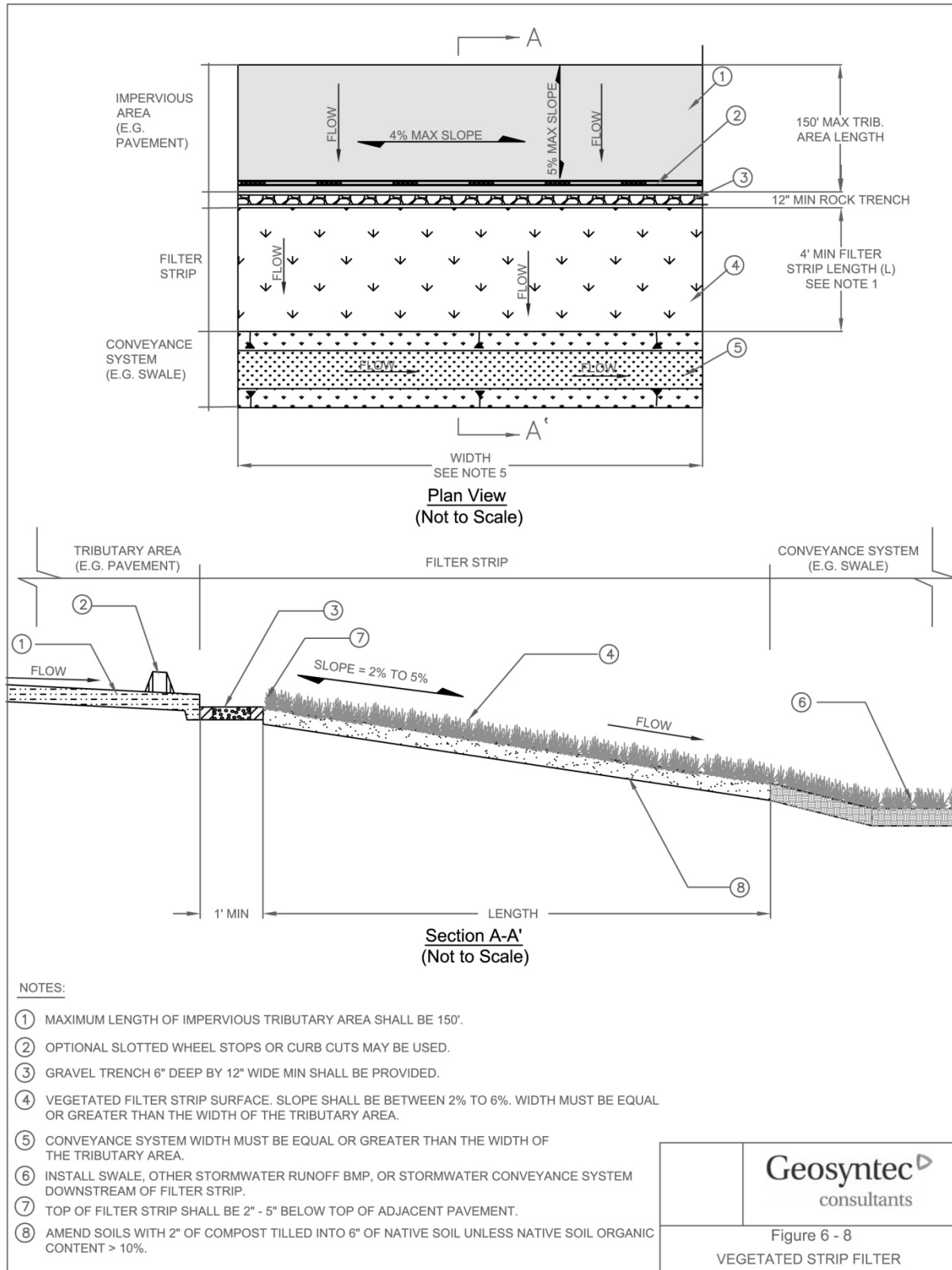

### 6.6.3.5 Operations and Maintenance

#### *General Requirements*

Vegetated filter strips (filter strips) mainly require vegetation management; therefore little special training is needed for maintenance crews. Typical maintenance activities and frequencies include:

1. Inspect filter strips at least twice annually for erosion or damage to vegetation, preferably at the end of the wet season to schedule summer maintenance and in the fall to ensure the filter strip is ready for winter. However, additional inspection after periods of heavy runoff is most desirable. The strip shall be checked for debris and litter and areas of sediment accumulation (see Appendix H for vegetated filter strip inspection and maintenance checklist).
2. Mow as frequently as necessary (at least twice a year) for safety and aesthetics or to suppress weeds and woody vegetation.
3. Trash tends to accumulate in strip areas, particularly along roadways. The need for litter removal shall be determined through periodic inspection. Litter shall always be removed prior to mowing.
4. Regularly inspect vegetated buffer strips for pools of standing water. Filter strips can become a nuisance due to mosquito breeding in level spreaders (unless designed to dewater completely in less than 72 hours), in pools of standing water if obstructions develop (e.g., debris accumulation, invasive vegetation), and/or if proper drainage slopes are not implemented and maintained.
5. Activities that lead to ruts or depressions on the surface of the filter strip shall be prevented or the integrity of the strip shall be restored by leveling and reseeded. Examples are vehicle tracks, utility maintenance, and pedestrian (short-cut) tracks.

#### *Maintenance Standards*

A summary of the routine and major maintenance activities recommended for Vegetated filter strips is shown in Table 6-21. Detailed routine and major maintenance standards are listed in Table 6-22 and Table 6-23.

**Table 6-21: Vegetated Filter Strip Maintenance Quick Guide**

| <b>Inspection and Maintenance Activities Summary</b> |   |
|--|---|
| <b>Routine Maintenance</b>                           | <ul style="list-style-type: none"> <li>• Remove excess sediment as needed</li> <li>• Stabilize/repair minor erosion and scouring with crushed gravel</li> <li>• Remove trash and debris</li> <li>• Remove any evidence of visual contamination from floatables such as oil and grease</li> <li>• Mow routinely to maintain ideal grass height and to suppress weeds</li> <li>• Irrigate as necessary to maintain healthy grass cover</li> <li>• Remove non-native vegetation and re-vegetate with native species</li> <li>• Photographs taken before and after maintenance is encouraged</li> </ul> |
| <b>Major Maintenance</b>                             | <ul style="list-style-type: none"> <li>• Regrade and revegetate to repair damage from severe erosion/scour channelization and to restore sheet flow</li> <li>• Clean and reset flow spreaders as needed to restore original function</li> </ul>   |

Table 6-22: Routine Maintenance – Vegetated Filter Strips

| Defect                            | Conditions When Maintenance Is Needed   | Results Expected When Maintenance Is Performed   | Frequency  |
|-----------------------------------|---|--|--|
| Sediment Accumulation             | Sediment depth exceeds 2 inches or covers vegetation.   | Sediment deposits removed and surface re-leveled in order to maintain sheet flow over the filter strip.  | Semi-annually, prior to wet season and after the wet season<br><br>After major storm events (>0.75 in/24 hrs) if spot checks indicate widespread damage/ maintenance needs |
| Erosion/Scouring                  | Eroded or scoured areas due to flow channelization, or higher flows.  | No erosion or scouring evident. For ruts or bare areas less than 12 inches wide, damaged areas repaired by filling with crushed gravel. The grass will creep in over the rock in time.   |  |
| Flow spreader clogged/uneven      | Flow spreader uneven or clogged so that flows are not uniformly distributed through entire filter width.                        | Spreader leveled and cleaned so that flows are spread evenly over entire filter width.   |  |
| Visual contaminants and pollution | Any visual evidence of oil, gasoline, contaminants or other pollutants.   | No visual contaminants or pollutants present.  |  |
| Aesthetics                        | Minor vegetation removal and thinning. Mowing berms and surroundings  | Facility is well kept.   | Semi-annually (or as dictated by agreement between County and landscape contractor)  |
| Vegetation length, nuisance weeds | When the grass becomes excessively tall (greater than 10-inches); when nuisance weeds and other vegetation starts to take over. | Grass mowed, nuisance vegetation controlled, such that flow is not impeded. Grass mowed to a height between 2-4 inches and clippings removed.  |  |
| Trash and Debris Accumulation     | Trash and debris accumulated on the filter strip.   | Trash and debris removed from filter strip and flow spreading devices.   |  |
| Noxious Weeds                     | Any evidence of noxious weeds.  | All noxious weeds eradicated and future establishment controlled with use of Integrated Pest Management (IPM) techniques, if applicable. See <a href="http://www.ipm.ucdavis.edu">http://www.ipm.ucdavis.edu</a> for more information. | Litter removal and mowing frequency is dependent on site conditions and desired aesthetics and shall be done at a frequency to meet those objectives                       |

**Table 6-23: Major Maintenance – Vegetated Filter Strip**

| Defect           | Conditions When Maintenance Is Needed | Results Expected When Maintenance Is Performed   | Frequency |
|------------------|---------------------------------------|--|-----------|
| Erosion/Scouring | Bare spots greater than 12 inches     | No erosion visible. Large, bare areas greater than 12 inches wide re-graded and re-seeded. | As needed |



### 6.6.4 Sand Filter



**Figure 6-9: Volleyball Court Sand Filter**

#### 6.6.4.1 Description

A sand filter operates much like a bioretention area; however, instead of filtering storm water through planting soils, storm water is filtered through a constructed sand bed with an underdrain system. Runoff enters the filter and spreads over the surface. As flows increase, water backs up on the surface of the filter where it is held until it can percolate through the sand. The treatment pathway is vertical (downward through the sand). High flows in excess of the design volume simply spill out over the top of the pool or over a designed spillway. Water that has percolated through the sand is collected via a perforated underdrain system before being conveyed to the downstream storm drainage system. As storm water passes through the sand, pollutants are trapped in the small pore spaces between sand grains or are adsorbed to the sand surface. Over time, bacteria can grow in the sand bed and provide some biological treatment. However, continuous dry weather flows would be required to maintain the moisture required by the bacteria.

Because they have few site constraints besides head requirements, sand filters can be used on development sites where the use of other structural controls may be precluded. However, sand filter systems can be relatively expensive to construct and install.

There are three general sand filter designs:

1. **Surface Sand Filter** – the surface sand filter is a ground-level open air structure that consists of pretreatment (e.g., vegetated BMP, proprietary device, or sediment forebay) and a filter bed chamber with perforated drain pipe under the filter bed that diverts filtered flows to another BMP type, storm water conveyance system, or is daylighted and dispersed over a pervious area. This system can treat drainage areas up to 10 acres in

#### Applications

- Roads, highways, parking lots
- Commercial and industrial
- Roof runoff
- Golf courses and open spaces

#### Advantages

- Efficient removal of pollutants
- Good retrofit capability
- Good for highly impervious areas

#### Limitations

- High maintenance burden
- Not recommended for runoff with high sediment content
- Usually little volume reduction
- Relatively costly

size and is typically located off-line. Surface sand filters can be designed as an excavation with earth embankments or as a concrete or block structure.

2. **Perimeter Sand Filter** – The perimeter sand filter is an enclosed filter system typically constructed just below grade in a vault along the edge of an impervious area such as a parking lot. The system consists of a sedimentation (pretreatment) chamber and a sand bed filter. Runoff flows into the structure through a series of inlet grates located along the top of the control. Perforated drain pipes under the sand filter bed divert flows to another BMP type, storm water conveyance system, or are daylighted and dispersed over a pervious area.
3. **Underground Sand Filter** – The underground sand filter is primarily for extremely space limited and high density areas and consists of a three-chamber system. The initial chamber is a sedimentation (pretreatment) chamber that temporarily stores runoff and utilizes a wet pool to capture sediment. The sedimentation chamber is connected to the sand filter chamber by a submerged wall that protects the filter bed from oil and trash. Perforated drain pipes under the sand filter bed extend into the third chamber that collects filtered runoff. Flows beyond the filter capacity are diverted through an overflow weir, which carries flow to another BMP type, the storm water conveyance system, or is daylighted and dispersed over a pervious area.

#### 6.6.4.2 Performance, Applicability, and Limitations

Table 6-24, Table 6-25, and Table 6-26 provide a summary of BMP performance, applicability, and limitations for sand filters. *It is important to note that information in these tables shall be used to provide general guidance for sand filters and shall not replace the evaluation performed by a water quality professional.*

#### ***Applicability and Performance***

Table 6-24 and associated guidance provide general volume reduction capabilities and treatment effectiveness for sand filters. Refer to Section 6.4 for the process that shall be used for selecting BMPs based on pollutants of concern. Refer to Table 6-1 to determine the ranking of sand filters for removal of pollutants of concern as compared with other storm water runoff BMPs provided in Chapter 6. Refer to Table 6-2 to assess the applicability of sand filters for your site based on site suitability considerations as compared with other storm water runoff BMPs provided in Chapter 6. Sand filters are volume-based BMPs intended, primarily, for treating the water quality design volume,  $V_{wq}$  (See Table 6-24). In most cases, sand filters are enclosed concrete or block structures with underdrains; therefore, only minimal volume reduction occurs via evaporation as storm water percolates through the filter to the underdrain. Hybrid sand filters combined with dry extended detention basins (as described in Section 6.10.3), can be designed with or without underdrains and utilize the sand filter as a filtration and storage layer allowing storm water to be detained and filtered (if underdrains are included) or, if site conditions allow, infiltrated into the subsoil (if underdrains are omitted). In this hybrid case, volume reduction can be achieved. With the exception of sand filters that allow for significant infiltration, sand filters are generally not intended to be used to meet the peak runoff discharge requirement. See Section 6.2 for specific storm water runoff requirements for Tier 3 projects.

**Table 6-24: Volume Reduction & Treatment Effectiveness for Sand Filters**

| Storm Water Runoff BMP   | Volume Mitigation (% of inflow) | Treatment Effectiveness for Pollutants of Concern <sup>1</sup> |           |          |  |          |  |
|--|---------------------------------|--|-----------|----------|--|----------|--|
|  |                                 | Trash  | Nutrients | Bacteria | Metals (particulate and dissolved fractions) | Sediment | Organics (hydrocarbons, oil, and grease) |
| Sand Filter  | ●                               | ○  | ●         | ●        | ◐  | ◐        | ◐  |
| Volume/Treatment Effectiveness: ● = Very High, ◐ = High, ◑ = Moderate, ◒ = Low, ○ = Very Low |                                 |  |           |          |  |          |  |

<sup>1</sup> Effectiveness may change based on design variations; standard BMP designs have been assumed.

Pollutants including metals, phosphorus, and pesticides are generally trapped in the small pore spaces between sand grains or are adsorbed to the sand surface within the filter.

**Site Suitability Recommendations and Limitations**

Table 6-25 and associated guidance provide general considerations for assessing a site's suitability for sand filters.

**Table 6-25: Site Suitability Considerations for Sand Filters**

| BMP         | Tributary Area (Acres) <sup>1</sup> | Site Slope (%)    | Depth to Seasonally High Groundwater Table (ft) | Hydrologic Soil Group | Horizontal Setback from Drinking Water Wells (ft) |
|-------------|-------------------------------------|-------------------|---|-----------------------|---|
| Sand Filter | < 10                                | < 15 <sup>2</sup> | > 2 with underdrains; > 5 without underdrains   | Any                   | 100 <sup>3</sup>                                  |

<sup>1</sup> Tributary area is the area of the site draining to the BMP. Tributary areas provided here shall be used as a general guideline only. Tributary areas can be larger or smaller in some instances.

<sup>2</sup> If system is fully contained and includes a liner, underdrain system, and overflow to a storm drain system, then slopes can exceed 15%.

<sup>3</sup> Setbacks apply to systems without underdrains or systems underlain by "A" or "B" hydrologic soil groups.

Table 6-26 provides additional site applicability considerations for special design districts within the City including coastal bluff areas and hillside design districts.

**Table 6-26: Applicability of Sand Filters for Special Design Districts**

| Coastal Bluff Area  | Hillside Design District  |
|---|---|
| Acceptable if: (1) facility is not designed to promote infiltration, (2) underdrains and an impermeable liner are provided regardless of hydrologic soil group (HSG) type, and (3) site slope meets the criteria in Table 6-25. | Acceptable if: (1) a geotechnical investigation proves that the facility does not compromise the stability of the site slope or surrounding slopes, or (2) the facility includes an impermeable liner, underdrain system, and an overflow to a storm water conveyance system, if the facility is on-line. |

The following section provides additional site suitability recommendations and limitations for sand filters.

- Limit the tributary area and site slope to less than 10 acres and less than 15%, respectively; these criteria reduce the potential for high flow velocity and concentrated, erosive flows from entering the sand filter.
- If designed with underdrains and an impermeable interface between the sand filter bed and the subsoil (e.g., concrete or block structure), depth to seasonally high groundwater table shall be at least 2 feet and there is no setback requirement from drinking water wells.
- If designed for infiltration (i.e., without underdrains), depth to seasonally high groundwater table shall be at least 5 feet and the horizontal setback from drinking water wells shall be 100 feet.
- The sand filter shall be located away from trees producing leaf litter or areas contributing significant eroded sediment to prevent clogging.
- If used in hot spot areas (e.g., industrial sites, gas stations), and underdrain and impermeable interface between the sand filter bed and the subsoil (e.g., concrete or block structure) is required to protect from infiltration into the subsoil.
- Sand filters shall be placed off-line to prevent scouring of the filter bed by high flows. The overflow structure must be designed to pass the water quality design flow rate,  $Q_{wq}$ .
- Sand filters are generally not recommended to treat runoff with high sediment concentrations which may clog the filter; pretreatment is essential. In addition, high loading rates may also cause premature clogging of the filter.
- Site must have adequate relief between land surface and storm water conveyance system to permit vertical percolation through the sand filter and collection and conveyance in the perforated underdrain to storm water conveyance system; four feet of elevation difference is recommended between the inlet and outlet of the filter.

### ***Multi-Use and Treatment Train Opportunities***

Sand filters are generally not suitable for multi-use. However, some innovative designs are possible, such as combining a sand filter with a dry extended detention basin (see Section 6.10.3) or incorporating a sand filter into a volleyball court. Both of these applications can encourage infiltration if site conditions allow and require significant pretreatment to remove coarse solids, trash and debris, and oil and grease. Recreational multi-use facilities must be inspected after every storm and may require a greater maintenance frequency than dedicated sand filters as to ensure aesthetics and public safety are not compromised. Effluent from a sand filter may also be routed to another storm water runoff BMP to form a “treatment train” that can provide enhanced water quality treatment and reductions in runoff volume and rate to meet the storm water runoff requirements as outlined in Section 6.2.

### 6.6.4.3 Design Criteria and Procedure

The main challenge associated with sand filters is maintaining its filtration capacity, which is critical to performance of this BMP. If flows entering the sand filter are high and have high sediment concentrations, erosion and clogging of the sand filter are likely. Contribution of eroded soils or leaf litter may also reduce the infiltration and associated treatment capacity of the structure. A schematic of a surface sand filter is illustrated in Figure 6-10.

Principal design criteria for sand filters are listed in Table 6-27.

**Table 6-27: Sand Filter Design Criteria**

| Design Parameter                      | Unit            | Design Criteria  |
|---------------------------------------|-----------------|--|
| Water quality design volume, $V_{wq}$ | ft <sup>3</sup> | See Section 6.2.3 and Appendix C for calculating the water quality design volume, $V_{wq}$ |
| Length to width ratio                 | L:W             | 1.5:1  |
| Filter bed depth                      | inches          | 24; 36 preferred   |
| Max ponding depth above filter bed    | feet            | 6  |
| Hydraulic conductivity of sand, $k$   | in/hr           | 1 (equal to 2 ft/day)  |
| Underdrains                           | -               | 6 inch minimum diameter; 0.5% minimum slope  |
| Side slopes                           | H:V             | 4:1 (H:V) Interior and 2:1 (H:V) Exterior  |

#### *Pretreatment*

Pretreatment must be provided for sand filters in order to reduce the sediment load entering the filter. Pretreatment refers to design features that provide settling of large particles before runoff reaches a management practice, easing the long-term maintenance burden. To ensure that pretreatment mechanisms are effective, designers shall incorporate a pretreatment BMP such as vegetated storm water runoff BMP, proprietary device, or sedimentation forebay. Examples of vegetated storm water runoff BMPs and proprietary BMPs that maybe appropriate include:

- Vegetated filter strips (See Section 6.6.3)
- Vegetated swale filters (See Section 6.6.2)
- Hydrodynamic separators (See Section 6.11 – Proprietary Devices)

#### *Sizing and Geometry*

1. Sand filters shall be sized to capture and filter the water quality design volume,  $V_{wq}$  (see Section 6.2.3 and Appendix C for further detail).
2. Sand filters may be designed in any geometric configuration, but rectangular with a 1.5:1 length-to-width ratio or greater is preferred.
3. Filter bed depth must be at least 24 inches, but 36 inches is preferred.
4. Depth of water storage over the filter bed shall be 6 feet maximum.

5. Sand filters shall be placed off-line to prevent scouring of the filter bed by high flows. The overflow structure must be designed to pass the water quality design storm.

### ***Sizing Methodology of the Sand Filter Bed***

A sand filter is volume-based BMP designed with two parts: (1) a temporary storage reservoir to store runoff, and (2) a sand filter bed through which the stored runoff must percolate. Usually the storage reservoir is simply placed directly above the filter, and the floor of the reservoir pond is the top of the sand filter bed. For this case, the storage volume also determines the hydraulic head over the filter surface, which increases the rate of flow through the sand.

Two methods are available for sizing sand filters: a simple method and a routing modeling method. The simple method uses standard values to define filter hydraulic characteristics for determining the sand surface area. This method is useful for planning purposes, for a first approximation to begin iterations in the detailed method, or when use of the detailed computer model is not desired or not available. The simple method very often results in a larger filter than the routing method. For the routing modeling method, refer to Section 6.6.1 – Bioretention Areas. A sand filter design example using the simple method is provided in Appendix D.

### **Background**

Sand filter design is based on Darcy's law:

$$Q_{wq} = kiA \quad \text{(Equation 6-17)}$$

Where:

- $Q_{wq}$  = the water quality design flow,  $Q_{wq}$  (cfs)
- $k$  = hydraulic conductivity of filter bed (ft/sec)
- $A$  = surface area perpendicular to the direction of flow (ft<sup>2</sup>)
- $i$  = hydraulic gradient (ft/ft) for a constant head and constant media depth, computed as follows:

$$i = \frac{h+l}{l} \quad \text{(Equation 6-18)}$$

Where:

- $h$  = average depth of water above the filter bed (ft), defined for this design as  $d/2$
- $d$  = maximum storage depth above the filter bed (ft)
- $l$  = thickness of filter bed (ft)

Darcy's law underlies both the simple and the routing methods of design. The filtration rate  $\nu$  (ft/sec), or more correctly,  $1/\nu$ , is the direct input in the sand filter design. The relationship between the filtration rate  $\nu$  and hydraulic conductivity,  $k$ , is revealed by equating Darcy's law and the equation of continuity,  $Q = \nu A$ . Specifically:

$$Q = kiA \quad \text{and} \quad Q = vA \quad \text{So,} \quad vA = kiA \quad \text{or:}$$

$$v = ki \quad \text{(Equation 6-19)}$$

Note that  $v \neq k$  – that is, the filtration rate is not the same as the hydraulic conductivity, but they do have the same units (distance per time).  $k$  can be equated to  $v$  by dividing  $v$  by the hydraulic gradient  $i$ , which is defined above.

The hydraulic conductivity,  $k$ , does not change with head nor is it dependent on the thickness of the media; it is only dependent on the characteristics of the media and the fluid. A hydraulic conductivity of 1 inch per hour is used to design the sand filter and is based on bench-scale tests of conditioned rather than clean sand (KCSWDM, 2005). This design hydraulic conductivity represents the average sand bed condition as silt is captured and held in the sand bed.

Unlike the hydraulic conductivity, the filtration rate,  $v$ , changes with head and media thickness, although the media thickness is constant in the sand filter design.

### Simple Sizing Method

The simple sizing method does not route flows through the filter. It determines the size of the filter based on the simple assumption that inflow is immediately discharged through the filter as if there were no storage volume. An adjustment factor (0.7) is applied to compensate for the greater filter size resulting from this method. Even with the adjustment factor, the simple method generally produces a larger filter size than the routing method.

#### Step 1: Calculate storage depth

Determine the maximum water storage depth,  $d$ , above the sand filter. This depth is defined as the depth at which water begins to overflow the temporary storage reservoir, and it depends on the site topography and hydraulic constraints. The depth is chosen by the designer, but shall be 6 feet or less.

#### Step 2: Calculate the design volume

Determine water quality design volume,  $V_{wq}$  (see Section 6.2.3 and Appendix C).

#### Step 3: Calculate the sand filter area

Determine the sand filter area,  $A_{sf}$ , using the following equation (based on Darcy's law):

$$A_{sf} = \frac{V_{wq}RL}{k_{design}t(h + L)} \quad \text{(Equation 6-20)}$$

Where:

- $A_{sf}$  = surface area of the sand filter bed (ft<sup>2</sup>)
- $V_{wq}$  = water quality design volume (ft<sup>3</sup>)
- $R$  = routing adjustment factor (use  $R = 0.7$ )

- $L$  = sand bed depth (ft)  
 $k_{design}$  = design hydraulic conductivity (use 2 ft/day which is equal to 1 in/hr)  
 $t$  = drawdown time (use 1 day)  
 $h$  = average depth of water above the filter (ft), (use  $d/2$  with  $d$  determined from Step 1)

### ***Sand Specification***

Ideally the effective diameter of the sand,  $d_{10}$ , shall be just small enough to ensure a good quality effluent while preventing penetration of storm water particles to such a depth that they cannot be removed by surface scraping (~2-3 inches). This effective diameter usually lies in the range 0.20-0.35 mm. In addition, the coefficient of uniformity,  $C_u = d_{60}/d_{10}$ , shall be less than 3.

The sand in a filter shall consist of a medium sand with very little fines meeting ASTM C 33 size gradation (by weight) or equivalent as given in the table below.

| U.S. Sieve Size | Percent Passing |
|-----------------|-----------------|
| 3/8 inch        | 100             |
| U.S. No. 4      | 95 to 100       |
| U.S. No. 8      | 80 to 100       |
| U.S. No. 16     | 50 to 85        |

### ***Underdrains***

1. Several underdrain systems can be used in a sand filter design:
  - a. Central underdrain collection pipe with lateral collection pipes in an 8 inch minimum gravel backfill or drain rock bed.
  - b. Longitudinal pipes in an 8 inch minimum gravel backfill or drain rock bed, with a collection pipe at the outfall.
  - c. Small sand filters may utilize a single underdrain pipe in an 8 inch minimum gravel backfill or drain rock bed.
2. All underdrain pipes and connectors must be 6 inches or greater so they can be cleaned without damage to the pipe. Clean-out risers with diameters equal to the underdrain pipe must be placed at the terminal ends of all pipes and extend to the surface of the filter. A valve box shall be provided for access to the cleanouts and the cleanout assembly must be water tight to prevent short circuiting of the sand filter.
3. The underdrain pipe must be sized and perforated as to ensure free draining of the sand filter bed. Round perforations must be at least 1/2-inch in diameter and the pipe must be laid with holes downward.
4. The maximum perpendicular distance between any two lateral collection pipes or from the edge of the filter and the collection pipes shall be 9 feet.



5. All pipes must be placed with a minimum slope of 0.5%.
6. The invert of the underdrain outlet must be above the seasonal high groundwater level.
7. At least 8 inches of gravel backfill must be maintained over all underdrain piping, and at least 6 inches must be maintained on both side and beneath the pipe to prevent damage by heavy equipment during maintenance. Either drain rock or gravel backfill may be used between pipes.
8. The bottom gravel layer shall have a diameter at least 2 times the size of the openings into the drainage system. The grains shall be hard, preferably rounded, with a specific gravity of at least 2.5, and free of clay, debris and organic impurities.
9. Either a geotextile fabric or a two-inch transition gradation layer (i.e., choking stone layer) must be placed between the sand layer and the drain rock or gravel backfill layer. If a geotextile is used, one inch of drain rock or gravel backfill shall be placed above the fabric. This allows for a transitional zone between sand and gravel and may reduce pooling of water at the liner interface. The geotextile must meet the following minimum materials requirements.

| Geotextile Property    | Value           | Test Method |
|------------------------|-----------------|-------------|
| Trapezoidal Tear (lbs) | 40 (min)        | ASTM D4533  |
| Permeability (cm/sec)  | 0.2 (min)       | ASTM D4491  |
| AOS (sieve size)       | #60 - #70 (min) | ASTM D4751  |
| Ultraviolet resistance | 70% or greater  | ASTM D4355  |

***Flow Spreading***

1. A flow spreader shall be installed at the inlet along one side of the filter to evenly distribute incoming runoff across the filter and to prevent erosion of the filter surface.
  - a. If the sand filter is curved or an irregular shape, a flow spreader shall be provided for a minimum of 20 percent of the filter perimeter.
  - b. If the length-to-width ratio of the filter is 2:1 or greater, a flow spreader must be located on the longer side and for a minimum length of 20 percent of the facility perimeter.
  - c. In other situations, use good engineering judgment in positioning the spreader.
2. Erosion protection shall be provided along the first foot of the sand bed adjacent to the flow spreader. Geotextile weighted with sand bags at 15-foot intervals may be used. Quarry spalls (small rock) may also be used.

***Vegetation***

1. The use of vegetation in sand filters is optional. However, no top soil shall be added to the sand filter bed because the fine-grained materials (silt and clay) reduce the hydraulic capacity of the filter.

2. Growing grass or other vegetation requires the selection of species that can tolerate the demanding environment of a sand filter bed. Plants not receiving sufficient dry weather flows must be able to withstand long periods of drought during summer periods, followed by periods of saturation during storm events. A landscape design professional shall be consulted for advice on species selection
3. A sod grown in sand may be used on the sand surface as long as there is no clay in the sand substrate and the particle size gradation of the substrate meets the sand filter specifications. No other sod shall be used due to the high clay content in most sod soils.
4. To prevent uses that could compact and damage the filter surface, permanent structures are not permitted on sand filters (e.g., playground equipment).
5. A sand filter can add aesthetics to a site and shall be incorporated into a project's landscape design. Interior side slopes may be stepped with flat areas to provide informal seating with a game or play area below. Perennial beds may be planted above the overflow water surface elevation. However, large shrubs and trees are not recommended as shading limits evaporation and falling leaves can clog the filter surface. If a sand filter area is intended for recreational uses, such as a volleyball area, the interior side slopes of the filter embankment shall be no steeper than 4:1 and may be stepped.
6. Landscaping outside of the facility must adhere to the following criteria so as not to hinder maintenance operations:
  - a. No trees or shrubs may be planted within 15 feet of inlet or outlet pipes or manmade drainage structures such as spillways, flow spreaders, or earthen embankments. Species with roots that seek water, such as willow or poplar, shall not be used within 50 feet of pipes or manmade structures. Weeping willow (*Salix babylonica*) shall not be planted in or near detention basins.
  - b. Prohibited non-native plant species will not be permitted. For more information on invasive weeds, including biology and control of listed weeds, look at the encycloweedia located at the California Department of Food and Agriculture website- [http://www.cdffa.ca.gov/phpps/ipc/encycloweedia/encycloweedia\\_hp.htm](http://www.cdffa.ca.gov/phpps/ipc/encycloweedia/encycloweedia_hp.htm) or the California Invasive Plant Council website at [www.cal-ipc.org](http://www.cal-ipc.org).
7. See Appendix G for a recommended native plant list for sand filters, a list of local nurseries where these plants can be purchased, and a list of local and regional on-line resources. The plant list shall be used as a guide only and shall not replace project-specific planting recommendations provided by a landscape professional including recommendations on appropriate plants, fertilizer, mulching applications, and irrigation requirements (if any) to ensure healthy vegetation growth. See Section 5.11 for more information on landscaping/planting recommendations and Section 5.10 for more information on soil amendment recommendations.

### ***Emergency Overflow Structure***

Sand filters shall be placed off-line, but an emergency overflow must still be provided in the event the filter becomes clogged. The overflow structure must be able to safely convey flows from the water quality design storm to the downstream storm water conveyance system or other acceptable discharge point (Figure 6-32).

### ***Side Slopes***

1. Interior side slopes above the water quality design depth and up to the emergency overflow water surface shall be no steeper than 4:1 (H:V), unless stabilization has been approved by a licensed civil engineer and the City.
2. Exterior side slopes shall be no steeper than 2:1 (H:V), unless stabilization has been approved by a licensed civil engineer and the City.
3. For any slope (interior or exterior) greater than 2:1 (H:V), a geotechnical investigation and report must be submitted and approved by the City.
4. Landscaped slopes must be no greater than 3:1 (H:V) to allow for maintenance.
5. Basin walls may be vertical retaining walls, provided: (a) they are constructed of reinforced concrete, (b) a fence is provided along the top of the wall (see fencing below) or further back, and (c) the design is stamped by a licensed civil engineer and approved by the City.

### ***Embankments***

Earthworks and berm embankments shall be performed in accordance with the latest edition of the "Greenbook Standard Specifications for Public Works Construction".

1. Embankments are earthen slopes or berms used for detaining or redirecting the flow of water.
2. Typically, the top width of berm embankments are at least 20 feet, but narrower embankments may be plausible if approved by the civil engineer and the City.
3. Top of berm shall be 2 feet minimum below the water quality design water surface and shall be keyed into embankment a minimum of 1 foot on both sides.
4. Basin berm embankments must be constructed on native consolidated soil (or adequately compacted and stable fill soils analyzed by a licensed civil engineer) free of loose surface soil materials, roots, and other organic debris.
5. The berm embankment shall be constructed of compacted soil (95% minimum dry density, modified proctor method per ASTM D1557), placed in 6-inch lifts.
6. Basin berm embankments greater than 4 feet in height must be constructed by excavating a key equal to 50% of the berm embankment cross-sectional height and width. This requirement may be waived if specifically recommended by a licensed civil engineer.

7. The berm embankment shall be constructed of compacted soil (95% minimum dry density, modified proctor method per ASTM D1557), placed in 6-inch lifts.
8. Low growing native or non-invasive perennial grasses shall be planted on downstream embankment slopes. See vegetation section below.

### ***Fencing***

Safety is provided either by fencing of the facility or by managing the contours of the basin to eliminate drop-offs and other hazards.

1. In accordance with the Santa Barbara Flood Control District *Standard Conditions of Project Plan Approval*, facilities to be dedicated to the City, perimeter fencing (minimum height of 42 inches) shall be required on all basins exceeding two feet in depth or where interior side slopes are steeper than 6:1 (H:V).
2. If fences are required, fences shall be designed and constructed in accordance with current policies of the Santa Barbara County Flood Control District and must be located at or above the overflow water surface elevation. Shrubs (approved, California-adapted species) can be used to hide the fencing. See vegetation section above.

### ***Right-of-Way***

1. Constructed treatment wetlands and associated access roads to be maintained by the City shall be dedicated in fee or in an easement to the City with appropriate access.

### ***Maintenance Access***

1. Ownership of the basin and maintenance thereof is the responsibility of the developer/applicant. A maintenance agreement with the City is required to ensure adequate performance and allow the City emergency access to the facilities.
2. Maintenance access road(s) shall be provided to the control structure and other drainage structures associated with the basin (e.g., inlet, emergency overflow or bypass structures). Manhole and catch basin lids must be in or at the edge of the access road.
3. A graded 16-foot wide access ramp into the basin shall be constructed near the basin outlet. An access ramp is required for removal of sediment with a backhoe or loader and truck. The ramp must extend to the basin bottom to avoid damage to vegetation planted on the basin slope. A 16-foot wide commercial driveway approach shall be provided where curb and gutter front the maintenance ramp.
4. All access ramps and roads shall be provided in accordance with the current policies of the Flood Control District.

#### **6.6.4.4 Construction Considerations**

The use of treated wood or galvanized metal anywhere inside the facility is prohibited.

Figure 6-10: Sand Filter Schematic

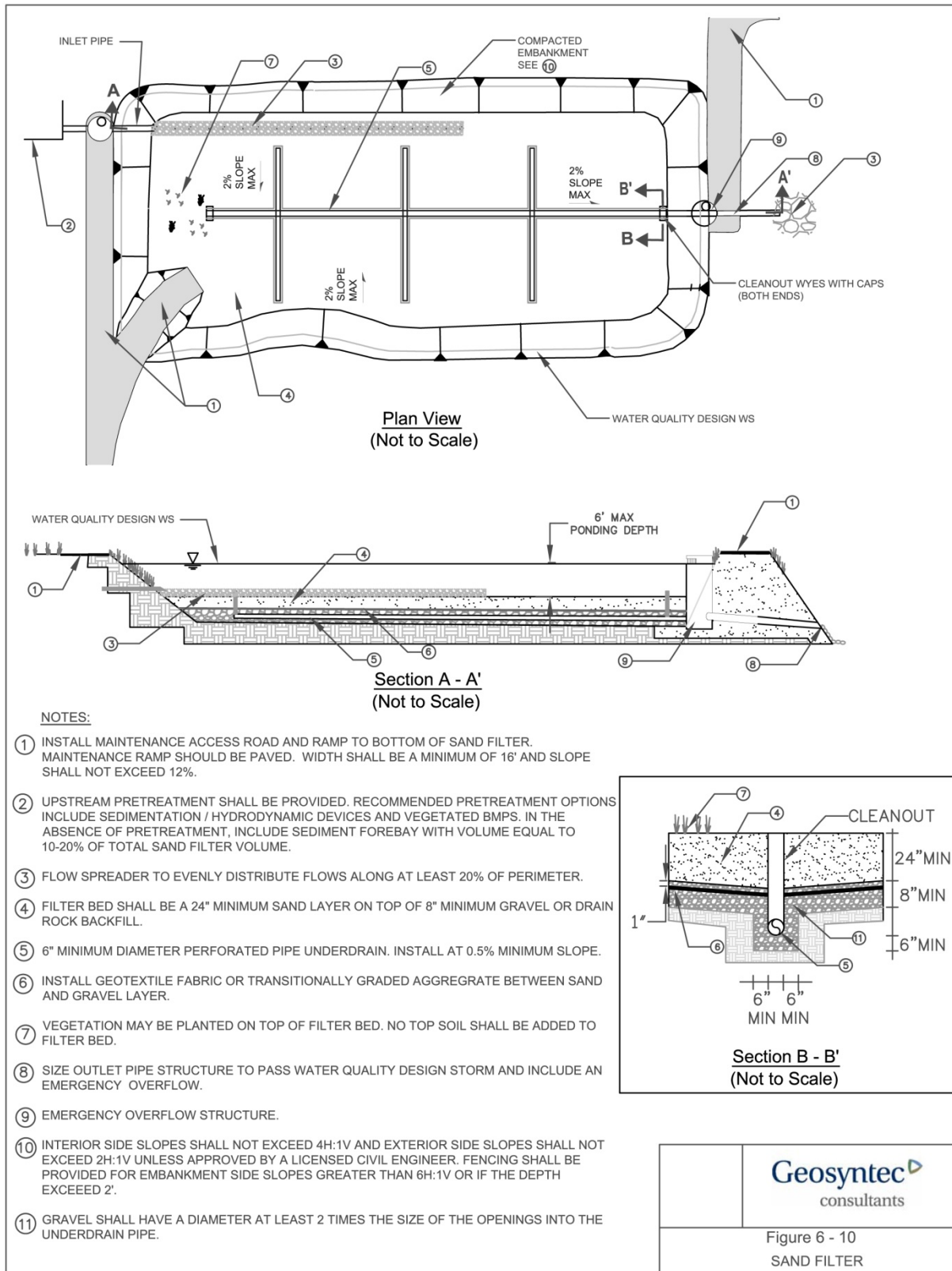

**6.6.4.5 Operations and Maintenance**

**General Requirements**

Sand filters are subject to clogging by fine sediment, oil and grease, and other debris (e.g., trash and organic matter such as leaves). Filters and pretreatment facilities shall be inspected every 6 months during the first year of operation (see Appendix H for a sand filter inspection and maintenance checklist). Inspections shall also occur immediately following a storm event to assess the filtration capacity of the filter. Once the filter is performing as designed, the frequency of inspection may be reduced to once per year.

Most of the maintenance shall be concentrated on the pretreatment practices, the filter strips and vegetated swales upstream of the sand filter to ensure that sediment does not reach the sand filter. Regular inspection shall determine if the sediment removal structures require routine maintenance.

**Maintenance Standards**

A summary of the routine and major maintenance activities recommended for sand filters is shown in Table 6-28. Detailed routine and major maintenance standards are listed in Table 6-29 and Table 6-30.

**Table 6-28: Sand Filter Maintenance Quick Guide**

| <b>Inspection and Maintenance Activities Summary</b> |   |
|--|---|
| <b>Routine Maintenance</b>                           | <ul style="list-style-type: none"> <li>• Remove trash and debris</li> <li>• Repair and re-seed erosion near inlet</li> <li>• Remove any evidence of visual contamination from floatables such as oil and grease</li> <li>• Clean under-drain and outlet piping to alleviate ponding and restore infiltrative capacity if needed</li> <li>• Clean and reset flow spreaders as needed to maintain even distribution of low flows</li> <li>• Remove minor sediment accumulation, debris, and obstructions near inlet and outlet structures as needed</li> <li>• Mow, weed, and trim routinely (where applicable) to maintain ideal grass height and to suppress weeds</li> </ul> |
| <b>Major Maintenance</b>                             | <ul style="list-style-type: none"> <li>• Clean out under-drains if present to alleviate ponding. Replace filter bed media if ponding or loss of infiltrative capacity persists and re-vegetate as needed</li> <li>• Reset settled piping, add fill material to maintain original pipe flow line elevations</li> <li>• Repair structural damage to flow control structures including inlet, outlet, and overflow structures</li> </ul>   |

**Table 6-29: Routine Maintenance – Sand Filters**

| Defect  | Conditions When Maintenance Is Needed   | Results Expected When Maintenance Is Performed   | Frequency  |
|---|---|--|--|
| Trash & Debris  | Any trash and debris which exceed 5 cubic feet per 1,000 square feet of filter bed area (one standard garbage can). In general, there shall be no visual evidence of dumping.<br>If less than threshold all trash and debris will be removed as part of next scheduled maintenance. | Trash and debris cleared from site.  | Annually prior to wet season<br><br>After major storm events (>0.75 inches/24 hrs) if spot checks indicate widespread damage/maintenance needs |
| Inlet erosion   | Visible evident of erosion occurring near flow spreader outlets.  | Eroded areas repaired/reseeded.  |  |
| Slow drain time   | Standing water long after storm has passed (after 24 to 48 hours) and/or flow through the overflow pipes occurs frequently.   | Water drains within 48 hours. This is achieved through cleaning or backflushing the drainage pipe, removing accumulated litter on surface or removing and renewing top 1-2" of filter media. If this does not cure problem then see major maintenance. | Litter removal is dependent on site conditions and desired aesthetics and shall be done at a frequency to meet those objectives                |
| Concentrated Flow                                       | Flow spreader uneven or clogged so that flows are not uniformly distributed across the sand filter.   | Level the spreader and clean so that flows are spread evenly over the sand filter bed.   |  |
| Appearance of poisonous, noxious or nuisance vegetation | Excessive grass and weed growth. Noxious weeds, woody vegetation establishing, Turf growing over rock filter  | Mowing, weeding and trimming to restore function and prevent noxious and nuisance plants from establishing   | Monthly (or as dictated by agreement between County and landscape contractor)  |

**Table 6-30: Major Maintenance – Sand Filters**

| Defect                | Conditions When Maintenance Is Needed  | Results Expected When Maintenance Is Performed   | Frequency |
|-----------------------|--|--|-----------|
| Standing Water        | Standing water long after storm has passed (after 24 to 48 hours), and/or flow through the overflow pipes occurs frequently. | Design infiltration rate achieved, either through excavation and filter media replacement or sediment removal from existing media. If the underdrain is clogged, filter fabric must be removed and the pipe cleaned. | As needed |
| Tear in Filter Fabric | When there is a visible tear or rip in the filter fabric allowing water to bypass the fabric.                                | Filter fabric repaired and/or replaced.  |           |
| Pipe Settlement       | If piping has visibly settled more than 1 inch.  | Pipe is returned to original height. Add fill material to bring pipe back to grade. If erosion is evident around pipe, inspect for cracks or leaks.  |           |



## 6.7 Infiltration BMPs



**Figure 6-11: Infiltration Basin**

*Photo Credit: Pennsylvania Stormwater BMP Manual*

### 6.7.1 Description

Infiltration BMPs included in this manual include infiltration basins, infiltration trenches, and drywells. In general, infiltration BMPs are similar to storm water detention systems but are constructed with a highly permeable base that is specifically designed to infiltrate runoff. It is usually not practical to infiltrate runoff at the same rate that it is generated; therefore, these facilities generally include both a storage component and a drainage component.

**Infiltration basins** are usually shallow with flat, vegetated bottoms and side slopes and can be incised by excavating a depression below the existing grade or constructed above grade by constructing a perimeter berm.

**Infiltration trenches** are long, narrow, rock-filled trenches that receive storm water runoff from small drainage areas. These facilities may include a shallow depression at the surface, but the majority of runoff is stored in the void space between the stones and infiltrates through the sides and bottom of the trench.

**Drywells** are similar to infiltration trenches in their design and function. A dry well is a subsurface storage facility designed to temporarily store and infiltrate runoff, primarily from rooftops or other impervious areas with low sediment loading. A dry well may be either a small excavated pit filled with aggregate or a prefabricated storage chamber or pipe segment.

Pretreatment BMPs such as vegetated swale filters, Vegetated filter strips, and sediment forebays, basins, and manholes minimize sediment loads to infiltration facilities are recommended to increase longevity and reduce the maintenance burden of infiltration facilities.

### Applications

- Mixed-use and commercial
- Roads and parking lots
- Parks and open spaces
- Single and multi-family residential

### Performance

- Efficient removal of trash and sediment
- High volume reduction
- Simple; low cost
- Can integrate with parks

### Limitations

- Requires large pervious area
- High maintenance requirement; clogging potential is high
- Potential groundwater contamination

**6.7.2 Performance, Applicability, and Limitations**

Table 6-17 provide a summary of BMP performance, applicability, and limitations for infiltration BMPs. *It is important to note that information in these tables shall be used to provide general guidance for infiltration BMPs and shall not replace the evaluation performed by a water quality professional.*

**Performance**

Table 6-31 and associated guidance provide general volume reduction capabilities and treatment effectiveness for infiltration BMPs. Refer to Section 6.4 for the process that shall be used for selecting BMPs based on pollutants of concern. Refer to Table 6-1 to determine the ranking of infiltration BMPs for removal of pollutants of concern as compared with other storm water runoff BMPs provided in Chapter 6. Refer to Table 6-2 to assess the applicability of infiltration BMPs for your site based on site suitability considerations as compared with other storm water runoff BMPs provided in Chapter 6. Infiltration BMPs are volume-based BMPs that, depending on site conditions, can be designed to meet all or part of the water quality treatment and volume reduction requirements (see Table 6-31). Infiltration BMPs also assist in meeting the peak runoff discharge rate requirements (see “Additional Control Functions” section below). See Section 6.2 for specific storm water runoff requirements for Tier 3 projects.

**Table 6-31: Volume Reduction & Treatment Effectiveness for Infiltration BMPs**

| Storm Water Runoff BMP   | Volume Mitigation (% of inflow) | Treatment Effectiveness for Pollutants of Concern <sup>1</sup> |           |          |  |          |  |
|--|---------------------------------|--|-----------|----------|--|----------|--|
|  |                                 | Trash  | Nutrients | Bacteria | Metals (particulate and dissolved fractions) | Sediment | Organics (hydrocarbons, oil, and grease) |
| Infiltration Facilities  | ●                               | ●  | ●         | ●        | ●  | ●        | ●  |
| Volume/Treatment Effectiveness: ● = Very High, ◐ = High, ◑ = Moderate, ◒ = Low, ○ = Very Low |                                 |  |           |          |  |          |  |

<sup>1</sup> Effectiveness may change based on design variations; standard BMP designs have been assumed.

Infiltration BMPs are good candidates for the removal of sediment, particulate bound pollutants, and bacteria. Sedimentation of coarse particles shall however, be minimized through the use of appropriate pretreatment devices to prevent clogging. In general, it is assumed that infiltration BMPs located in areas with acceptable infiltration rates and the required minimum depth to groundwater, provide for complete reduction of pollutants before the infiltrated runoff reaches groundwater through sedimentation, filtration, adsorption, and biodegradation which occur as runoff infiltrates through the BMP and then through the subsoil.

**Site Suitability Recommendations and Limitations**

Table 6-32 and associated guidance provide general considerations for assessing a site's suitability for infiltration BMPs.

**Table 6-32: Site Suitability Considerations for Infiltration BMPs**

| BMP                     | Tributary Area (Acres) <sup>1</sup> | Site Slope (%)   | Depth to Seasonally High Groundwater Table (ft) | Hydrologic Soil Group  | Horizontal Setback from Drinking Water Wells (ft) |
|-------------------------|-------------------------------------|------------------|---|--|---|
| Infiltration Facilities | < 5 Acres;<br>217,800 Sq. Ft.       | < 7 <sup>2</sup> | > 5   | May not be feasible in "C" soils. Not suitable in "D" soils. | 100   |

<sup>1</sup> Tributary area is the area of the site draining to the BMP. Tributary areas provided here shall be used as a general guideline only. Tributary areas can be larger or smaller in some instances.

<sup>2</sup> If site slope exceeds that specified or if the system is within 200 ft from the top of a hazardous slope or landslide area (on the uphill side), a geotechnical investigation and report addressing slope stability shall be prepared by a licensed civil engineer.

Table 6-33 provides additional site applicability considerations for special design districts within the City, including coastal bluff areas and hillside design districts.

**Table 6-33: Applicability of Infiltration BMPs for Special Design Districts**

| Coastal Bluff Area   | Hillside Design District   |
|--|--|
| Infiltration BMPs are <u>not</u> permissible in Coastal Bluff Areas. | Acceptable if a geotechnical investigation proves that the facility does not compromise the stability of the site slope or surrounding slopes. |

Due to the potential to cause slope instability, impact surrounding engineering structures, and contaminate groundwater, an extensive soil assessment and potential geotechnical investigation for slope stability must be undertaken early in the site planning process to verify site suitability for the installation of infiltration BMPs. Soil infiltration rates and the seasonally high groundwater table depth shall be evaluated to ensure that conditions are satisfactory for proper operation of an infiltration BMP (see Chapter 3).

The applicant must demonstrate through infiltration testing, soil logs, and the written opinion of a licensed civil engineer that sufficiently permeable soils exist on-site to allow the construction of a properly functioning infiltration BMP. An additional geotechnical investigation may be required if the facility is placed in an area that could potential cause slope instability.

The following site suitability and geotechnical recommendations and limitations shall be considered before choosing to use infiltration BMPs.

- In general, tributary area shall be limited to less than 5 acres to limit the size of the infiltration BMP and limit loading rates of sediment which can cause premature clogging. If tributary areas are greater than 5 acres, significant pretreatment shall be provided.
- The upstream tributary area shall be stabilized to minimize sediment delivery to the infiltration BMP.
- Pretreatment for coarse sediment removal is required in all instances. High loading rates may clog quickly if flows are not adequately pretreated.
- Infiltration BMPs require a minimum soil infiltration rate of 0.05 inches/hour. If infiltration rates exceed 2.4 inches/hour, then the runoff shall be fully treated in an upstream BMP prior to infiltration to protect groundwater quality. In addition, shallow confining layers or bedrock may inhibit infiltration. The design infiltration rate shall account for clogging and compaction over time by multiplying the field measured infiltration rate by an appropriate correction factor as described in the design criteria and procedure section below. Preferably, measurements of groundwater levels shall be made during the time when water level is expected to be at a maximum (i.e., toward the end of the wet season). If this is not feasible, indications of the seasonally high groundwater table shall be identified during soil testing (see Chapter 3).
- Groundwater separation must be at least 5 feet between bottom of the basin, trench, or dry well and the measured seasonally high groundwater surface elevation. The separation between the bottom of the facility and bedrock shall be at least 3 feet.
- If the site slope exceeds 7%, a geotechnical investigation and report addressing slope stability is required.
- An infiltration facility must not be located within 50 feet of a 2:1 (H:V) or greater slope. If the infiltration facility is within 200 feet of a hazardous steep slope or mapped landslide area, a geotechnical investigation and report is required.
- Infiltration BMPs shall be located at least 100 feet away from drinking water wells, waterbodies, and septic system leach fields.
- Infiltration BMPs shall be located at least 20 feet from any structural foundation. The 20 foot setback may be reduced to a minimum of 5 feet if geotechnical investigations address the potential impacts of the facility on adjacent structural foundations.
- Infiltration BMPs are not suitable to collect runoff from hotspot sites that use or store chemicals or hazardous materials unless hazardous and toxic materials are prevented from contaminating the runoff. [*Note: Infiltration BMPs are not suitable for industrial sites or locations where spills can occur. In these areas, other BMPs that do not allow for interaction with the groundwater table shall be used*].
- Infiltration BMPs are not suitable for un-remediated "brownfield sites" where there is known groundwater or soil contamination.

**Additional Control Functions**

Infiltration basins can be designed to provide flow control by providing storage capacity in excess of that provided by infiltration and incorporating outlet controls. The additional storage and outlet structure shall be provided per the requirements outlined in the Dry Extended Detention Basins section of this document (see Section 6.10.3). Note that the selected outlet structure shall not be designed to drain the design volume intended for infiltration and shall be similar to outlet structures that maintain a permanent pool (see Section 6.10.2 – Wet Retention Basins).

**Multi-Use Opportunities**

Infiltration basins may be integrated into the design of a park or playfield. Recreational multi-use facilities must be inspected after every storm and may require a greater maintenance frequency than dedicated infiltration basins as to ensure aesthetics and public safety are not compromised. Any planned multi-use facility must obtain approval by the affected City and County department(s).

**6.7.3 Design Criteria and Procedure**

The main challenge associated with infiltration BMPs is preventing system clogging and subsequent infiltration inhibition. Principal design criteria for infiltration BMPs are listed in Table 6-34. Schematics of infiltration BMPs are illustrated in Figure 6-12 (infiltration basins), Figure 6-13, (infiltration trench), and Figure 6-14 (dry well).

**Table 6-34: Infiltration BMP Design Criteria**

| Design Parameter                              | Unit            | Design Criteria   |   |
|---|-----------------|---|---|
| Water quality design volume, $V_{wq}$         | ft <sup>3</sup> | See Section 6.2 and Appendix C for calculating $V_{wq}$ .   |   |
| Volume reduction requirement, $V_{reduction}$ | ft <sup>3</sup> | See Section 6.2 and Appendix C for calculating $V_{reduction}$ .  |   |
| Design drawdown time                          | hr              | 72  |   |
| Pretreatment                                  | -               | Filter strip, vegetated swale, proprietary device, or sedimentation forebay for all surfaces other than roofs; if sheet flow, max velocity = 1 ft/sec |   |
| Design infiltration rate, $k_{design}$        | in/hr           | Shall be corrected for testing method, potential for clogging and compaction over time, and facility geometry   |   |
| Maximum depth of facility, $d_{max}$          | ft              | Defined by the design infiltration rate and the design drawdown time (includes ponding depth and depth of media)                                      |   |
| Surface area of facility, A                   | ft <sup>2</sup> | Infiltration Basin  | Based on depth of ponding   |
|   |                 | Infiltration Trench   | Based on depth of ponding (if applicable) and depth of trench media |
|   |                 | Dry Well  | Based on depth of dry well media                                    |
| Facility geometry                             | -               | Infiltration Basin  | Forebay (if applicable), 25% of facility volume; flat bottom slope  |

| Design Parameter                               | Unit   | Design Criteria  |   |
|--|--------|--|---|
|  |        | Infiltration Trench                                    | Max 24 inches wide and max 5 feet deep; max 3% bottom slope |
|  |        | Dry Well   | Geometry varies; max 10 feet deep; flat bottom slope        |
| Filter media diameter (trenches and dry wells) | inches | 1.5 – 3 (gravel); prefabricated media may also be used |   |
| Vegetation                                     | -      | Required for infiltration basins                       |   |
| Underdrain                                     | -      | 6 inch. minimum diameter; 0.5% minimum slope           |   |
| Overflow device                                | -      | Required if system is on-line                          |   |

***Soil Assessment and Site Geotechnical Investigation Reports***

The soil assessment report shall:

- State whether the site is suitable for the proposed infiltration BMP
- Recommend a design infiltration rate (see the “Design Infiltration Rate” section below).
- Identify the seasonally high depth to groundwater table surface elevation
- Provide a good understanding of how the storm water runoff will move in the soil (horizontally or vertically) and if there are any geological conditions that could inhibit the movement of water.

If a geotechnical investigation and report are required, the report shall:

- Provide a written opinion by a professional civil engineer describing whether the infiltration BMP will compromise slope stability.
- Identify potential impacts to nearby structural foundations.

***Pretreatment***

Pretreatment is required for infiltration BMPs in order to reduce the sediment load entering the facility and maintain the infiltration rate of the facility. Pretreatment refers to design features that provide settling of large particles before runoff reaches a management practice; easing the long-term maintenance burden. Pretreatment is important for most all structural storm water BMPs, but it is particularly important for infiltration BMPs. To ensure that pretreatment mechanisms are effective, designers shall incorporate sediment reduction practices. Sediment reductions BMPs may include vegetated swales, vegetated filter strips, sedimentation basins or forebays, sedimentation manholes and hydrodynamic separation devices. The use of at least two pretreatment devices is highly recommended for infiltration facilities.

For design specification of selected pre-treatment devices, refer to:

- Vegetated filter strip (Section 6.6.2)
- Vegetated swale filter (Section 6.2.2)
- Proprietary devices (Section 6.11)

## *Geometry and Sizing*

### Infiltration Basins

1. Infiltration basins shall be designed and constructed with the flattest bottom slope possible to promote uniform ponding and infiltration across the facility.
2. A sediment forebay is required unless adequate pretreatment is provided in a separate pretreatment unit (e.g., vegetated swale, filter strip, hydrodynamic device) to reduce sediment loads entering the infiltration basin. The sediment forebay, if present, shall have a volume equal to 25% of the total infiltration basin volume.
3. The forebay shall be designed with a minimum length to width ratio of 2:1 and must completely drain to the main basin through an 8-inch minimum low-flow outlet within 10 minutes.
4. All inlets shall enter the sediment forebay. If there are multiple inlets, the length-to-width ratio shall be based on the average flowpath length for all inlets.
5. Side-slopes shall be no steeper than 3H:1V.

### Infiltration Trenches

1. Infiltration trenches shall be at least 24 inches wide and 3 to 5 feet deep.
2. The longitudinal slope of the trench shall not exceed 3%.
3. The filter bed media layers shall have the following composition and thickness:
  - a. Top layer – If storm water runoff enters the top of the trench via sheet flow at the ground surface then the top 2 inches shall be pea gravel with a thin 2- to 4-inch layer of pure sand and 2-inch layer of chocking stone (e.g., #8) or equivalent geotextile fabric layer placed between the top layer and the middle layer to capture sediment before entering the trench. If storm water runoff enters the trench from an underground pipe, pretreatment prior to entry into the trench is required. The top layer over the trench shall be 12 inches of surface soil (i.e., overburden)
  - b. Middle layer (3-5 feet of washed 1.5 to 3-inch gravel). Void space shall be in the range of 30 percent to 40 percent.
  - c. Bottom layer (6" of clean, washed sand to encourage drainage and prevent compaction of the native soil while the stone aggregate is added).
4. One or more observation wells shall be installed, depending on trench length, to check for water levels, drawdown time, and evidence of clogging. A typical observation well consists of a slotted PVC well screen, 4 to 6 inches in diameter, capped with a lockable, above-ground lid.

### Dry Wells

1. Dry well configurations vary but generally they have length and width dimensions closer to square than infiltration trenches. Pre-fabricated dry-wells are often circular. The surface area of the dry well must be large enough to infiltrate the storage volume in 72 hours based on the maximum depth allowable,  $d_{\max}$ .
2. The bottom slope shall be level.
3. Maximum 10 feet deep.
4. The filter bed media layers are the same as for infiltration trenches unless prefabricated dry wells and/or media are used. The porosity of gravel media systems is generally 30-40% and is 80-95% for prefabricated media systems.
5. If dry well receives runoff from an underground pipe (i.e., runoff does not enter the top of the dry well from the ground surface), a fine mesh screen shall be installed at the inlet. The inlet elevation shall be 18 inches below the ground surface (i.e., below 12 inches of surface soil and 6 inches of dry well media).
6. An observation wells shall be installed to check for water levels, drawdown time, and evidence of clogging. A typical observation well consists of a slotted PVC well screen, 4 to 6 inches in diameter, capped with a lockable, above-ground lid.

### ***Sizing Methodology***

Infiltration facilities shall be sized to capture and infiltrate all or part of the volume reduction requirement,  $V_{\text{reduction}}$  or the water quality design volume,  $V_{\text{wq}}$ , whichever is larger (see Section 6.2 and Appendix C for further detail). Procedures for sizing infiltration BMPs are summarized below. An infiltration BMP sizing example is provided in Appendix D.

#### *Step 1: Determine the design infiltration rate of the native subsoil*

See the Bioretention Area Section 6.6.1 for the method used to determine the design infiltration rate of the native subsoil.

#### *Step 2: Size the infiltration BMP*

As with sand filters, infiltration BMPs can be sized using one of two methods: a simple sizing method or a routing modeling method. With either method, the runoff entering the facility must be completely infiltrated within 72 hours. Infiltration basins provide the majority of storage above ground while infiltration trenches and dry wells provide the majority of storage in the voids of the rock fill. The simple sizing procedures provided below can be used for infiltration basins, infiltration trenches, or dry wells. For the routing modeling method, refer to the Bioretention Area Section 6.6.1.

Determine the size of the required infiltrating surface by assuming the design runoff volume (i.e., all or part of the water quality design volume,  $V_{\text{wq}}$ , or the volume reduction requirement,  $V_{\text{reduction}}$ , whichever is larger) will fill the available ponding depth plus the void spaces based on the computed porosity of the filter media (normally about 32% for gravel). Note, dry wells



generally do not have a ponding depth; therefore, the design runoff volume shall fill the available void spaces based only on the porosity of the filter media.

Determine the maximum depth of runoff that can be infiltrated within the required drain time (72 hr) as follows:

$$d_{max} = \frac{k_{design}}{12} \times t \quad \text{(Equation 6-21)}$$

Where:

- $t$  = required drain time (hrs) [Use 72 hours]
- $k_{design}$  = infiltration rate of underlying soils (in/hr)
- $d_{max}$  = the maximum depth of water that can be infiltrated within the required drain time (ft)

Choose the ponding depth ( $d_p$ ) and/or trench depth ( $d_t$ ) such that:

$$d_{max} \geq d_p \quad \text{For Infiltration Basins} \quad \text{(Equation 6-22)}$$

$$d_{max} \geq n_t d_t + d_p \quad \text{For Infiltration Trenches} \quad \text{(Equation 6-23)}$$

$$d_{max} \geq n_t d_t \quad \text{For Dry Wells} \quad \text{(Equation 6-24)}$$

Where:

- $d_p$  = ponding depth (ft)
- $n_t$  = trench fill aggregate porosity (unitless)
- $d_t$  = depth of trench fill (ft)
- $d_{max}$  = the maximum depth of water that can be infiltrated within the required drain time (ft)

Calculate infiltrating surface area (filter bottom area) required:

$$A = \frac{V_{design}}{\left(\frac{Tk_{design}}{12} + d_p\right)} \quad \text{For Infiltration Basins} \quad \text{(Equation 6-25)}$$

$$A = \frac{V_{design}}{\left(\frac{Tk_{design}}{12} + n_t d_t + d_p\right)} \quad \text{For Infiltration Trenches} \quad \text{(Equation 6-26)}$$

$$A = \frac{V_{design}}{\left(\frac{Tk_{design}}{12} + n_t d_t\right)} \quad \text{For Dry Wells} \quad \text{(Equation 6-27)}$$

(Adapted from Georgia Stormwater Manual: <http://www.atlantaregional.com/environment/georgia-stormwater-manual>)

Where:

|              |   |   |
|--------------|---|---|
| $V_{design}$ | = | design volume of runoff to be infiltrated (ft <sup>3</sup> )                              |
| $n_t$        | = | trench or dry well media porosity (unitless); [commonly, $n_t = 0.32$ for gravel]         |
| $k_{design}$ | = | design infiltration rate (in/hr)  |
| $d_p$        | = | ponding depth (ft)  |
| $d_t$        | = | depth of trench fill (ft)   |
| $T$          | = | fill time (time to fill infiltration BMP with water) (hrs) [use 2 hours for most designs] |
| $A$          | = | surface area of infiltration BMP (ft <sup>2</sup> )                                       |

### ***Embankments***

1. Embankments are earthen slopes or berms used for detaining or redirecting the flow of water.
2. Top of berm shall be 2 feet minimum below the water quality design water surface and shall be keyed into embankment a minimum of 1 foot on both sides.
3. Typically, the top width of berm embankments is at least 20 feet, but narrower embankments may be plausible if approved by a licensed civil engineer and the Santa Barbara County Flood Control District.
4. Basin berm embankments must be constructed on native consolidated soil (or adequately compacted and stable fill soils analyzed by a licensed civil engineer) free of loose surface soil materials, roots, and other organic debris.
5. Basin berm embankments greater than 4 feet in height must be constructed by excavating a key equal to 50% of the berm embankment cross-sectional height and width. This requirement may be waived if specifically recommended by a licensed civil engineer.
6. The berm embankment shall be constructed of compacted soil (95% minimum dry density, modified proctor method per ASTM D1557), placed in 6-inch lifts.
7. Low growing native or non-invasive perennial grasses shall be planted on downstream embankment slopes. See vegetation specifications below and Appendix G Plant List.

### ***Drainage***

1. The bottom of infiltration bed must be native soil, over-excavated to at least one foot in depth and replaced uniformly without compaction. Amending the excavated soil with 2-4 inches (~15-30%) of coarse sand is recommended.
2. The use of vertical piping, either for distribution or infiltration enhancement shall not be allowed to avoid device classification as a Class V injection well per 40 CFR146.5(e)(4).
3. The hydraulic conductivity of the subsurface layers shall be sufficient to ensure a maximum 72-hr drawdown time. An observation well shall be incorporated to allow observation of drain time.

4. For infiltration basins, an underdrain shall be installed within the bottom layer to provide drainage in case of standing water. The underdrain shall be operated by opening a valve, which shall be closed during normal operation. Cleanouts shall be provided for the underdrain. See Sand Filter Section 6.6.4 for specifications for underdrains.

### ***Emergency Overflow***

1. There must be an overflow route for storm water flows that overtop the facility or in case the infiltration facility becomes clogged.
2. The overflow channel must be able to safely convey flows from the peak design storm to the downstream storm water conveyance system or other acceptable discharge point.

### ***Vegetation***

#### **Infiltration Basin**

1. A thick mat of drought tolerant grass shall be established on the basin floor and side-slopes following construction. Grasses can help prevent erosion and increase evapotranspiration and their roots discourage compaction helping to maintain the surface infiltration rates. Additionally, the active growing vegetation can help break up surface crusts that accumulate from sedimentation of fine particulates.
2. Grass may need to be irrigated during establishment.
3. For infiltration basins, landscaping is required outside of the basin and must adhere to the following criteria so as not to hinder maintenance operations:
  - a. No trees or shrubs may be planted within 10 feet of inlet or outlet pipes or manmade drainage structures such as spillways, flow spreaders, or earthen embankments. Species with roots that seek water, such as willow or poplar, shall not be used within 50 feet of pipes or manmade structures. Weeping willow (*Salix babylonica*) shall not be planted in or near detention basins.
  - b. Prohibited non-native plant species will not be permitted. For more information on invasive weeds, including biology and control of listed weeds, look at the encycloweedia located at the California Department of Food and Agriculture website- [http://www.cdfa.ca.gov/phpps/ipc/encycloweedia/encycloweedia\\_hp.htm](http://www.cdfa.ca.gov/phpps/ipc/encycloweedia/encycloweedia_hp.htm) or the California Invasive Plant Council website at [www.cal-ipc.org](http://www.cal-ipc.org).
4. See Appendix G for a recommended native plant list for infiltration BMPs, a list of local nurseries where these plants can be purchased, and a list of local and regional on-line resources. The plant list shall be used as a guide only and shall not replace project-specific planting recommendations provided by a landscape professional including recommendations on appropriate plants, fertilizer, mulching applications, and irrigation requirements (if any) to ensure healthy vegetation growth. See Section 5.11 for more information on landscaping/planting recommendations and Section 5.10 for more information on soil amendment recommendations.

#### **Infiltration Trench and Dry Well**

1. Infiltration trenches shall be kept free of vegetation.

2. Trees and other large vegetation shall be planted away from trenches and dry wells such that drip lines do not overhang infiltration beds.

### ***Maintenance Access***

#### Infiltration Basin

1. Infiltration basins require maintenance access provisions similar to dry extended detention basins (see Section 6.10.3).
2. A maintenance access road(s) shall be provided to the drainage structures associated with the basin (e.g., inlet, emergency overflow, or bypass structures). Manhole and catch basin lids must be in or at the edge of the access road.
3. An access ramp to the basin bottom is required to facilitate the entry of sediment removal and vegetation maintenance equipment without compaction of the basin bottom and side slopes.
4. Access roads shall meet the following design criteria:
5. A graded 16-foot wide maintenance ramp shall be provided that extends to the bottom of the sand filter near the outlet.
6. A 16-foot wide commercial driveway approach shall be provided where curb and gutter front the maintenance ramp.

#### Infiltration Trench and Dry Well

1. The facility and outlet structures must all be safely accessible during wet and dry weather conditions.
2. An access road along the length of the trench or dry well is required unless the trench is located along an existing road or parking lot that can be safely used for maintenance access.
3. If the infiltration facility becomes plugged and fails, then access is needed to excavate the facility to remove and replace the top layer or the filter bed media, as well as to increase all dimensions of the facility by 2 inches to provide a fresh surface for infiltration. To prevent damage and compaction, access must be able to accommodate a backhoe working at "arms length".

### ***6.7.4 Construction Considerations***

The use of treated wood or galvanized metal anywhere inside the facility is prohibited. The use of galvanized fencing is permitted if in accordance with the Fencing requirement above.

To preserve and avoid the loss of infiltration capacity, the following construction guidelines must be specified:

1. The entire area draining to the facility must be stabilized before construction begins. If this is impossible, a diversion berm must be placed around the perimeter of the infiltration site to prevent sediment entrance during construction.
2. Infiltration BMPs shall not be hydraulically connected to the storm water conveyance system until all contributing tributary areas are stabilized as shown on the Contract Plans and to the satisfaction of the Engineer. Infiltration BMPs shall not be used as sediment control facilities.
3. Compaction of the subgrade with heavy equipment shall be minimized to the maximum extent possible. If the use of heavy equipment on the base of the facility cannot be avoided, the infiltrative capacity shall be restored by tilling or aerating prior to placing the infiltrative bed.
4. The exposed soils must be inspected by a civil engineer after excavation to confirm that soil conditions are suitable.

**Figure 6-12: Infiltration Basin Schematic**

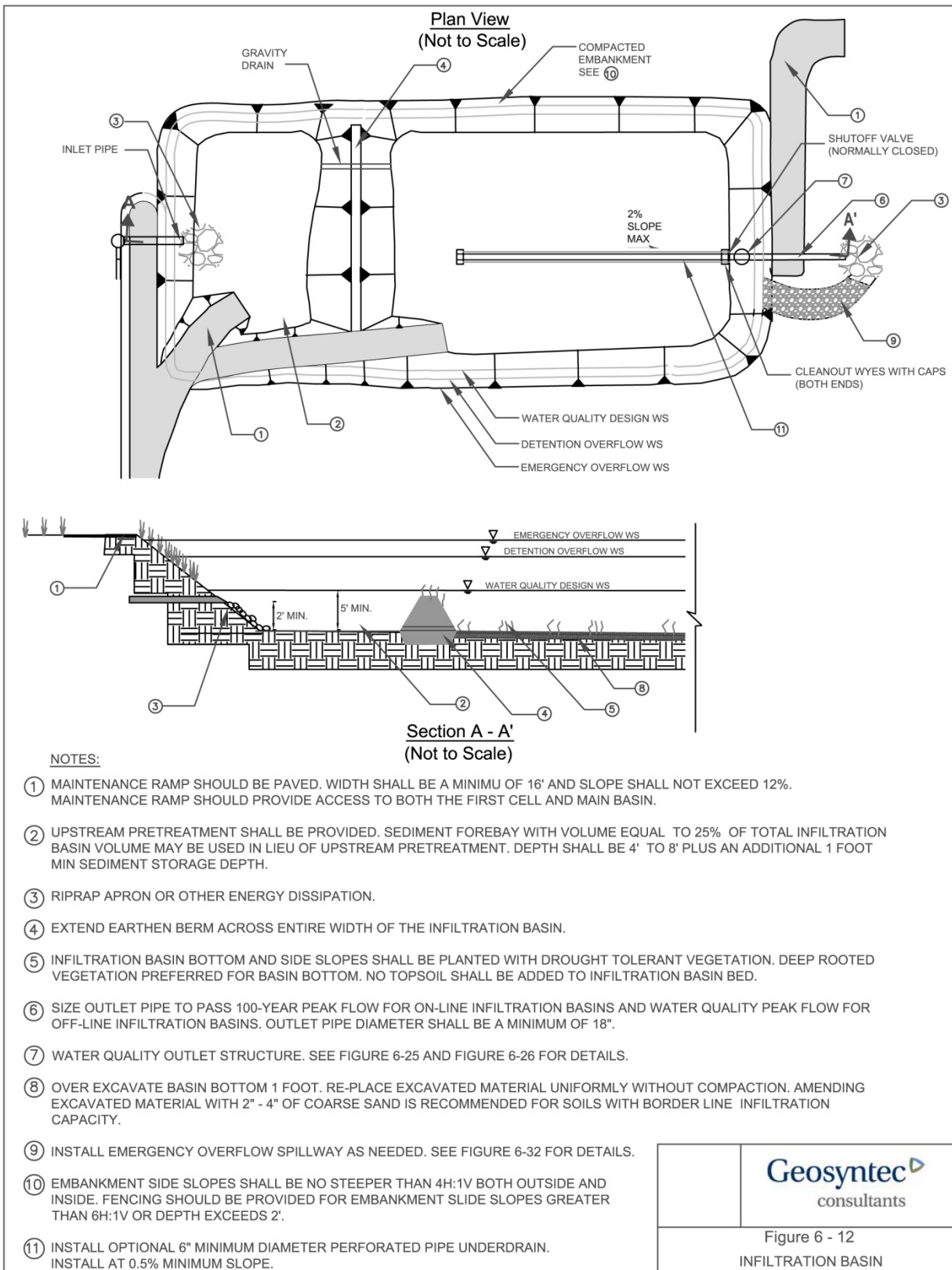

**Figure 6-13: Infiltration Trench Schematic**

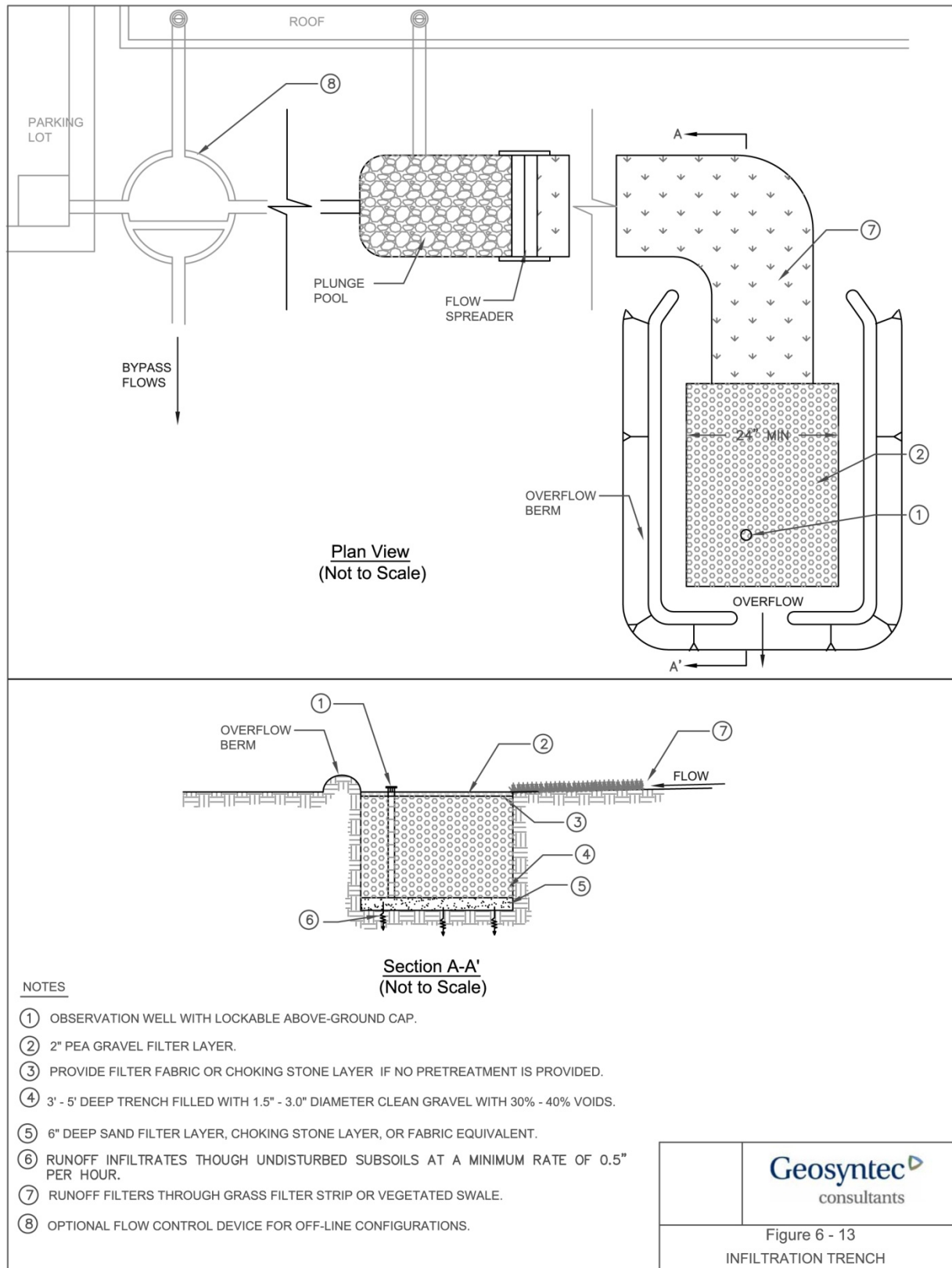
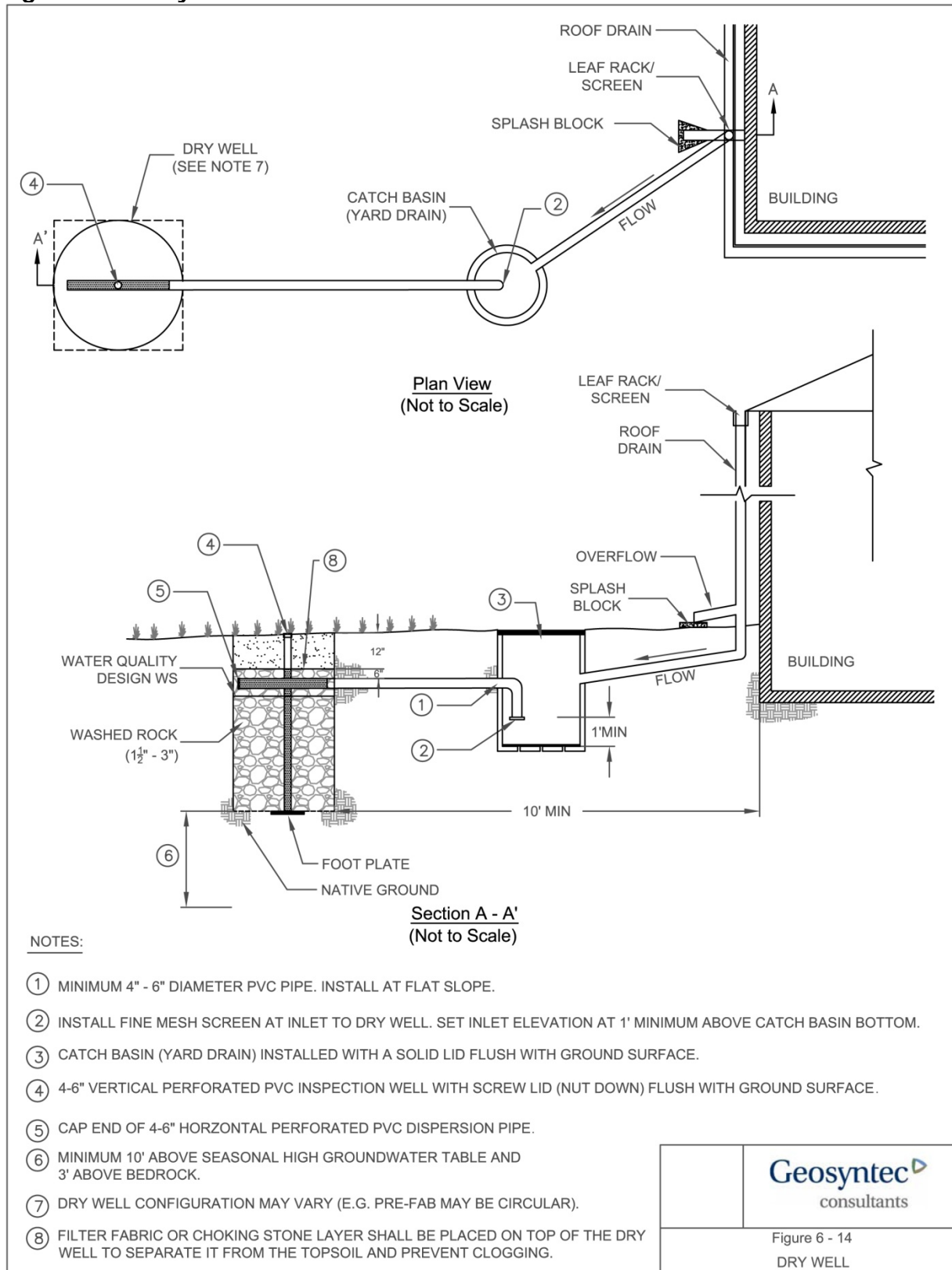

Figure 6-14: Dry Well Schematic





### ***6.7.5 Operations and Maintenance***

#### ***General Requirements***

Infiltration facility maintenance shall include frequent inspections to ensure that water infiltrates into the subsurface completely within the recommended infiltration time of 72 hours or less after a storm (see Appendix H for an infiltration BMP inspection and maintenance checklist).

Maintenance and regular inspections are of primary importance if infiltration BMPs are to continue to function as originally designed. A specific maintenance plan shall be formulated specifically for each facility outlining the schedule and scope of maintenance operations, as well as the data handling and reporting requirements. The following are general maintenance requirements:

1. Regular inspection shall determine if the pretreatment sediment removal BMPs require routine maintenance.
2. If water is noticed in the basin more than 72 hours after a major storm or in the observation well of the infiltration trench or dry well more than 48 hours after a major storm, the infiltration facility may be clogged. Maintenance activities triggered by a potentially clogged facility include:
3. Check for debris/sediment accumulation, rake surface and remove sediment (if any) and evaluate potential sources of sediment and debris (e.g., embankment erosion, channel scour, overhanging trees, etc). If suspected upland sources are outside of the City's jurisdiction, additional pretreatment operations (e.g., trash racks, vegetated swales, etc.) may be necessary.
4. For basins, removal of the top layer of native soil may be required to restore infiltrative capacity.
5. For trenches and drywells, assess the condition of the top aggregate layer for sediment buildup and crusting. Remove top layer of pea gravel and sediment capture layer (i.e., sand and choking stone layer or geotextile fabric) and replace. If slow draining conditions persist, entire trench or dry well may need to be excavated and replaced.
6. For trenches and drywells, if there is a tear in the filter fabric (if applicable), repair or replace.
7. Any debris or algae growth located on top of the infiltration facility shall be removed and disposed of properly.
8. Facilities shall be inspected annually. Trash and debris shall be removed as needed, but at least annually prior to the beginning of the wet season.
9. Site vegetation shall be maintained as frequently as necessary to maintain the aesthetic appearance of the site, and as follows:

10. Vegetation, large shrubs, or trees that limit access or interfere with basin operation shall be pruned or removed.
11. Slope areas that have become bare shall be revegetated and eroded areas shall be regraded prior to being revegetated.
12. Grass shall be mowed to 4"-9" high and grass clippings shall be removed.
13. Fallen leaves and debris from deciduous plant foliage shall be raked and removed.
14. Invasive vegetation, such as Alligatorweed (*Alternanthera philoxeroides*), Halogeton (*Halogeton glomeratus*), Spotted Knapweed (*Centaurea maculosa*), Giant Reed (*Arundo donax*), Castor Bean (*Ricinus communis*), Perennial Pepperweed (*Lepidium latifolium*), and Yellow Starthistle (*Centaurea solstitialis*) must be removed and replaced with non-invasive species. Invasive species shall never contribute more than 25% of the vegetated area. For more information on invasive weeds, including biology and control of listed weeds, look at the encyclopedias located at the California Department of Food and Agriculture website- [http://www.cdfa.ca.gov/phpps/ipc/encycloweedia/encycloweedia\\_hp.htm](http://www.cdfa.ca.gov/phpps/ipc/encycloweedia/encycloweedia_hp.htm) or the California Invasive Plant Council website at [www.cal-ipc.org](http://www.cal-ipc.org).
15. Dead vegetation shall be removed if it exceeds 10% of area coverage. Vegetation shall be replaced immediately to maintain cover density and control erosion where soils are exposed.
16. For infiltration basins, sediment build-up exceeding 50% of the forebay capacity shall be removed. Sediment from the remainder of the basin shall be removed when 6 inches of sediment accumulates. Sediments shall be tested for toxic substance accumulation in compliance with current disposal requirements if land uses in the catchment include commercial or industrial zones, or if visual or olfactory indications of pollution are noticed. If toxic substances are encountered at concentrations exceeding thresholds of Title 22, Section 66261 of the California Code of Regulations, the sediment must be disposed of in a hazardous waste landfill and the source of the contaminated sediments shall be investigated and mitigated to the extent possible.
17. Following sediment removal activities, replanting and/or reseeding of vegetation may be required for reestablishment.

### ***Maintenance Standards***

A summary of the routine and major maintenance activities recommended for infiltration BMPs is shown in Table 6-35. Detailed routine and major maintenance standards are listed in Table 6-36 and Table 6-37.

**Table 6-35: Infiltration BMP Maintenance Quick Guide**

| <b>Inspection and Maintenance Activities Summary</b> |   |
|--|---|
| <b>Routine Maintenance</b>                           | <ul style="list-style-type: none"> <li>• Remove trash and debris as required</li> <li>• Repair and re-seed erosion near inlet if necessary</li> <li>• Remove any visual evidence of contamination from floatables such as oil and grease</li> <li>• Observation of drawdown times of BMP surface or within observation wells as applicable</li> <li>• Clean underdrain (if present) and outlet piping to alleviate ponding and restore infiltrative capacity.</li> <li>• Check for debris/sediment accumulation, rake surface and remove sediment (if any) and evaluate potential sources of sediment and debris</li> <li>• Remove minor sediment accumulation in pretreatment BMP and at the surface of the BMP, if applicable</li> <li>• Remove debris and obstructions near inlet and outlet structures as needed</li> <li>• Mow routinely to maintain ideal grass height and to suppress weeds</li> <li>• Periodically observe function under wet weather conditions</li> <li>• Photographs taken before and after maintenance is encouraged</li> </ul> |
| <b>Major Maintenance</b>                             | <ul style="list-style-type: none"> <li>• For basins, remove top layer of native soil to restore infiltrative capacity. Add soil amendments to promote infiltration</li> <li>• For trenches and drywells, remove top layer of pea gravel and sediment capture layer (i.e., sand and choking stone layer or geotextile fabric). If slow draining conditions persist, entire trench or dry well may need to be excavated and replaced.</li> <li>• For trenches and drywells, if a tear is found in the geotextile filter fabric, if applicable, repair or replace.</li> <li>• Facilities shall be inspected annually prior to the beginning of the wet season.</li> <li>• For infiltration basins, remove sediment when build-up exceeds 50% of the forebay capacity. Sediment from the remainder of the basin shall be removed when 6 inches of sediment accumulates.</li> <li>• Following sediment removal activities, replanting and/or reseeding of vegetation may be required for reestablishment.</li> </ul>   |

**Table 6-36: Routine Maintenance – Infiltration BMPs**

| Defect  | Conditions When Maintenance Is Needed   | Results Expected When Maintenance Is Performed   | Frequency   |
|---|---|--|---|
| Trash & Debris  | Any trash and debris which exceed 5 cubic feet per 1,000 square feet (one standard garbage can). In general, there shall be no visual evidence of dumping.<br>If less than threshold, all trash and debris will be removed as part of next scheduled maintenance. | Trash and debris cleared from site.  | Annually prior to wet season.<br>After major storm events (>0.75 in/24 hrs) if spot checks indicate widespread damage/ maintenance needs. |
| Inlet erosion   | Visible evidence of erosion occurring near inlet structures.  | Eroded areas repaired/reseeded   | Litter removal is dependent on site conditions and desired aesthetics and shall be done at a frequency to meet those objectives.          |
| Visual contaminants and pollution                       | Any evidence of oil, gasoline, contaminants or other pollutants.  | No contaminants or pollutants present.   |   |
| Slow drain time   | Standing water long after storm has passed (after 48 to 72 hours), or visual inspection of wells (if available) indicates that design drain times are not being achieved.   | Water drains within 48 to 72 hours. Drainage pipe is cleared, accumulated litter on surface is removed, and top 1-2" of pea gravel and sediment capture layer is replaced. |   |
| Inlets blocked  | Trash and debris or sediment blocking inlet structures.   | Inlets clear and free of trash and debris.   |   |
| Appearance of poisonous, noxious or nuisance vegetation | Excessive grass and weed growth. Noxious weeds, woody vegetation establishing, Turf growing over rock filter.   | Vegetation is mowed or trimmed to restore function. Weeds are removed to prevent noxious and nuisance plants from becoming established.                                    | Monthly (or as dictated by agreement between County and landscape contractor).  |

**Table 6-37: Major Maintenance – Infiltration BMPs**

| Defect                | Conditions When Maintenance Is Needed  | Results Expected When Maintenance Is Performed  | Frequency |
|-----------------------|--|---|-----------|
| Standing Water        | Standing water long after storm has passed (after 24 to 48 hours), or visual inspection of wells (if available) indicates that design drain times are not being achieved | Design infiltration rate restored, either through excavation and replacement of filter media or surface sediment removal. If applicable, underdrain cleaned, reset or replaced. | As needed |
| Tear in Filter Fabric | When there is a visible tear or rip in the filter fabric allowing water to bypass the fabric.  | Filter fabric repaired and/or replaced.   |           |
| Sediment Removal      | Sediment build-up in forebay exceeds 50% of the forebay capacity and/or 6 inches of accumulation in the basin.   | Sediment is removed, capacity of forebay and/or basin restored, and areas are replanted and/or reseeded as necessary to reestablish vegetation.                                 |           |

## 6.8 Permeable Pavement BMPs



**Figure 6-15: Permeable Pavers**

### 6.8.1 Description

Permeable pavements are alternatives to conventional impervious asphalts and concretes. However, permeable pavements allow water to pass through them into a subsurface gravel layer that doubles as a storage/infiltration area and a structural base layer. Where site conditions allow, the subsurface gravel layer (open-graded base/sub-base) is configured to allow water to infiltrate into the surrounding subsoil. If site conditions do not allow for infiltration, the water is detained in the gravel storage layer and then routed to a storm water conveyance system. In either case, the initial infiltration through the surface layers increases the time of concentration,  $T_c$ , provides some filtering of pollutants, and decreases the peak flows. Only when the water is allowed to infiltrate does it significantly decrease the runoff volume. Depending on the infiltration rate measured during the Soil Assessment (see Chapter 3) and the type of land use (i.e., hotspot areas), it may be necessary to install an impermeable liner around the base layer as well as an underdrain system. There are several styles of permeable pavement available, including those that are poured in place (i.e., porous concrete and porous asphalt), and modular paving systems (i.e., interlocking concrete, grass and gravel pavers).

#### *Pour in place permeable pavements*

Pour in place permeable pavements are poured where they will ultimately be used and allowed to setup (cure) in place. Typically, the pore spaces in the pavement make up about 10% of the total surface area. Porous asphalt and porous concrete are similar to each other in that the porosity is created by removing the small aggregate or fine particles from the conventional recipe, which leaves stable air pockets (gaps through the material) for water to drain through into the subsurface. Porous concrete is rougher than its conventional counterpart, and unlike oil-based asphalt will not release harmful chemicals into the environment. These types of

#### Applications

- Parking Lots & Driveways
- Low traffic roads
- Boat ramps
- Golf cart paths

#### Advantages

- Allows runoff to infiltrate into subsoil; groundwater recharge
- Easily integrated into existing infrastructure

#### Limitations

- Not ideal for high traffic areas
- Not suitable for stormwater hotspot sites
- Requires extensive maintenance

permeable pavements shall only be used in areas of slow and low traffic (e.g., parking lots, low traffic streets, pedestrian areas, etc.).

### ***Modular paving systems***

There are several varieties of pavers that allow for infiltration, including (but not limited to) interlocking concrete pavers, grass pavers, and gravel pavers. Typically, the pore spaces in the pavement make up about 10% of the total surface area. Interlocking concrete pavers are not porous themselves, rather the mechanism that allows them to interlock creates voids and gaps between the pavers that are filled with a pervious material and can withstand heavy loads. Grass and gravel pavers are nearly identical to each other in structure (rigid grid of concrete or durable plastic) but differ in their load bearing support capacities. The grids are embedded in the soil to support the loads that are applied, thereby preventing compaction, reducing rutting and erosion. Grass pavers are generally filled with a mix of sand, gravel, and soil to support vegetation growth (e.g., grass, low-growing groundcovers, etc.), which provides habitat, pollutant removal, and reduces storm water runoff volumes and rates. Grass pavers are good for low-traffic areas, while gravel pavers are good for high-frequency, low speed traffic areas. Gravel pavers differ from grass pavers in that they are filled with gravel (often underlain with a geotextile fabric to prevent the migration of the gravel into the subbase) which support greater loads and higher traffic volumes.

### ***6.8.2 Performance, Applicability, and Limitations***

Table 6-38 provides a summary of BMP performance, applicability, and limitations for permeable pavement areas. *It is important to note that information in these tables shall be used to provide general guidance for permeable pavement areas and shall not replace the evaluation performed by a water quality professional.*

### ***Applicability and Performance***

Table 6-38 and associated guidance provide general volume reduction capabilities and treatment effectiveness rankings for permeable pavement areas. Refer to Section 6.4 for the process that shall be used for selecting BMPs based on pollutants of concern. Refer to Table 6-1 to determine the ranking of permeable pavement BMPs for removal of pollutants of concern as compared with other storm water runoff BMPs provided in Chapter 6. Refer to Table 6-2 to assess the applicability of permeable pavement BMPs for your site based on site suitability considerations as compared with other storm water runoff BMPs provided in Chapter 6. Permeable pavement areas are volume-based BMPs intended, primarily, for water quality treatment and, depending on site slope and soil conditions, can provide high volume reduction (see Table 6-38). Where site conditions allow for infiltration (i.e., omitting underdrain), the volume reduction capability of permeable pavement areas can be used to meet the volume reduction requirement,  $V_{\text{reduction}}$ . In addition, for permeable pavement areas where underdrains are used with an impermeable liner, additional depth may be added to the subsurface gravel layer (open-graded base/sub-base) to provide additional storage and detention capacity. Permeable pavement areas can also be used to help meet the peak runoff discharge requirement. See Section 6.2 for specific storm water runoff requirements for Tier 3 projects.

**Table 6-38: Volume Reduction & Treatment Effectiveness for Permeable Pavement**

| Storm Water Runoff BMP   | Volume Mitigation (% of inflow) | Treatment Effectiveness for Pollutants of Concern <sup>1</sup> |           |          |  |          |  |
|--|---------------------------------|--|-----------|----------|--|----------|--|
|  |                                 | Trash  | Nutrients | Bacteria | Metals (particulate and dissolved fractions) | Sediment | Organics (hydrocarbons, oil, and grease) |
| Permeable Pavement   |                                 |  |           |          |  |          |  |
| Volume/Treatment Effectiveness: ● = Very High, ◐ = High, ◑ = Moderate, ◒ = Low, ○ = Very Low |                                 |  |           |          |  |          |  |

<sup>1</sup> Effectiveness may change based on design variations; standard BMP designs have been assumed.

Permeable pavement areas remove pollutants through physical, chemical, and biological mechanisms. Specifically, they use infiltration, absorption, microbial activity, plant uptake, sedimentation, and filtration. The subsurface gravel layer and subsoil beneath the facility (if designed for infiltration) adsorb pollutants to the aggregate and soil particles. In addition, biological degradation and chemical precipitation also lower pollutant concentrations. As the water filters through the permeable pavement layer, the subsurface gravel layer, and the subsoil, particulates and suspended solids are physically removed through filtration. The degree of infiltration, filtration, and adsorption in the subsoil is dictated by the soil type (i.e., clayey soils will adsorb and filter more pollutants than sandy soils, while sandy soils will infiltrate the water more quickly). The removal of nitrogen depends on the degree of infiltration into the subsoil where microbial activity can convert nitrogen. Vegetation that is present in grass pavers increases the amount of biological treatment by providing treatment within the structure itself. Other permeable pavement surfaces can also provide biological treatment within the structure itself and to different degrees depending on the level of pollutants in the source water and the permeable pavement type. Microbial bacteria will begin forming over time within the pavement pore spaces providing treatment as the water flows through.



**Site Suitability Recommendations and Limitations**

Table 6-39 and associated guidance provide general considerations for assessing a site's suitability for permeable pavement.

**Table 6-39: Site Suitability Considerations for Permeable Pavement**

| BMP                | Tributary (Site) Area (Acres) <sup>1</sup> | Site Slope (%)     | Depth to Seasonally High Groundwater Table (ft) | Hydrologic Soil Group                               | Horizontal Setback from Drinking Water Wells (ft) |
|--------------------|--|--------------------|---|---|---|
| Permeable Pavement | < 5 <sup>2</sup>                           | < 5 <sup>3,4</sup> | > 2 with underdrains; > 5 without underdrains   | Underdrains shall be provided for "C" and "D" soils | 100 <sup>5</sup>                                  |

<sup>1</sup> Tributary area is the area of the site draining to the BMP. Tributary areas provided here shall be used as a general guideline only. Tributary areas can be larger or smaller in some instances.

<sup>2</sup> Impervious surfaces draining to the BMP are limited to surfaces immediately adjacent to the permeable pavement, rooftop runoff, or other surfaces that do not contain significant sediment loads.

<sup>3</sup> If slope exceeds given limit or is within 200 feet from the top of a hazardous slope or landslide area, a geotechnical investigation is required.

<sup>4</sup> If a gravel base is used for storage of runoff: (1) slopes shall be restricted to 0.5% (steeper grades reduce storage capacity) and (2) underdrains shall be used if within 50 feet of a sensitive steep slope.

<sup>5</sup> Setbacks apply to systems without underdrains or systems underlain by "A" or "B" hydrologic soil groups.

Table 6-40 provides additional site applicability considerations for special design districts within the City including coastal bluff areas and hillside design districts.

**Table 6-40: Applicability of Permeable Pavement for Special Design Districts**

| Coastal Bluff Area  | Hillside Design District  |
|---|---|
| Acceptable if: (1) the facility is fully contained with an impermeable liner, underdrain system, and overflow to a storm water conveyance system, and (2) the site slope meets the criteria provided in Table 6-39. | Acceptable if: (1) a geotechnical investigation proves that the facility does not compromise the stability of the site slope or surrounding slopes, or (2) the facility is fully contained with an impermeable liner, underdrain system, and overflow to a storm water conveyance system. |

The following describes additional site suitability recommendations and limitations for permeable pavement.

- The tributary area (area draining to the permeable pavement) shall be less than 5 acre
- If located on a site with a slope greater than 2%, the permeable pavement area shall be terraced to prevent lateral flow through the subsurface
- If located in an area with soil infiltration rates less than 0.05 in/hr or greater than 2.4 in/hr, an underdrain shall be provided.

- Seasonal high groundwater table shall be at least 2 ft lower than the bottom of the permeable pavement system if underdrains area provided and 5 ft lower than the bottom of the permeable pavement system if underdrains are not provided.
- If no underdrains and no impermeable membrane, permeable pavement areas shall not be placed within 100 feet of a drinking water well or a structural foundation (upgradient), or within 10 feet of a structural foundation (downgradient).
- If underdrains are provided, site must have adequate relief between land surface and the storm water conveyance system to permit vertical percolation through the gravel drainage layer (open-graded base/sub-base) and underdrain to the storm water conveyance system.
- Shall not be located in hotspot areas where environmental releases may occur (e.g., commercial sites, gas stations).
- Permeable pavement located within 50 feet of a sensitive steep slope shall incorporate an underdrain. A geotechnical investigation and report must be provided to address the potential effects of infiltration on steep slopes if the permeable pavement area promotes infiltration (i.e., does not have underdrains) and is within 200 feet of the slope or mapped landslide area.
- Porous concrete and porous asphalt shall not be located in areas where sand tends to accumulate. Sand will clog the surface.
- Gravel-pave must be at least 200 feet from the street for driveways and parking areas preventing gravel from being displaced from vehicle tires onto streets. If the driveway or parking area is to be used for fire access, approval must be provided from the City fire department. Gravel-pave shall not be placed on walkways that are required to be handicap accessible.
- The type of pedestrian traffic shall be considered when determining which type of permeable pavement to use in a particular locations (e.g., pavers may not be a good option for locations where people will be walking wearing high heels)

### ***Multi-Use and Treatment Train Opportunities***

Permeable pavement areas can be applied in various settings, including:

- Individual lot driveways, walkways
- Parking lots, overflow parking lots
- Low-traffic roads
- High-traffic (with low speeds) roads/lots
- Golf cart paths
- Within right-of-ways along roads
- In parks and along open space edges

In addition, permeable pavement areas can be combined with other basic and storm water runoff BMPs to form a “treatment train” that can provide enhanced water quality treatment and reductions in runoff volume and rate. For example, overflow from permeable pavement can be directed to a vegetated swale or a bioretention area for further treatment, volume reduction, and, flow control. Both facilities can be reduced in size based upon demonstrated performance for meeting the storm water runoff requirements as outlined in Section 6.2 and addressing targeted pollutants of concern.

### 6.8.3 Design Criteria and Procedure

The main challenge associated with permeable pavement is sediment removal, which is critical to performance of this BMP. A schematic illustrating permeable pavement is provided in Figure 6-16.

Principal design criteria for permeable pavement are listed in Table 6-41.

**Table 6-41: Permeable Pavement Design Criteria**

| Design Parameter                              | Unit            | Design Criteria  |
|---|-----------------|--|
| Water quality design volume, $V_{wq}$         | ft <sup>3</sup> | See Section 6.2 and Appendix C for calculating $V_{wq}$ .  |
| Volume reduction requirement, $V_{reduction}$ | ft <sup>3</sup> | Only applicable for configurations that do not use underdrains.<br>See Section 6.2 and Appendix C for calculating $V_{reduction}$ .  |
| Pretreatment                                  | -               | Runoff from pervious areas shall be minimized but, if provided, a vegetated swale or filter strip shall be provided for all runoff from off-site sources that are not directly adjacent to the permeable pavement. |
| Drawdown time of gravel drainage layer        | hrs             | 72 (maximum)   |
| Minimum depth to bedrock                      | ft              | 3  |
| Minimum depth to seasonal high water table    | ft              | 2 (with underdrains); 5 (without underdrains)  |
| Maximum site slope                            | %               | 5  |
| Infiltration rate of subsoil                  | in/hr           | 0.05 (minimum); 2.4 (maximum)  |
| Underdrain                                    | -               | 6 inch minimum diameter; 0.5% minimum slope  |
| Overflow device                               | -               | Required   |

#### *Pretreatment*

1. Depending on how and where permeable pavement will be used, pretreatment of the runoff entering the pavement may be necessary. This is particularly important when the pavement will be accepting run-on from pervious areas or areas that are not completely stabilized. If this is the case, then the run-on shall be treated prior to contacting the permeable pavement. Without adequate pretreatment, the life of the permeable pavement may be significantly decreased.

2. If sheet flow is conveyed to the treatment area over stabilized grassed areas, the site must be graded in such a way that minimizes erosive conditions.

### *Geometry and Size*

1. Permeable pavement shall be sized to capture and treat the water quality design volume,  $V_{wq}$ . Where site conditions allow for infiltration, the permeable pavement may also be sized to infiltrate the volume reduction requirement,  $V_{reduction}$ . For permeable pavement designs that allow for partial infiltration (i.e., there is a permeable membrane between the gravel layer and subsoil), then 20% of the design detention volume,  $V_{detention}$ , of the subsurface gravel layer (open-graded base/sub-base) can be assumed to infiltrate allowing partial infiltration permeable pavement facilities to gain credit towards meeting the volume reduction requirement. See Section 6.2 and Appendix C for further detail.
2. Depth of each layer shall be determined by a licensed civil engineer based on analyses of not only the hydrology and hydraulics, but also the structural requirements of the site.
3. Permeable pavement (including the base layers) shall be designed to drain in less than 72 hours. Intent: Soils must be *allowed to dry out periodically in order to restore hydraulic capacity to receive flows from subsequent storms, maintain infiltration rates, maintain adequate sub soil oxygen levels for healthy soil biota, and to provide proper soil conditions for biodegradation and retention of pollutants.*

### *Sizing Methodology*

Permeable pavement shall be sized to capture and treat the water quality design volume,  $V_{wq}$ , and where site conditions allow, shall also be sized to infiltrate the volume reduction requirement,  $V_{reduction}$ . See Section 6.2 and Appendix C for specific sizing requirements and calculation methodologies. Procedures for sizing permeable pavement are summarized below. A permeable pavement sizing example is provided in Appendix D.

#### *Step 1: Calculate the volume required for sizing*

The volume required for sizing the subsurface gravel layer (open-graded base/sub-base) depends on whether the system will be designed for no infiltration, partial infiltration, or full infiltration:

1. **No infiltration** - If underdrains are required and no infiltration is acceptable into the subsoil (i.e., an impermeable membrane must be used), the volume of the gravel drainage layer shall be sized to accommodate the water quality design volume,  $V_{wq}$ .
2. **Partial infiltration** - If underdrains are required but partial infiltration is acceptable (i.e., a permeable membrane may be used and the soil type is of type B or C), the gravel drainage layer can be sized to accommodate the water quality design volume,  $V_{wq}$ , plus an additional 20% of  $V_{wq}$ . This would be advantageous if the volume reduction requirement,  $V_{reduction}$ , is greater than  $V_{wq}$  since it provides an additional credit towards meeting the volume reduction requirement. In this situation, it is assumed that 20% of the volume in the drainage layer will infiltrate into the subsoil rather than enter the underdrain and; therefore, a credit is given of  $0.2 * V_{wq}$  towards meeting the volume reduction requirement.

3. **Full infiltration** - If underdrains are not provided and infiltration is allowed, the design volume,  $V_{design}$ , is the larger of the water quality design volume,  $V_{wq}$ , and the volume reduction requirement,  $V_{reduction}$ .

*Step 2: If underdrains are incorporated, determine the required depth of the gravel drainage layer (open-graded base/sub-base). If underdrains will not be incorporated, skip to Step 3.*

If underdrains are incorporated, the gravel drainage layer may be designed depending on whether there is no infiltration or partial infiltration. If there is no infiltration,  $V_{design} = V_{wq}$ . If there is partial infiltration,  $V_{design} = V_{wq} + 0.2 * V_{wq}$ .

$$d_{min} = \frac{V_{design}}{A * n} \quad (\text{Equation 6-28})$$

Where:

- $d_{min}$  = minimum depth of gravel drainage layer (feet)
- $V_{design}$  = design volume of runoff to be treated/infiltrated (ft<sup>3</sup>)
- $n$  = gravel drainage layer porosity (unitless)
- $A$  = surface area of gravel drainage layer (ft<sup>2</sup>)

*Step 3: If underdrains will not be incorporated, calculate the design infiltration rate,  $k_{design}$ , of the native subsoil*

See the Bioretention Area Section 6.6.1 for the method used to determine the design infiltration rate of the native subsoil.

*Step 4: Sizing calculations for permeable pavement if no underdrains are incorporated.*

As with infiltration BMPs, permeable pavement can be sized using one of two methods: a simple sizing method or a routing modeling method. With either method, the runoff entering the facility must be completely infiltrated within 72 hours. Permeable pavement provides all of its storage in the voids of the gravel drainage layer (open-graded base/sub-base). The simple sizing procedure is described below. For the routing modeling method, refer to the Bioretention Area Section 6.6.1.

**Simple Method.** Determine the size of the required infiltrating surface by assuming the design runoff volume (i.e., all or part of the water quality design volume,  $V_{wq}$ , or the volume reduction requirement,  $V_{reduction}$ , whichever is larger) will fill the available void spaces based on the computed porosity of the gravel drainage layer media (normally about 32% for gravel).

Determine the maximum depth of runoff that can be infiltrated within the required drain time (72 hr) as follows:

$$d_{max} = \frac{k_{design}}{12} \times t \quad (\text{Equation 6-29})$$

Where:

- $t$  = required drain time (hrs) [Use 72 hours]
- $k_{design}$  = infiltration rate of native subsoil soils (in/hr)
- $d_{max}$  = the maximum depth of water that can be infiltrated within the required drain time (ft)

Choose the gravel drainage layer depth ( $l$ ) such that:

$$d_{max} \geq n \times l \quad (\text{Equation 6-30})$$

Where:

- $n$  = gravel drainage layer porosity (unitless)
- $l$  = depth of gravel drainage layer (ft)
- $d_{max}$  = the maximum depth of water that can be infiltrated within the required drain time (ft)

Calculate the infiltrating surface area (filter bottom area) required:

$$A = \frac{V_{design}}{\frac{Tk_{design}}{12} + nl} \quad (\text{Equation 6-31})$$

(Adapted from Georgia Stormwater Manual: <http://www.georgiastormwater.com/vol2/3-2-5.pdf>)

Where:

- $V_{design}$  = design volume of runoff to be infiltrated (ft<sup>3</sup>)
- $n$  = gravel drainage layer porosity (unitless)
- $k_{design}$  = design infiltration rate (in/hr)
- $l$  = depth of gravel drainage layer (ft)
- $T$  = fill time (time to fill infiltration BMP with water) (hrs) [use 2 hours for most designs]
- $A$  = surface area of gravel drainage layer (ft<sup>2</sup>)

### ***Permeable Pavement Material Layer***

This is the top layer and consists of either poured in place materials (i.e., porous concrete and porous asphalt), or modular paving materials (i.e., interlocking concrete, grass and gravel pavers). The thicknesses of these layers vary depending on design. Concrete pavers shall have a minimum thickness of 3 1/8".

***Bedding Course Layer***

1. A layer of smaller sized aggregate (e.g., No. 8) just under the permeable pavement provides a level surface for installing the permeable pavement and also acts as a filter to trap particles and help prevent the reservoir layer from clogging.
2. Bedding course layer is typically about 1.5" to 3" inches deep and may be underlain by a geotextile fabric or choking stone to prevent the smaller sized aggregate from migrating into the larger aggregate base layer.

***Geotextile Layer***

If a geotextile fabric is used, it must meet the minimum materials requirements shown in the table below.

| <b>Geotextile Property</b> | <b>Value</b>    | <b>Test Method</b> |
|----------------------------|-----------------|--------------------|
| Trapezoidal Tear (lbs)     | 40 (min)        | ASTM D4533         |
| Permeability (cm/sec)      | 0.2 (min)       | ASTM D4491         |
| AOS (sieve size)           | #60 - #70 (min) | ASTM D4751         |
| Ultraviolet resistance     | 70% or greater  | ASTM D4355         |

***Liner Layer***

Geomembrane liners shall have a minimum thickness of 30 mils.

***Subsurface Gravel Layer***

1. Must be designed to function as a support layer as well as a reservoir layer
  - a. Consideration must be given to the soil conditions as well as the expected loads
2. This layer may be divided into two layers, a filter layer that underlies the choking layer and a reservoir layer (typically washed, open-graded No. 57 aggregate without any fine sands)
3. If infiltration or partial infiltration is allowed, a geotextile fabric, choking stone, or both shall be placed on top of the subsurface gravel layer. If no infiltration is allowed, an impermeable liner shall surround the subsurface gravel layer. See above for typical specifications for each.
4. The subsurface gravel layer shall have zero slope (i.e., level).
5. The drawdown time for the subsurface gravel layer shall not exceed 72 hours.

***Underdrains***

If site conditions allow (i.e., soil infiltration rate and site slope are adequate), the volume reduction capability of permeable pavement areas can be enhanced by omitting the underdrain.

If underdrains are required, then they must meet the following criteria:

1. 6-inch minimum diameter.
2. Underdrains must be made of slotted, polyvinyl chloride (PVC) pipe conforming to ASTM D 3034 or equivalent or corrugated high density polyethylene (HDPE) pipe conforming to AASHTO 252M or equivalent. *Intent: As compared to round-hole perforated pipe, slotted underdrains provide greater intake capacity, clog resistant drainage, and reduced entrance velocity into the pipe, thereby reducing the chances of solids migration.*
3. Slotted pipe shall have 2 to 4 rows of slots cut perpendicular to the axis of the pipe or at right angles to the pitch of corrugations. Slots shall be 0.04 to 0.1-inch and shall have a length of 1-inch to 1.25-inch. Slots shall be longitudinally spaced such that the pipe has a minimum of one square inch per lineal foot.
4. Underdrains shall be sloped at a minimum of 0.5%.
5. Rigid non-perforated observation pipes with a diameter equal to the underdrain diameter shall be connected to the underdrain every 250 to 300 feet to provide a clean-out port as well as an observation well to monitor dewatering rates. The wells/cleanouts shall be connected to the perforated underdrain with the appropriate manufactured connections. The wells/cleanouts shall be placed flush with the pavement surface and shall be capped with a lockable screw cap. The ends of underdrain pipes not terminating in an observation well/cleanout shall also be capped.
6. The following aggregate gradation (i.e., drain rock) shall be used to provide a gravel blanket and bedding for the underdrain pipe. Place the underdrain on a 3-foot wide bed of the drain rock at a minimum thickness of 6 inches and cover with the same aggregate to provide a 1-foot minimum depth around the top and sides of the slotted pipe.

| Sieve size | Percent Passing |
|------------|-----------------|
| ¾ inch     | 100             |
| ¼ inch     | 30-60           |
| US No. 8   | 20-50           |
| US No. 50  | 3-12            |
| US No. 200 | 0-1             |

7. At the option of the designer, a geotextile fabric may be placed between the subsurface gravel layer and the drain rock although it is preferable to place the geotextile fabric between the permeable pavement material and the subsurface gravel layer for easier maintenance if the geotextile becomes clogged. If a geotextile fabric is used it must meet the minimum materials requirements as discussed above. Another option is to place a thin, 2- to 4-inch layer of pure sand and a thin layer (nominally two inches) of choking stone (such as #8) between the subsurface gravel layer and the drain rock.



8. The underdrain must drain freely to an acceptable discharge point. The underdrain can be connected to a downstream open conveyance (vegetated swale), to another bioretention cell as part of a connected treatment system, daylight to a vegetated dispersion area using an effective flow dispersion device, stored for reuse, or to a storm water conveyance system.

### ***Overflow***

An overflow mechanism is required. Two options are provided:

#### Option 1: Perimeter control

1. Flows in excess of the design capacity of the permeable pavement system will require an overflow system connected to a downstream conveyance or other storm water runoff BMP. In addition, if the pavement becomes clogged and infiltration decreases to the point that there is ponding, the runoff will migrate off of the pavement via overland flow instead of infiltrating into the subsurface gravel layer. There are several options for handling overflow using perimeter controls such as:
  - a. Perimeter vegetated swale
  - b. Perimeter bioretention
  - c. Storm drain inlets
  - d. Rock filled trench that funnels flow around pavement and into the subsurface gravel layer

#### Option 2: Overflow pipe(s)

1. A vertical pipe shall be connected to the underdrain.
2. The diameter, location, and quantity vary with design and shall be determined by a licensed civil engineer
3. Shall be located away from vehicular traffic.
4. May incorporate an observational and/or cleanout well.
5. Top of overflow pipe shall be covered with a screen fastened over the overflow inlet.

### ***6.8.4 Construction Considerations***

1. Permeable pavement shall be laid close to level, the bottom of the base layers must be level to ensure uniform infiltration.
2. Permeable pavement surfaces shall not be used to store site materials, unless the surface is well protected from accidental spillage or other contamination.
3. To prevent/minimize soil compaction in the area of the permeable pavement installation, use light equipment with tracks or oversized tires.

4. Divert storm water from the area as needed (before and during installation)
5. The pavement shall be the last installation done at a development site. Landscaping shall be completed and adjacent areas stabilized before pavement installation to minimize risk of clogging.
6. Vehicular traffic shall be prohibited for at least 2 days after installation.

Figure 6-16: Permeable Pavement Schematic

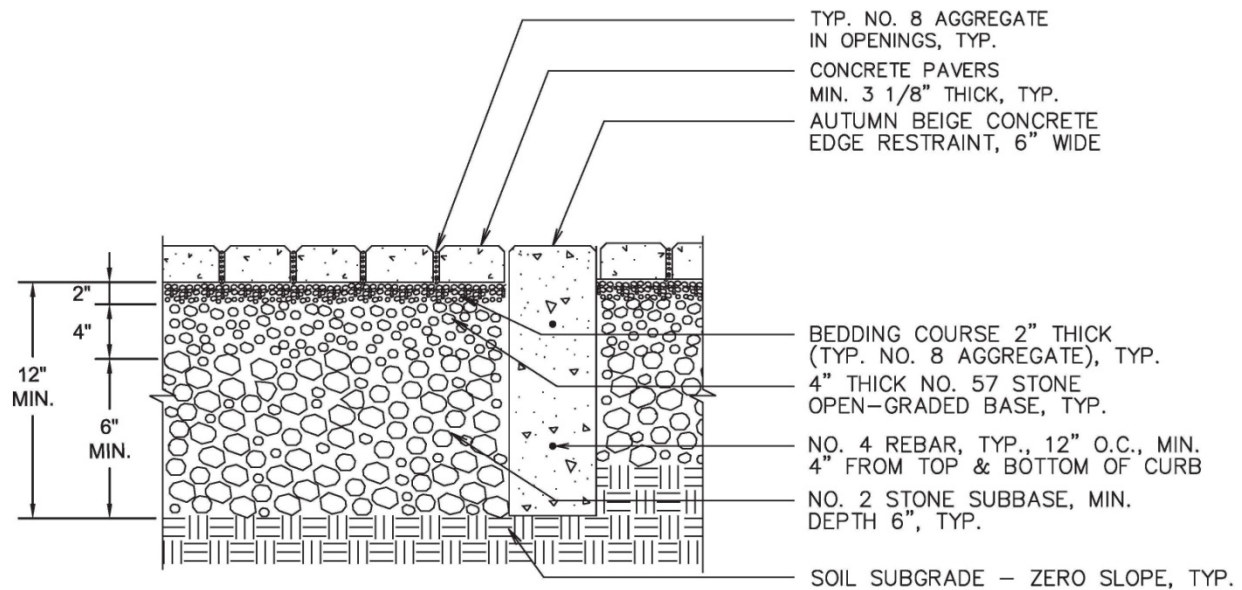

EDGE RESTRAINT SECTIONS  
N.T.S.

*All gravel base below the pavers is open graded, crushed aggregate. This means the gravel is not mixed with sand so there are open spaces between the rocks for water storage, and it is angular so the gravel pieces lock together once compacted. This design example uses a minimum 6" layer of No. 2 (2"-4") gravel sits on top of a level soil subgrade. On top of that is a 4" thick layer of No. 57 (1/4"-1") gravel. On top of that is a 2" layer of No. 8 aggregate (1/8"-1/2") which serves as a bedding layer for the permeable pavers. This No. 8 aggregate is also placed between the pavers.*

### ***6.8.5 Operations and Maintenance***

#### ***General Requirements***

Permeable pavement mainly requires vacuuming and management of adjacent areas to limit sediment contamination and prevent clogging by fine sediment particles; therefore, little special training is needed for maintenance crews. The following maintenance concerns and maintenance activities shall be considered and provided:

1. Trash tends to accumulate in paved areas, particularly in parking lots and along roadways. The need for litter removal shall be determined through periodic inspection.
2. Regularly (e.g., monthly for a few months after initial installation, then quarterly) inspect pavement for pools of standing water after rain events, this could indicate surface clogging.
3. Actively (3-4 times per year, or more frequently depending on site conditions) vacuum sweep the pavement to reduce the risk of clogging by frequently removing fine sediments before they can clog the pavement and subsurface layers; also, to help prolong the functional period of the pavement.
4. Inspect for vegetation growth on pavement and remove when present.
5. Inspect for missing sand/gravel in spaces between pavers and replace as needed.
6. Activities that lead to ruts or depressions on the surface shall be prevented or the integrity of the pavement shall be restored by patching or repaving. Examples are vehicle tracks and utility maintenance.
7. Spot clogging of porous concrete may be remedied by drilling 0.5" holes every few feet in the concrete.
8. Interlocking pavers that are damaged shall be replaced.
9. Maintain landscaped areas; reseed bare areas.

#### ***Maintenance Standards***

A summary of the routine and major maintenance activities recommended for permeable pavement is shown in Table 6-42. Detailed routine and major maintenance standards are listed in Table 6-43 and Table 6-44.

Table 6-42: Permeable Pavement Maintenance Quick Guide

| Inspection and Maintenance Activities Summary |   |
|---|---|
| <b>Routine Maintenance</b>                    | <ul style="list-style-type: none"> <li>• Clean area of trash and debris accumulations</li> <li>• Prevent the washing of soil onto the pavement</li> <li>• Clean area of sediments; vacuum sweep frequently (3-4 times/year)</li> <li>• Check that paving is draining properly</li> <li>• Maintain landscaped areas               <ul style="list-style-type: none"> <li>○ Seed bare areas</li> </ul> </li> <li>• Inspect outlets</li> </ul> |
| <b>Major Maintenance</b>                      | <ul style="list-style-type: none"> <li>• Restore infiltration rates caused by clogging</li> <li>• Repair any signs of deterioration, roughening, ruts or depressions</li> <li>• Sub-surface layers may require cleaning and/or replacing</li> </ul>   |

Table 6-43: Routine Maintenance – Permeable Pavement

| Defect                     | Conditions When Maintenance Is Needed          | Results Expected When Maintenance Is Performed | Frequency   |
|----------------------------|--|--|---|
| Sediment Accumulation      | Sediment is visible                            | Sediment deposits removed                      | Semi-annually, prior to wet season and after the wet season<br><br>After major storm events (>0.75 in/24 hrs) if spot checks indicate widespread damage/maintenance needs |
| Missing gravel/sand fill   | There are noticeable gaps in between pavers    | There are not gaps in between pavers           |   |
| Weeds/mosses filling voids | Vegetation is growing in/on permeable pavement | No vegetation growth                           |   |

| Defect   | Conditions When Maintenance Is Needed   | Results Expected When Maintenance Is Performed    | Frequency   |
|--|---|---|---|
| Trash and Debris Accumulation                    | Trash and debris accumulated on the permeable pavement.   | Trash and debris removed from permeable pavement. | Monthly or quarterly (or as dictated by agreement between City and landscape contractor)<br>Litter removal frequency is dependent on site conditions and desired aesthetics and shall be done at a frequency to meet those objectives |
| Dead or dying vegetation in adjacent landscaping | Vegetation is dead or dying leaving bare soil prone to erosion  | Vegetation is managed and soil is stabilized      |   |
| Surface clog                                     | Clogging is evidenced by ponding on the surface   | Well draining surface                             |   |
| Overflow clog                                    | <ul style="list-style-type: none"> <li>Excessive build up of water accompanied by observation of low flow in observation well (connected to underdrain system)</li> <li>If a surface overflow system is used, observation of an obvious clog</li> </ul> | Well draining system with adequate flow out       | Ongoing   |
| Visual contaminants and pollution                | Any visual evidence of oil, gasoline, contaminants or other pollutants.   | No visual contaminants or pollutants present.     |   |
| Erosion  | Tributary area <ul style="list-style-type: none"> <li>Exhibits signs of erosion</li> <li>Noticeably not completely stabilized</li> </ul>  | Tributary area completely stabilized              |   |

**Table 6-44: Major Maintenance – Permeable Pavement**

| Defect                       | Conditions When Maintenance Is Needed   | Results Expected When Maintenance Is Performed                                      | Frequency |
|------------------------------|---|---|-----------|
| Deterioration/<br>Roughening | Integrity of pavement is compromised (i.e., cracks, depressions, crumbling, etc.)                   | Smooth and even surface   | As needed |
| Subsurface<br>Clog           | Clogging is evidenced by ponding on the surface and is not remedied by addressing surface clogging. | Well draining system; excavation of pavement and gravel drainage layer is required. |           |

## 6.9 Building BMPs

### 6.9.1 Cistern/Rain barrel



**Figure 6-17: Typical Above Ground Cistern**

#### 6.9.1.1 Description

Cisterns are large rain barrels (Section 5.6). While rain barrels are less than 100 gallons, cisterns range from 100 to 10,000 gallons in capacity. Cisterns collect and temporarily store runoff from rooftops for later use as irrigation and/or other non-potable uses. The following components are required for installing and utilizing a cistern: (1) pipes that divert rooftop runoff to the cistern, (2) an over flow for when the cistern is full, (3) a pump, and (4) a distribution system to get the water to where it is intended to be used.

#### 6.9.1.2 Applicability, Performance, and Limitations

Cisterns come in a variety of materials, which shall be chosen based on its location (aboveground or underground) and the size required.

##### *Applicability and Performance*

Building BMPs are generally intended for achieving volume reduction and flow control of roof drainage. Depending on the rate of water use from the cistern, it may be emptied, remain full, or be somewhere between empty and full when the next storm event takes place. It is only effective for volume reduction if the cistern is emptied between storm events. In most cases, it is not practical to capture all of the water quality treatment volume,  $V_{wq}$ , or volume reduction requirement,  $V_{reduction}$ , using cisterns as they would be impractically large. Treatment effectiveness of cisterns (and other building BMPs) are not comparable to other BMPs in Chapter 6 that treat runoff from a wide range of impervious surfaces that generally have higher pollutant concentrations than cisterns which mainly capture roof runoff. In general, cisterns

#### Applications

- Any type of land use, provided adequate end use of water
- Collect rooftop runoff

#### Advantages

- Volume & peak flow reduction
- Collects stormwater for alternative on-site uses

#### Limitations

- Only treat rooftop runoff
- Must be monitored regularly to ensure that there is adequate storage capacity
- Regulatory obstacles may limit reuse opportunities



provide little pollutant reduction although irrigation of stored roof runoff may have nutrients and small amounts of metals which may be used by the vegetation or adsorbed by soil particles.

**Site Suitability Recommendations and Limitations**

Table 6-45 and associated guidance provide general considerations for assessing a site’s suitability for cisterns.

**Table 6-45: Site Suitability Considerations for Cisterns**

| <b>BMP</b>          | <b>Tributary Area (Acres; Sq.Ft.)<sup>1</sup></b> | <b>Site Slope (%)</b> | <b>Depth to Seasonally High Groundwater Table (ft)</b> | <b>Hydrologic Soil Group</b> | <b>Horizontal Setback from Drinking Water Wells (ft)</b> |
|---------------------|---|-----------------------|--|------------------------------|--|
| Cistern/Rain Barrel | Depends on system size                            | Any                   | > 2 if tank is underground                             | Any                          | N/A  |

<sup>1</sup> Tributary area is the area of the site draining to the BMP. Tributary areas provided here shall be used as a general guideline only. Tributary areas can be larger or smaller in some instances.

Table 6-46 provides additional site applicability considerations for special design districts within the City including coastal bluff areas and hillside design districts.

**Table 6-46: Applicability of Cisterns for Special Design Districts**

| <b>Coastal Bluff Area</b>   | <b>Hillside Design District</b>   |
|---|---|
| Acceptable if a geotechnical investigation is provided to ensure that the facility does not compromise the stability of the site slope or surrounding slopes. If the stored rain water is to be used for irrigation, City staff will determine how much (if any) water application to the bluff is appropriate. | Acceptable if a geotechnical investigation is provided to ensure that the facility does not compromise the stability of the site slope or surrounding slopes. If the stored rain water is to be used for irrigation, City staff will determine how much (if any) water application to the sloped property is appropriate. |

The following describes additional site suitability recommendations for cisterns.

- Shall not be located on uneven or sloped surfaces.
- If installed on a sloped surface, the base where the cistern will be installed shall be leveled prior to installation.
- Shall be secured in place.

**Multi-Use and Treatment Train Opportunities**

A cistern can be combined into a treatment train to provide enhanced water quality treatment and reductions in runoff volume and rate. For example, if a green roof is placed upgradient of a cistern, the rate and volume of water flowing to the cistern can be reduced and the water quality enhanced. Each facility can be reduced in size accordingly based upon demonstrated performance for meeting the storm water runoff requirements as outlined in Section 6.2 and

addressing targeted pollutants of concern. In addition, cisterns can be incorporated into the landscape design of a site and can be aesthetically pleasing as well as functional.

### **6.9.1.3 Design Criteria and Procedure**

Cisterns shall be designed according to the current requirements of the City of Santa Barbara and the Santa Barbara County Flood Control and Water Conservation District.

#### ***Cistern Sizing***

In most cases, it is not practical to capture all of the water quality treatment volume,  $V_{wq}$ , or volume reduction requirement,  $V_{reduction}$ , using cisterns as they would be impractically large. Cisterns are intended to capture and store runoff for use later. However, the effectiveness of a cistern for reducing runoff volumes and peaks depends on the cisterns effective storage capacity (i.e., the volume available for storage at the beginning of each event). Therefore, the size required varies based, not only on precipitation, but also usage. Cisterns may be operated in different configurations as discussed in the rain barrel section (Section 5.6). Due to the intricacies involved in considering a variable storage capacity, cisterns may only be sized to meet the volume reduction requirement using a continuous simulation model with a long-term precipitation record.

### **6.9.1.4 Construction Considerations**

The foundation housing the cistern must be adequate to support the weight of the cistern and the water it will store.

**6.9.1.5 Operations and Maintenance**

*General Requirements*

1. Inspect cisterns, associated pipes, and valve connections for leaks.
2. Clean gutters and filters of debris that has accumulated and is obstructing flow into the cistern.
3. Clean and remove accumulated sediment annually.
4. Check cistern for stability and anchor if necessary.
5. Slopes in the vicinity of the cistern shall be stabilized and planted using appropriate erosion control measures when native soil is exposed or erosion channels are forming.
6. The cistern shall be well maintained; trash and debris, sediment, visual contamination (e.g., oils), and noxious or nuisance weeds shall all be removed.
7. If cistern is underground, ensure that manhole is accessible, operational, and secure.

*Maintenance Standards*

A summary of the routine and major maintenance activities recommended for cistern filters is shown in Table 6-47.

**Table 6-47: Cistern Maintenance Quick Guide**

| <b>Inspection and Maintenance Activities Summary</b> |   |
|--|---|
| <b>Routine Maintenance</b>                           | <ul style="list-style-type: none"> <li>• Remove sediment and debris accumulation near inlet and outlet structures</li> <li>• Trash and debris removal</li> <li>• Remove any evidence of visual contamination from floatables such as oil and grease</li> <li>• Check cistern stability, anchor if necessary</li> <li>• Stabilize/repair minor erosion and scouring with gravel</li> <li>• Photographs taken before and after maintenance is encouraged</li> </ul> |
| <b>Major Maintenance</b>                             | <ul style="list-style-type: none"> <li>• Replace broken screens, spigots, valves, level sensors, etc.</li> <li>• Repair or replace damaged cistern</li> </ul>   |

### 6.9.2 Planter Box



**Figure 6-18: Planter Box**

*Photo Credit: The Low Impact Development Center*

#### 6.9.2.1 Description

Planter boxes, either elevated or at ground level, are designed to capture and temporarily store storm water runoff. Planter boxes are comprised of a variety of materials (usually chosen to be the same material as the adjacent building or sidewalk). The boxes are filled with gravel on the bottom (to house the underdrain system), planting soil media, and vegetation. Planter boxes may also require splash blocks for flow energy dissipation and geotextile filter fabric or choking stone to reduce clogging of the underdrain system. The storm water infiltrates into the soil where it is used by the plants, stored and filtered, if the runoff volume is large the storm water may even pond on the surface for a limited period of time. Planter boxes are intended to be placed next to buildings and installed with underdrains and an impervious liner. Once the soil becomes saturated, the excess water collects in the underdrain system where it may be routed to a storm water conveyance system or another storm water runoff BMP, such as a vegetated swale filter. Planter boxes are very similar in design to bioretention areas (see Section 6.6.1 for additional information) but are more practical for steep slope applications where the planter boxes can be terraced.

#### 6.9.2.2 Applicability, Performance, and Limitations

Planter boxes are uniquely suited for redevelopment in urban areas. In addition, planter boxes are suitable for sites where infiltration practices are impractical or discouraged. Planter boxes are often designed to capture runoff from rooftop downspouts of commercial, industrial, and residential structures and offer peak discharge rate reduction and moderate volume reduction of roof drainage via evapotranspiration.

#### Applications

- Commercial, institutional, and residential
- Most commonly used in urban areas adjacent to buildings and sidewalks

#### Advantages

- Combines stormwater treatment with runoff conveyance
- Volume & peak flow reduction
- Pollutant removal
- Does not require a setback from building foundation

#### Limitations

- May require additional support on steep slopes
- Must be constructed with underdrain system to convey excess water to stormwater conveyance system

**Applicability and Performance**

Building BMPs are generally intended for reducing peak runoff discharge rates and providing volume reduction of roof drainage. While planter boxes do provide water quality treatment, treatment effectiveness of planter boxes (and other building BMPs) are not comparable to other storm water runoff BMPs in Chapter 6 that treat runoff from a wide range of impervious surfaces that generally have higher pollutant concentrations. If planter boxes are placed adjacent to a building, the area between the building foundation and the planter will need to be waterproofed so that the foundation is not compromised.

**Site Suitability Recommendations and Limitations**

Table 6-48 and associated guidance provide general considerations for assessing a site's suitability for planter boxes.

**Table 6-48: Site Suitability Considerations for Planter Boxes**

| BMP         | Tributary Area (Acres; Sq.Ft.) <sup>1</sup> | Site Slope (%)    | Depth to Seasonally High Groundwater Table (ft) | Hydrologic Soil Group | Horizontal Setback from Drinking Water Wells (ft) |
|-------------|---|-------------------|---|-----------------------|---|
| Planter Box | 0.35 Acres; 15,000 Sq.Ft.                   | < 15 <sup>4</sup> | > 2   | Any                   | N/A   |

<sup>4</sup> If system is fully contained and includes a liner, underdrain system, and overflow to a storm water conveyance system, then slopes can exceed 15%.

Table 6-49 provides additional site applicability considerations for special design districts within the City including coastal bluff areas and hillside design districts.

**Table 6-49: Applicability of Planter Boxes for Special Design Districts**

| Coastal Bluff Area  | Hillside Design District  |
|---|---|
| Acceptable if: (1) the facility is fully contained with an impermeable liner, underdrain system, and overflow to a storm water conveyance system, and (2) the site slope meets the criteria provided in Table 6-48. | Acceptable if: (1) the facility is fully contained with an impermeable liner, underdrain system, and overflow to a storm water conveyance system, and (2) the site slope meets the criteria provided in Table 6-48. |

The applicability of planter box areas is limited by the following site characteristics:

- The tributary area (area draining to the planter box area) shall be less than 15,000 sq. ft.
- Groundwater levels shall be at least 2 ft lower than the bottom of the planter box area
- Site must have adequate relief between land surface and the storm water conveyance system to permit vertical percolation through the planting media and underdrain to the storm water conveyance system
- Shall not be located in areas with excessive shade to avoid poor vegetative growth. For moderately shaded areas, shade tolerant plants shall be used.

- Shall not be located near large trees that may drop leaves or needles. Excessive tree debris may smother the grass or impede the flow through the swale.

### ***Multi-Use and Treatment Train Opportunities***

A planter box can be used in a treatment train to provide enhanced water quality treatment and reductions in runoff volume and rate. For example, if a planter box is placed upgradient of a cistern, the rate and volume of water flowing to the cistern can be reduced and the water quality enhanced. As another example, a planter box could be placed downstream of a downspout that drains the green roof. In both cases, each facility can be reduced in size accordingly based upon demonstrated performance for meeting the storm water runoff requirements as outlined in Section 6.2 and addressing targeted pollutants of concern. In addition, planter boxes can be incorporated into the landscape design of a site and can be aesthetically pleasing as well as functional.

#### **6.9.2.3 Design Criteria and Procedure**

Planter boxes shall be designed according to the current requirements of the City of Santa Barbara and the Santa Barbara County Flood Control and Water Conservation District. Standard design criteria for planter boxes are listed in Table 6-50. A planter box schematic is illustrated in

**Table 6-50: Planter Box Design Criteria**

| <b>Design Parameter</b>                       | <b>Unit</b>     | <b>Design Criteria</b>  |
|---|-----------------|---|
| Water quality design volume, $V_{wq}$         | ft <sup>3</sup> | See Section 6.2 and Appendix C for calculating $V_{wq}$ .   |
| Volume reduction requirement, $V_{reduction}$ | ft <sup>3</sup> | See Section 6.2 and Appendix C for calculating $V_{reduction}$ .  |
| Drawdown time of planting soil                | hrs             | 48  |
| Maximum ponding depth                         | inches          | 12  |
| Planting soil depth                           | feet            | 2; 3 preferred  |
| Stabilized mulch depth                        | inches          | 2 to 3  |
| Planting media composition                    | -               | 60 to 70% sand, 15 to 25% compost, and 10 to 20% clean topsoil; organic content 8 to 12%; pH 5.5 to 7.5 |
| Underdrain                                    | -               | 6 inch. minimum diameter; 0.5% minimum slope  |
| Overflow device                               | -               | Required  |

### ***Geometry and Size***

1. Planter boxes areas shall be sized to capture and treat the water quality design volume,  $V_{wq}$ , with a 12-inch maximum ponding depth. See Section 6.2 and Appendix C for further detail on the storm water runoff requirements and associated calculations.
2. Planting soil depth shall be a minimum of 2 feet, although 3 feet is preferred. *Intent: The planting soil depth shall provide a beneficial root zone for the chosen plant palette and*

*adequate water storage for the water quality design volume. A deeper planting soil depth will provide a smaller surface area footprint.*

3. Planter boxes shall be designed to drain to below the planting soil depth in less than 48 hours. Intent: Soils must be *allowed to dry out periodically in order to restore hydraulic capacity to receive flows from subsequent storms, maintain infiltration rates, prevent long periods of saturation for plant health, maintain adequate soil oxygen levels for healthy soil biota and vegetation, reduce potential for vector breeding, and to provide proper soil conditions for biodegradation and retention of pollutants.*

### ***Sizing Methodology***

Planter boxes are sized the same as bioretention areas with underdrains using parameters appropriate for planter boxes. See the Bioretention Area Section 6.6.1 for appropriate sizing calculations and the bioretention area sizing example in Appendix D.

### ***Flow Entrance and Energy Dissipation***

The following types of flow entrance can be used for planter boxes:

1. Pipe flow entrance: Piped entrances, such as roof downspouts, shall include rock, splash blocks, or other erosion protection material at the entrance to dissipate energy and disperse flows.
2. Woody plants (e.g., trees, shrubs, etc.) can restrict or concentrate flows and can be damaged by erosion around the root ball and shall not be placed directly in the entrance flow path.

### ***Underdrains***

If underdrains are required, then they must meet the following criteria:

1. 6-inch minimum diameter.
2. Underdrains must be made of slotted, polyvinyl chloride (PVC) pipe conforming to ASTM D 3034 or equivalent or corrugated high density polyethylene (HDPE) pipe conforming to AASHTO 252M or equivalent. *Intent: As compared to round-hole perforated pipe, slotted underdrains provide greater intake capacity, clog resistant drainage, and reduced entrance velocity into the pipe, thereby reducing the chances of solids migration.*
3. Slotted pipe shall have 2 to 4 rows of slots cut perpendicular to the axis of the pipe or at right angles to the pitch of corrugations. Slots shall be 0.04 to 0.1-inch and shall have a length of 1-inch to 1.25-inch. Slots shall be longitudinally spaced such that the pipe has a minimum of one square inch per lineal foot.
4. Underdrains shall be sloped at a minimum of 0.5%.
5. Rigid non-perforated observation pipes with a diameter equal to the underdrain diameter shall be connected to the underdrain every 250 to 300 feet to provide a clean-out port as well as an observation well to monitor dewatering rates. The wells/cleanouts shall be

connected to the perforated underdrain with the appropriate manufactured connections. The wells/cleanouts shall extend 6 inches above the top elevation of the planter box mulch, and shall be capped with a lockable screw cap. The ends of underdrain pipes not terminating in an observation well/cleanout shall also be capped.

- The following aggregate shall be used to provide a gravel blanket and bedding for the underdrain pipe. Place the underdrain on a 3-foot wide bed of the aggregate at a minimum thickness of 6 inches and cover with the same aggregate to provide a 1-foot minimum depth around the top and sides of the slotted pipe.

| Sieve size | Percent Passing |
|------------|-----------------|
| ¾ inch     | 100             |
| ¼ inch     | 30-60           |
| US No. 8   | 20-50           |
| US No. 50  | 3-12            |
| US No. 200 | 0-1             |

- At the option of the designer, a geotextile fabric may be placed between the planting media and the drain rock. If a geotextile fabric is used it must meet the following minimum materials requirements. Another option is to place a thin, 2- to 4-inch layer of pure sand and a thin layer (nominally two inches) of choking stone (such as #8) between the planting media and the drain rock.

| Geotextile Property    | Value           | Test Method |
|------------------------|-----------------|-------------|
| Trapezoidal Tear (lbs) | 40 (min)        | ASTM D4533  |
| Permeability (cm/sec)  | 0.2 (min)       | ASTM D4491  |
| AOS (sieve size)       | #60 - #70 (min) | ASTM D4751  |
| Ultraviolet resistance | 70% or greater  | ASTM D4355  |

- The underdrain must drain freely to an acceptable discharge point. The underdrain can be connected to a downstream open conveyance (vegetated swale), to a planter box cell as part of a connected treatment system, stored for reuse, or to a storm water conveyance system.

**Overflow**

An overflow device is required to be set at 2" below the top of the planter. The most common option is a vertical riser, described below.

Vertical riser

- A vertical PVC pipe (SDR 35) shall be connected to the underdrain.



2. The overflow riser(s) shall be 6 inches or greater in diameter, so it can be cleaned without damage to the pipe. The vertical pipe will provide access to cleaning the underdrains.
3. The inlet to the riser shall be 6 inches above the planting media, and be capped with a spider cap.

***Hydraulic Restriction Layers***

Infiltration pathways need to be restricted due to the close proximity of foundations. Three types of restricting layers can be incorporated into planter box designs:

1. Filter fabric can be placed along vertical walls to reduce lateral flows.
2. Clay (bentonite) liners can be used. If so, underdrain system is also required.
3. Geomembrane liners shall have a minimum thickness of 30 mils.

***Planting/Storage Media***

1. The planting media placed in the cell shall be highly permeable and high in organic matter (e.g., loamy sand mixed thoroughly with compost amendment) and a surface mulch layer.
2. Planting media shall consist of 60 to 70% sand, 15 to 25% compost, and 10 to 20% clean topsoil. The organic content of the soil mixture shall be 8% to 12%; the pH range shall be 5.5 to 7.5.
3. Sand shall be free of stones, stumps, roots or other similar objects larger than 5 millimeters, and have the following gradation:

| Particle Size (ASTM D422) | % Passing |
|---------------------------|-----------|
| #4                        | 100       |
| #6                        | 88-100    |
| #8                        | 79-97     |
| #50                       | 11-35     |
| #200                      | 5-15      |

4. Compost shall be free of stones, stumps, roots or other similar objects larger than ¾ inches; have a particle size of 98% passing through ¾" screen or smaller; and meet the following characteristics:
  - Soluble Salt Concentration: < 10 mmhos/cm (dS/m)
  - pH: 5.0-8.5
  - Moisture: 30-60% wet weight basis
  - Organic Matter: 30-65% dry weight basis
  - Stability (Carbon Dioxide evolution rate): >80% relative to positive control
  - Maturity (Seed emergence and seedling vigor): >80% relative to positive control

- Physical contaminants: < 1% dry weight basis
5. Topsoil shall be free of stones, stumps, roots or other similar objects larger than 2 inches, and have the following characteristics:

- Soluble salts: < 4.0 mmhos/cm (dS/m)
- pH range: 5.5 to 7.0
- Organic matter: > 5%
- Carbon to Nitrogen Ratio: < 20:1
- Moisture content: 25-55%

| Particle Size (ASTM D422, D1140) | % Passing |
|----------------------------------|-----------|
| 3/4"                             | 98        |
| Sand (0.05 - 2.0 mm )            | 50-75     |
| Silt (0.002 - 0.05 mm)           | 15-40     |
| Clay                             | < 5       |

6. The planter box area shall be covered with mulch when constructed and annually replaced to maintain adequate mulch depth. *Intent: this will help sustain nutrient levels, suppress weeds, and maintain infiltrative capacity.* Mulch shall be:

- Well-aged, shredded or chipped woody debris or plant material. Well-aged mulch is defined as mulch that has been stockpiled or stored for at least twelve (12) months. Compost meeting the requirements above may also be used (compost is less likely to float and is a better source for organic materials).
- Free of weed seeds, soil, roots, and other material that is not bole or branch wood and bark.
- Mulch depth shall be 2 to 3 inches thick (*intent: thicker applications can inhibit proper oxygen and carbon dioxide cycling between the soil and atmosphere*).
- Grass clippings or pure bark shall not be used as mulch.

7. Planting media design height shall be marked appropriately, such as a collar on the vertical riser (if installed), or with a stake inserted 2 feet into the planting media and notched to show planter box surface level and ponding level.

8. The planter box soil mix shall be tested and meet the following criteria:

| Item  | Criteria              | Test Method |
|---|-----------------------|-------------|
| Corrected pH  | 5.5 – 7.5             | ASTM D4972  |
| Magnesium   | Minimum 32 ppm        | *           |
| Phosphorus (Phosphate - P <sub>2</sub> O <sub>5</sub> ) | Not to exceed 69 ppm  | *           |
| Potassium (K <sub>2</sub> O)                            | Minimum 78 ppm        | *           |
| Soluble Salts   | Not to exceed 500 ppm | *           |

\* Use authorized soil test procedures.

Should the pH fall outside of the acceptable range, it may be modified with lime (to raise) or iron sulfate plus sulfur (to lower). The lime or iron sulfate must be mixed uniformly into the soil mix prior to use in planter boxes.

Should the soil mix not meet the minimum requirement for magnesium, it may be modified with magnesium sulfate. Likewise, should the soil mix not meet the minimum requirement for potassium, it may be modified with potash. Magnesium sulfate and potash must be mixed uniformly into the soil mix prior to use in planter boxes.

Limestone. Limestone shall contain not less than 85 percent calcium and magnesium carbonates. Dolomitic (magnesium) limestone shall contain at least 10 percent magnesium as magnesium oxide and 85 percent calcium and magnesium carbonates.

Limestone shall conform to the following gradation:

| Sieve Size | Minimum Percent Passing By Weight |
|------------|-----------------------------------|
| No. 10     | 100                               |
| No. 20     | 98                                |
| No. 100    | 50                                |

Iron Sulfate. Iron sulfate shall be a constituent of an approved horticultural product produced as a fertilizer for supplying iron and as a soil acidifier.

Magnesium Sulfate. Magnesium sulfate shall be a constituent of an approved horticultural product produced as a fertilizer.

Potash. Potash (potassium oxide) shall be a constituent of an approved horticultural product produced as a fertilizer.

### ***Vegetation***

Planter box vegetation shall have the following characteristics:

1. Plant materials shall be tolerant of summer drought, ponding fluctuations, and saturated soil conditions for 48 to 72 hours.
2. It is recommended that a minimum of three tree, three shrubs, and three herbaceous groundcover species be incorporated to protect against facility failure due to disease and insect infestations of a single species. Plant rooting depths shall not damage the underdrain. Slotted or perforated underdrain pipe shall be more than 5 feet from tree locations (if space allows).
3. Native plant species and/or hardy cultivars that are not invasive and do not require chemical inputs shall be used to the maximum extent practicable.

4. Shade trees shall have a single main trunk. Trunks shall be free of branches below the following heights:

| Caliper (in)   | Height (ft) |
|----------------|-------------|
| 1-1/2 to 2-1/2 | 5           |
| 3              | 6           |

5. See Appendix G for a recommended native plant list for planter boxes, a list of local nurseries where these plants can be purchased, and a list of local and regional on-line resources. The plant list shall be used as a guide only and shall not replace project-specific planting recommendations provided by a landscape professional including recommendations on appropriate plants, fertilizer, mulching applications, and irrigation requirements (if any) to ensure healthy vegetation growth. See Section 5.11 for more information on landscaping/planting recommendations and Section 5.10 for more information on soil amendment recommendations.

**6.9.2.4 Construction Considerations**

1. The use of treated wood or galvanized metal anywhere inside the facility is prohibited.
2. Material of planter boxes shall be selected carefully to blend in and enhance aesthetics of adjacent structures (buildings and sidewalks).
3. Plants shall be selected carefully to minimize maintenance and function properly.

**Figure 6-19: Planter Box Schematic**

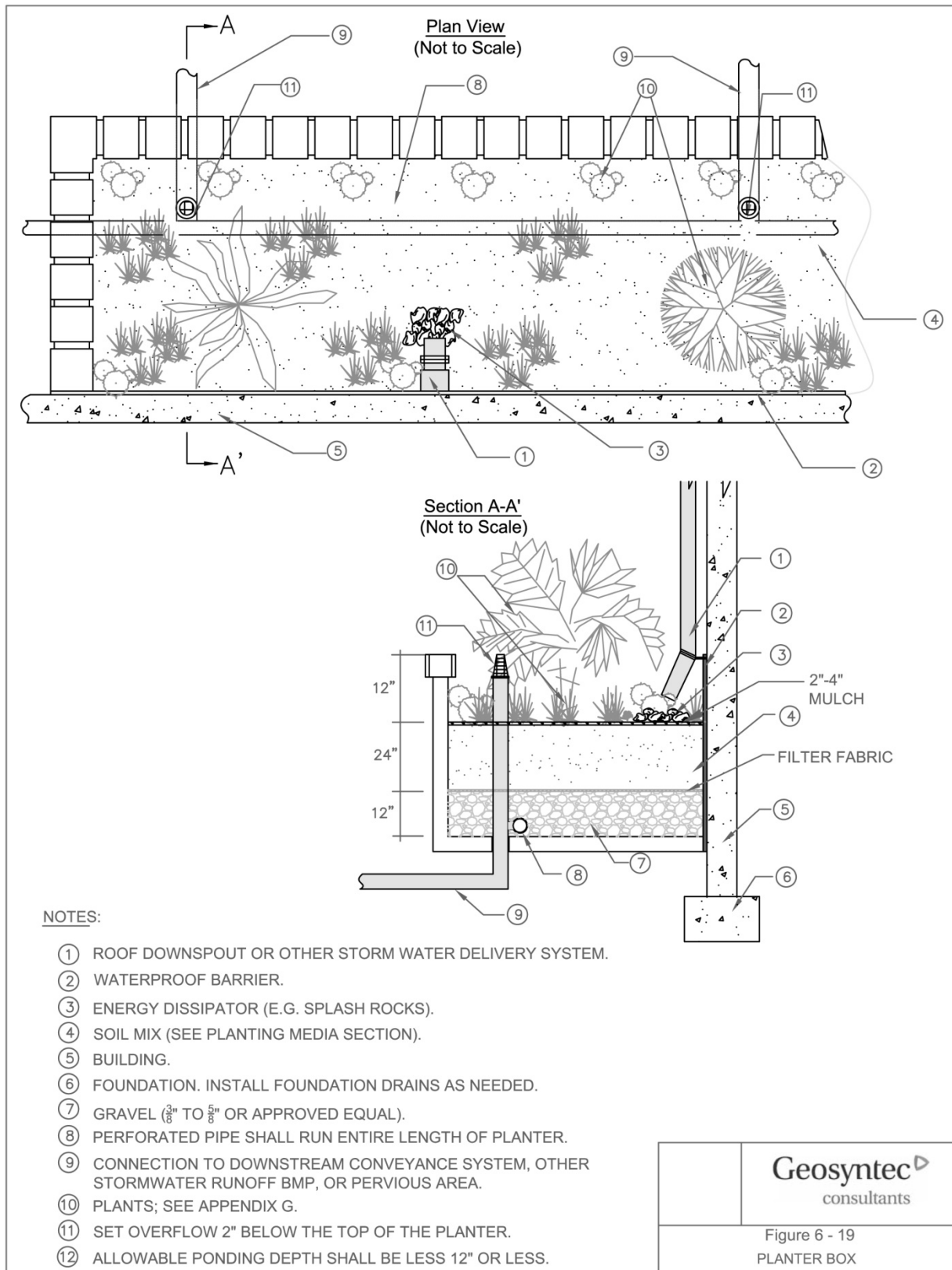

### 6.9.2.5 Operations and Maintenance

#### *General Requirements*

Planter boxes require annual plant, soil, and mulch layer maintenance to ensure optimum infiltration, storage, and pollutant removal capabilities. In general, planter box maintenance requirements are typical of landscape care procedures and include:

1. Watering: Plants shall be selected to be drought tolerant and do not require watering after establishment (2 to 3 years). Watering may be required during prolonged dry periods after plants are established.
2. Erosion control: Inspect flow entrances, ponding area, and surface overflow areas periodically, and replace soil, plant material, and/or mulch layer in areas if erosion has occurred (see Appendix H for an inspection and maintenance checklist, use the checklist for bioretention areas). Properly designed facilities with appropriate flow velocities shall not have erosion problems except perhaps in extreme events. If erosion problems occur, the following shall be reassessed: (1) flow velocities and gradients within the cell, and (2) flow dissipation and erosion protection strategies in the flow entrance. If sediment is deposited in the planter box, immediately determine the source within the contributing area, stabilize, and remove excess surface deposits.
3. Plant material: Depending on aesthetic requirements, occasional pruning and removing of dead plant material may be necessary. Replace all dead plants and if specific plants have a high mortality rate, assess the cause and, if necessary, replace with more appropriate species. Periodic weeding is necessary until plants are established. The weeding schedule shall become less frequent if the appropriate plant species and planting density have been used and, as a result, undesirable plants excluded.
4. Nutrients and pesticides: The soil mix and plants are selected for optimum fertility, plant establishment, and growth. Nutrient and pesticide inputs should not be required and may degrade the pollutant processing capability of the planter box area, as well as contribute pollutant loads to receiving waters. By design, planter boxes are located in areas where phosphorous and nitrogen levels are often elevated and these should not be limiting nutrients. If in question, have soil analyzed for fertility.
5. Mulch: Replace mulch annually in planter boxes where heavy metal deposition is likely (e.g., contributing areas that include industrial, auto dealer/repair, parking lots, and roads). In residential lots or other areas where metal deposition is not a concern, replace or add mulch as needed to maintain a 2 to 3 inch depth at least once every two years.
6. Soil: Soil mixes for planter boxes are designed to maintain long-term fertility and pollutant processing capability. Estimates from metal attenuation research suggest that metal accumulation should not present an environmental concern for at least 20 years in planter boxes. Replacing mulch in planter boxes where heavy metal deposition is likely provides an additional level of protection for prolonged performance. If in question, have soil analyzed for fertility and pollutant levels.

***Maintenance Standards***

A summary of the routine and major maintenance activities recommended for planter boxes is shown in Table 6-51. Detailed routine and major maintenance standards are listed in Table 6-52 and Table 6-53.

**Table 6-51: Planter Box Maintenance Quick Guide**

| <b>Inspection and Maintenance Activities Summary</b> |  |
|--|--|
| <b>Routine Maintenance</b>                           | <ul style="list-style-type: none"> <li>• Repair small eroded areas and ruts by filling with gravel. Overseed bare areas to reestablish vegetation</li> <li>• Remove trash and debris and rake surface soils to mitigate ponding</li> <li>• Remove accumulated fine sediments, dead leaves and trash to restore surface permeability</li> <li>• Remove any evidence of visual contamination from floatables such as oil and grease</li> <li>• Eradicate weeds and prune back excess plant growth that interferes with facility operation. Remove non-native vegetation and replace with native species</li> <li>• Remove sediment and debris accumulation near inlet and outlet structures to alleviate clogging</li> <li>• Clean and reset flow spreaders (if present) as needed to restore original function</li> <li>• Periodically observe function under wet weather conditions</li> </ul> |
| <b>Major Maintenance</b>                             | <ul style="list-style-type: none"> <li>• Repair structural damage to flow control structures including inlet, outlet, and overflow structures</li> <li>• Clean out under-drain, to alleviate ponding. Replace media (if ponding or loss of infiltrative capacity persists) and re-vegetate</li> <li>• Re-grade and re-vegetate to repair damage from severe erosion/scour channelization</li> <li>• Photographs taken before and after major maintenance is encouraged</li> </ul>  |

**Table 6-52: Routine Maintenance – Planter Boxes**

| <b>Defect or Problem</b>          | <b>Condition When Maintenance is Needed</b>  | <b>Results Expected When Maintenance Is Performed</b>   | <b>Frequency</b>   |
|-----------------------------------|--|---|--|
| Erosion                           | Splash pads or spreader incorrectly placed; eroded or scoured areas due to flow channelization, or higher flows. | No erosion on surface of basin. No erosion or scouring evident. For ruts or bare areas less than 12 inches wide, damaged areas repaired by filling with crushed gravel. | Annually prior to wet season.<br><br>After major storm events (>0.75 in/24 hrs) if spot checks of some planter boxes indicate widespread damage/ maintenance needs |
| Standing Water                    | When water stands in the basin between storms and does not drain freely (with 36- 48 hours after storm event).   | Water drains completely from basin as designed and surface is clear of trash and debris. Underdrains are cleared.   |  |
| Loss of surface permeability      | Accumulation of fine sediments, dead leaves, trash and other debris on surface                                   | Surface permeability restored. Surface layer removed and replaced with fresh mulch.   |  |
| Visual contaminants and pollution | Any visual evidence of oil, gasoline, contaminants or other pollutants.  | No visual contaminants or pollutants present.   | Monthly (or as dictated by agreement between County and landscape contractor)  |
| Vegetation                        | Weeds, excessive plant growth, plants interfering with basin operation, plants diseased or dying                 | Basin tidy, plants healthy and pruned. Any plants that interfere with function are removed. Invasive or non-acclimated plants replaced.                                 |  |
| Inlet/Overflow                    | Inlet/outlet areas clogged with sediment and/or debris.  | Material removed so that there is no clogging or blockage of the inlet or overflow area.  |  |
| Trash and debris                  | Any trash and debris which exceed 5 cubic feet per 1,000 square feet (one standard garbage can).                 | Trash and debris removed and facility looks well kept.  |  |



**Table 6-53: Major Maintenance – Planter boxes**

| <b>Defect or Problem</b> | <b>Condition When Maintenance is Needed</b>  | <b>Results Expected When Maintenance Is Performed</b>                                  | <b>Frequency</b>             |
|--------------------------|--|--|------------------------------|
| Standing water           | When water stands in the basin between storms and does not drain freely (with 36- 48 hours after storm event). | Planting media (sand, gravel, and topsoil) and vegetation removed and replaced.        | Annually prior to wet season |
| Erosion/<br>Scouring     | Bare spots greater than 12 inches  | No erosion on surface of basin. Large bare areas are re-graded and reseeded/replanted. | As needed                    |

### 6.9.3 Green Roof

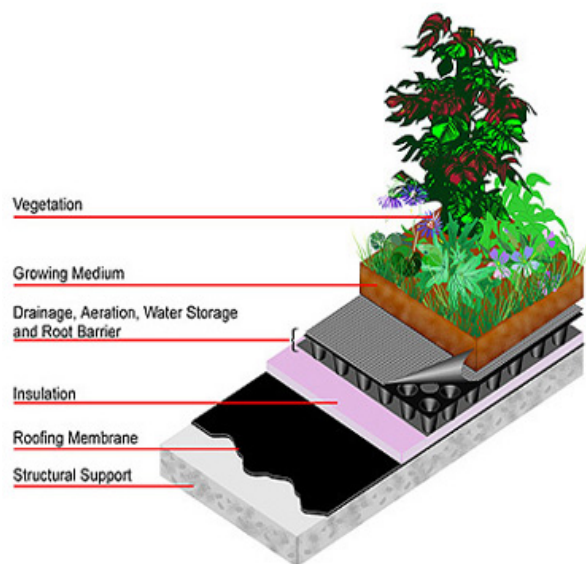

**Figure 6-20: Typical Cross Section of a Green Roof**

*Figure Credit: American Wick*

#### 6.9.3.1 Description

Green roofs are also known as ecoroofs and vegetated roof covers. Green roofs are roofing systems that layer a soil/vegetative cover over a waterproofing membrane. There are two types of green roofing systems; extensive, which is a light weight system and intensive, which is a heavier system that allows for larger plants but requires additional maintenance. A green roof mimics pre-development conditions by limiting the impervious area created by development. Green roofs filter, absorb, and evapotranspire precipitation to help mitigate the effects of urbanization on water quality and delivery of excess runoff to the local storm water conveyance systems.

#### 6.9.3.2 Applicability, Performance, and Limitations

A green roof's applicability is limited to rooftops or decks above building structures.

##### *Applicability and Performance*

Green roofs help control nitrogen as plants uptake nitrogen as they grow. In addition, pollutants adsorb to clay and organic matter in the soil layer, vegetation slows down the water, and the foliage collects dust. While study results are limited, it has been estimated that over 80% of TSS removal, 95% of cadmium, copper and lead, and 16% of zinc may be retained in green roof soils (London Ecology Unit, 1993; Georgia SWMM, 2001). The soil layer characteristics (i.e., composition and depth) greatly dictate the performance of the roof.

Green roofs (and other building BMPs) are generally intended for achieving moderate volume reduction and flow control. Green roofs do provide quantifiable reduction in volume; however,

##### Applications

- Residential
- Commercial and institutional
- Rooftops and decks above building structures

##### Advantages

- Combines stormwater treatment with runoff conveyance
- Volume & peak flow reduction
- Pollutant removal

##### Limitations

- Heavier than conventional roofs may require additional support
- Not applicable for completely flat roofs

they are not explicitly sized to meet the water quality treatment or volume reduction requirements. Rather, the volume reduction is accounted for implicitly in the calculations by assuming that the roof area is pervious rather than impervious when calculating a runoff coefficient for the site. Treatment effectiveness of green roofs (and other building BMPs) are not comparable to other BMPs that treat runoff from a wide range of impervious surfaces that generally have higher pollutant concentrations. Green roofs are not intended to be a primary BMP for meeting the peak runoff discharge requirement, although they do assist in reducing the peak runoff discharge rate by increasing the site’s pervious area and decreasing runoff volumes and velocities. See Section 6.2 for specific storm water runoff requirements for Tier 3 projects.

**Site Suitability Recommendations and Limitations**

Table 6-54 and associated guidance provide general considerations for assessing a site’s suitability for planter boxes.

**Table 6-54: Site Suitability Considerations for Green Roofs**

| BMP         | Tributary Area (Acres; Sq.Ft.) <sup>1</sup> | Site Slope (%) | Depth to Seasonally High Groundwater Table (ft) | Hydrologic Soil Group | Horizontal Setback from Drinking Water Wells (ft) |
|-------------|---|----------------|---|-----------------------|---|
| Green roofs | Equal to roof tributary area                | N/A            | N/A   | N/A                   | N/A   |

<sup>1</sup> Tributary area is the area of the site draining to the BMP. Tributary areas provided here shall be used as a general guideline only. Tributary areas can be larger or smaller in some instances.

Table 6-55 provides additional site applicability considerations for special design districts within the City including coastal bluff areas and hillside design districts.

**Table 6-55: Applicability of Planter Boxes for Special Design Districts**

| Coastal Bluff Area   | Hillside Design District   |
|--|--|
| Acceptable if overflow is captured in another acceptable BMP or if it is conveyed safely to a storm water conveyance system. | Acceptable if overflow is captured in another acceptable BMP or if it is conveyed safely to a storm water conveyance system. |

The following describes additional site suitability recommendations and limitations for green roofs.

- Shall not be located on steep roofs (>25%)
- Roof supports must be sufficient to support additional roof weight

**Multi-Use and Treatment Train Opportunities**

A green roof can be combined into a treatment train to provide enhanced water quality treatment and reductions in runoff volume and rate. For example, if a green roof is placed

upgradient of a cistern, the rate and volume of water flowing to the cistern can be reduced and the water quality enhanced. As another example, a bioretention unit could be placed downstream of a downspout that drains the green roof. In both cases, each facility can be reduced in size accordingly based upon demonstrated performance for meeting the storm water runoff requirements as outlined in Section 6.2 and addressing targeted pollutants of concern. In addition, green roofs can serve as aesthetic roof top garden areas and patios with outdoor seating.

**6.9.3.3 Design Criteria and Procedure**

Green Roofs shall be designed according to the current requirements of the City of Santa Barbara and the Santa Barbara County Flood Control and Water Conservation District. Standard design criteria for green roofs are listed in Table 6-56.

**Table 6-56: Green Roof Design Criteria**

| Design Parameter      | Unit           | Design Criteria  |
|-----------------------|----------------|--|
| Soil depth range      | inch           | 2 – 6 (depends on whether roof is designed to be extensive or intensive) |
| Saturated soil weight | lbs. / sq. ft. | 10 – 25  |
| Maximum roof slope    | %              | 25   |
| Minimum roof slope    | --             | Flat   |
| Vegetation type       | --             | Varies (see vegetation section below and Appendix G)                     |
| Vegetation height     | --             | Varies (see vegetation section below)                                    |

**Sizing**

Green roofs do provide quantifiable reduction in volume; however, they are not explicitly sized to meet the water quality treatment or volume reduction requirements. Rather, the volume reduction is accounted for implicitly in the calculations by assuming that the roof area is pervious rather than impervious when calculating a runoff coefficient for the site.

**Green Roof Components**

Structural Support

The first requirement that must be met before installing a green roof is the structural support of the roof. The roof must be able to support the additional weight of the soil, water, and vegetation. This is especially a concern for retrofit projects; so for retrofits, a licensed structural engineer shall be consulted to determine the current structural support present and what may need to be added to support the additional weight of 10 to 25 pounds per square foot. For new projects, the structural support concern shall be addressed during the design phase.

### Waterproof Roofing Membrane

Waterproof roofing membrane is an integral part of a green roofing system. The waterproof membrane prevents the roof runoff from penetrating and damaging the roofing material. There are many materials available for this purpose; they come in various forms (i.e., rolls, sheets, liquid) and exhibit different characteristics (e.g., flexibility, strength, etc.). Depending on the type of membrane chosen a root barrier may be required to prevent roots from compromising the integrity of the membrane.

### Drainage Layer

Depending on the design of the roof, a drainage layer may be required to move the excess runoff off of the roof. If a drainage layer is needed, there are numerous options including a gravel layer (that may require additional structural support), and many different styles and types of plastic.

### ***Soil Considerations***

Soils are an important factor in the construction and operation of green roofs. The soil layer must have excellent drainage, not be too heavy when saturated, and be adequately fertile as a growing medium for plants. Many companies sell their own proprietary soil mixes. However, a simple mix of ¼ topsoil, ¼ compost, and the remainder pumice perlite may be used for many applications. Other soil amendments may be substituted for the compost and the pumice perlite, see Section 5.10 for additional information on soil amendments. The soil mix used shall not contain any clay.

### ***Vegetation***

Green roofs must be vegetated in order to provide adequate treatment of runoff via filtration and evapotranspiration. Vegetation, when chosen and maintained appropriately, also improves the aesthetics of a site. Green roofs shall be about 90% vegetated with a mix of erosion-resistant plant species that effectively bind the soil and can withstand the extreme environment of rooftops. A diverse selection of low growing plants that thrive under the specific site, climatic, and watering conditions shall be specified. A mixture of drought tolerant, self-sustaining (perennial or self-sowing without need for fertilizers, herbicides, and or pesticides) is most effective. Plants selected shall also be low maintenance and able to withstand heat, cold, and high winds. Native or adapted sedum/succulent plants are preferred because they generally require less fertilizer, limited maintenance, and are more drought resistant than exotic plants. When appropriate, green roofs may be planted with larger plants; however, this is dependent of structural support and soil depth.

The following provides additional vegetation guidance for green roofs.

1. For extensive roofs, trees or shrubs may be used as long as the increased soil depth required may be supported.
2. Irrigation is required if the seed is planted in spring or summer. Use of a permanent irrigation system may help provide maximal water quality performance. Drought-tolerant plants shall be specified to minimize irrigation requirements.

3. Vegetation shall cover at least 90% of the total area
4. Locate the green roof in an area without excessive shade to avoid poor vegetative growth. For moderately shaded areas, shade tolerant plants shall be used.
5. See Appendix G for a recommended native plant list for green roofs, a list of local nurseries where these plants can be purchased, and a list of local and regional on-line resources. The plant list shall be used as a guide only and shall not replace project-specific planting recommendations provided by a landscape professional including recommendations on appropriate plants, fertilizer, mulching applications, and irrigation requirements (if any) to ensure healthy vegetation growth. See Section 5.11 for more information on landscaping/planting recommendations and Section 5.10 for more information on soil amendment recommendations.

***Drain***

1. There must be a drain pipe (gutter) to convey runoff safely from the roof to another basic or storm water runoff BMP, a pervious area, or the storm water conveyance system. See Section 5.3 Disconnecting Downspouts for more detail on directing roof drainage.

**6.9.3.4 Construction Recommendations**

1. Building structure must be adequate to hold the additional weight of the soil, retained water, and plants.
2. Plants shall be selected carefully to minimize maintenance and function properly.

### 6.9.3.5 Operations and Maintenance

#### *General Requirements*

1. During the establishment period, green roofs may need irrigation and occasional light fertilization until the plants have fully established themselves. Once healthy and fully established, plants shall no longer need irrigation except during extreme drought.
2. Weeding during the establishment period may be required to ensure proper establishment of the desired vegetation. Once established and assuming proper selection of vegetation, the vegetation shall not require any routine maintenance.
3. The roofing membrane must be inspected routinely, as it is a crucial element of the green roof. In addition, routine inspection of the drainage paths is required to ensure that there are no clogs in the system. If a green roof is not properly draining, the moisture in the system may cause the roof to leak and/or the plants to drown or rot. Leaks in the roof may occur not only due to improper drainage, but also if the correct combination of waterproofing barrier, root barrier, and drainage systems are not selected. Inspecting for a leak in the roofing system is advised, especially in locations prone to leaks, such as at all joints.
4. Inspect green roofs for erosion or damage to vegetation after every storm greater than 0.75" and at the end of the wet season to schedule summer maintenance and in the fall to ensure readiness for winter. Additional inspection after periods of heavy runoff is recommended. Green roofs shall be checked for debris, litter, and signs of clogging.
5. Replanting and/or reseeding of vegetation may be required for reestablishment.
6. Vegetation shall be healthy and dense enough to provide filtering while protecting underlying soils from erosion:
7. Fallen leaves and debris from deciduous plant foliage shall be removed.
8. Invasive vegetation, such as Alligatorweed (*Alternanthera philoxeroides*), Halogeton (*Halogeton glomeratus*), Spotted Knapweed (*Centaurea maculosa*), Giant Reed (*Arundo donax*), Castor Bean (*Ricinus communis*), Perennial Pepperweed (*Lepidium latifolium*), and Yellow Starthistle (*Centaurea solstitialis*) must be removed and replaced with non-invasive species. For more information on invasive weeds, including biology and control of listed weeds, look at the encyclopedias located at the California Department of Food and Agriculture website- [http://www.cdffa.ca.gov/phpps/ipc/encycloveedia/encycloveedia\\_hp.htm](http://www.cdffa.ca.gov/phpps/ipc/encycloveedia/encycloveedia_hp.htm) or the California Invasive Plant Council website at [www.cal-ipc.org](http://www.cal-ipc.org).
9. Dead vegetation shall be removed if greater than 10% of area coverage. Vegetation shall be replaced and established before the wet season to maintain cover density and control erosion where soils are exposed.

**Maintenance Standards**

A summary of the routine and major maintenance activities recommended for green roofs is shown in Table 6-57.

**Table 6-57: Green Roofs Maintenance Quick Guide**

| <b>Inspection and Maintenance Activities Summary</b> |  |
|--|--|
| <b>Routine Maintenance</b>                           | <ul style="list-style-type: none"> <li>• Trash and debris removal</li> <li>• Inspect roofing membrane for signs of damage</li> <li>• Inspect for leaks in roofing system</li> <li>• Inspect drainage paths for clogging, clean if necessary</li> <li>• Inspect for signs of erosion or damage to vegetation</li> <li>• Cleaning of drain (where applicable) and/or unclogging outlet to eliminate ponding water</li> <li>• Remove weeds and dead vegetation</li> <li>• Re-plant areas where weeds and dead vegetation were removed</li> <li>• Replace non-native vegetation with native species</li> <li>• Photographs taken before and after maintenance is encouraged</li> </ul> |
| <b>Major Maintenance</b>                             | <ul style="list-style-type: none"> <li>• Clean and or replace drainage layer</li> <li>• Re-vegetate bare exposed portions of the swale to restore vegetation to original level of coverage</li> <li>• Repair/Replace waterproof roofing membrane</li> </ul>  |



## 6.10 Retention and Detention BMPs

### 6.10.1 Constructed Treatment Wetland



**Figure 6-21: Constructed Treatment Wetland at University of California, Santa Barbara**

#### Applications

- Regional detention & treatment
- Roads, highways, parking lots, commercial, residential
- Parks, open spaces, and golf courses

#### Advantages

- Enhanced pollutant removal
- Aesthetically pleasing
- Creates wildlife habitat
- Treatment of large tributary areas

#### Limitations

- Requires year-round base flow
- Requires large footprint
- Concerns regarding vector infestation

#### 6.10.1.1 Description

A constructed treatment wetland is a system consisting of a sediment forebay and one or more permanent micro-pools with aquatic vegetation covering a significant portion of the basin. Constructed treatment wetlands typically include components such as an inlet with energy dissipation, a sediment forebay for settling out coarse solids and to facilitate maintenance, a base with shallow sections (1 to 2 feet deep) planted with emergent vegetation, deeper areas or micro pools (3 to 5 feet deep), and a water quality outlet structure. The interactions between the incoming storm water runoff, aquatic vegetation, wetland soils, and the associated physical, chemical, and biological unit processes are a fundamental part of constructed treatment wetlands. Therefore, it is critical that dry weather base flows exceed evaporation and infiltration losses to prevent loss of aquatic vegetation and to avoid stagnation and vector problems. In situations where dry weather flows are inadequate to support the treatment wetland size, an additional source of water may be needed during summer months. Otherwise, the wetland shall be sized based on the available base flow. In addition to water quality treatment, constructed wetlands can be designed for flow control by including extended detention above the permanent pool elevation.

Constructed treatment wetlands are generally designed as plug flow systems where the water already present in the permanent pool is displaced by incoming flows with minimal mixing and no short circuiting. Plug flow describes the hypothetical condition of storm water moving through the wetland in such a way that older “slugs” of water (meaning water that’s been in the wetland for longer) are displaced by incoming slugs of water with little or no mixing in the direction of flow. Short circuiting occurs when quiescent areas or “dead zones” develop in the

wetland where pockets of water remain stagnant, causing other volumes to bypass using shorter paths through the basin (e.g., incoming storm water slugs bypass these zones). Water quality benefits are also improved when the permanent wet pool volume is significantly greater than the water quality volume, resulting in longer residence times. If flow control using extended detention is desired for meeting peak discharge requirements, the wetland will first displace water present in the permanent pool with incoming flows (usually equal to or greater than the water quality treatment volume) and will then fill the wetland above the permanent pool elevation and allow the water level to drop back to the permanent pool elevation allowing higher flows to discharge from the wetland at rates required for meeting the peak runoff discharge requirements.

It is important to note the difference between constructed treatment wetlands and mitigation wetlands that are constructed as part of mitigation requirements. Constructed mitigation wetlands are intended to provide fully functional habitat similar to the habitat they replace. Constructed treatment wetlands are intended for water quality treatment and, when applicable, flow control. They shall be designed to capture and treat pollutants to protect receiving waters, including natural wetlands and other ecologically significant habitat. The accumulation of pollutants in sediment and vegetation of constructed treatment wetlands may impact the health of aquatic biota. As such, periodic sediment and vegetation removal within constructed treatment wetlands may be required. Constructed treatment wetlands can provide opportunities for wildlife enhancement, education, and aesthetics.

Factors that favor the selection of storm water wetlands over other kinds of BMPs include enhanced treatment capability (including dry-weather flow treatment), aesthetics, and the ability to mitigate large tributary areas. Factors that may limit the use of storm water wetland basins include overly permeable soils and/or non-existent base flows, public acceptance with regard to the potential for vector infestation, large footprint to tributary area ratios (up to 12% percent of tributary area, dependant on overall imperviousness of the tributary area) and high initial capital cost of implementation.

#### **6.10.1.2 Performance, Applicability, and Limitations**

Table 6-58, Table 6-59, and Table 6-60 provide a summary of BMP performance, applicability, and limitations for constructed treatment wetlands. *It is important to note that information in these tables shall be used to provide general guidance for constructed treatment wetlands and shall not replace the evaluation performed by a water quality professional.*

##### ***Applicability and Performance***

Table 6-58 and associated guidance provide general volume reduction capabilities and treatment effectiveness for constructed treatment wetlands. Refer to Section 6.4 for the process that shall be used for selecting BMPs based on pollutants of concern. Refer to Table 6-1 to determine the ranking of constructed treatment wetlands for removal of pollutants of concern as compared with other storm water runoff BMPs provided in Chapter 6. Refer to Table 6-2 to assess the applicability of constructed treatment wetlands for your site based on site suitability considerations as compared with other storm water runoff BMPs provided in Chapter 6. Constructed treatment wetlands are volume-based BMPs intended to provide water quality treatment and, when applicable, control of the peak runoff discharge rate using

extended detention above the wetland permanent pool (see Table 6-58). Although constructed treatment wetlands can produce significant volume reduction through evapotranspiration in the summer months, credit towards meeting the volume reduction requirement,  $V_{\text{reduction}}$ , is not given for constructed treatment wetlands because little volume reduction occurs during the winter months when storm water runoff is highest. See Section 6.2 for specific storm water runoff requirements for Tier 3 projects.

**Table 6-58: Volume Reduction & Treatment Effectiveness for Treatment Wetland**

| Storm Water Runoff BMP   | Volume Mitigation (% of inflow) | Treatment Effectiveness for Pollutants of Concern <sup>1</sup> |           |          |  |          |  |
|--|---------------------------------|--|-----------|----------|--|----------|--|
|  |                                 | Trash  | Nutrients | Bacteria | Metals (particulate and dissolved fractions) | Sediment | Organics (hydrocarbons, oil, and grease) |
| Constructed Treatment Wetland  |                                 |  |           |          |  |          |  |
| Volume/Treatment Effectiveness: ● = Very High, ◐ = High, ◑ = Moderate, ◒ = Low, ○ = Very Low |                                 |  |           |          |  |          |  |

<sup>1</sup> Effectiveness may change based on design variations; standard BMP designs have been assumed.

Constructed treatment wetlands have very high pollutant removal efficiencies and use multiple processes to treat storm water runoff including sedimentation, filtration, adsorption, plant uptake, and microbial/chemical biodegradation and precipitation. Sedimentation and filtration assist in the removal of total suspended solids (i.e., a surrogate for sediment), floating debris, trash, soil-bound phosphorus, and some soil-bound pathogens. Adsorption to soil particles assists in removal of dissolved metals and soluble phosphorus. Microbial processes (e.g., nitrification and denitrification) and chemical processes (e.g., precipitation) assist in removal of nitrogen, organics, pathogens, and metals. Plants can uptake small amounts of nutrients including nitrogen and phosphorus and, depending on plant type, can uptake varying amounts of metals. Some plant types can uptake large quantities of metals; this is called phytoremediation. Exposure to sunlight and dryness on the edges of the wetland and in areas that do not consistently stay wet assist in removal of pathogens (Hunt and Doll, 2000).

### ***Site Suitability Recommendations and Limitations***

Table 6-59 provides general considerations for assessing a site's suitability for constructed treatment wetlands.

**Table 6-59: Site Suitability Considerations for Treatment Wetlands**

| BMP                           | Tributary Area (Acres) <sup>1</sup> | Site Slope (%)   | Depth to Seasonally High Groundwater Table (ft) | Hydrologic Soil Group  | Horizontal Setback from Drinking Water Wells (ft) |
|-------------------------------|-------------------------------------|------------------|---|--|---|
| Constructed Treatment Wetland | > 5 Acres;<br>435,600 Sq.Ft.        | < 8 <sup>2</sup> | N/A   | "A" soils may require pond liner; "B" soils may require infiltration testing | N/A   |

<sup>1</sup> Tributary area is the area of the site draining to the BMP. Tributary areas provided here shall be used as a general guideline only. Tributary areas can be larger or smaller in some instances.

<sup>2</sup> If site slope exceeds that specified or if the system is within 200 ft from the top of a hazardous slope or landslide area (on the uphill side), a geotechnical investigation and report addressing slope stability shall be prepared by a licensed civil engineer.

Table 6-60 provides additional site suitability considerations for special design districts within the City, including coastal bluff areas and hillside design districts.

**Table 6-60: Applicability of Treatment Wetlands for Special Design Districts**

| Coastal Bluff Area                              | Hillside Design District   |
|---|--|
| Generally not acceptable in Coastal Bluff Areas | Acceptable if: (1) a geotechnical investigation proves that the facility does not compromise the stability of the site slope or surrounding slopes, or (2) the facility meets the site slope criteria in Table 6-59 and the facility is fully contained with an impermeable liner and overflow to a storm water conveyance system. |

The following provides additional site suitability guidelines and limitations:

- In theory, there are no limitations on the tributary area size draining to a constructed treatment wetland; however, constructed treatment wetlands usually require considerable land area. Typically, treatment wetlands capture runoff from tributary areas larger than 10 acres and less than 10 square miles. Smaller "pocket" wetlands can be feasible in areas where space is restricted.
- If the constructed treatment wetland is not used for flow control, the wetland must not interfere with flood control functions of existing conveyance and detention structures.
- Constructed treatment wetlands shall not be permitted in areas with site slopes greater than 7% or within 200 feet (on the uphill side) of a steep slope hazard area or a mapped landslide area unless a geotechnical investigation and report is completed by a licensed civil engineer.
- Constructed treatment wetlands require a regular source of water (base flow) to maintain wetland vegetation and associated treatment processes. If adequate base flow

is not available year-round, supplemental water may be needed during the summer months to maintain adequate base flow.

### ***Multi-Use and Treatment Train Opportunities***

Provided that the constructed treatment wetland has adequate storage, the wetland may be combined with a flow control basin to provide both water quality control and peak flow control. Wetlands can also be designed with wildlife viewing areas and walking trails around the perimeter to provide passive recreation. Flows may enter a constructed treatment wetland from a pretreatment BMP such as a vegetated swale filter or Vegetated filter strip. The vegetated swales and filter strips not only filter coarse sediments but also increase the site's time of concentration,  $T_c$ , thereby providing infiltration and evapotranspiration as well as reductions in site runoff discharge rates prior to entering the constructed treatment wetland.

#### **6.10.1.3 Design Criteria and Procedure**

The main challenge associated with constructed treatment wetlands is maintaining base flow to support vegetation. A constructed treatment wetland is illustrated schematically in Figure 6-22.

Constructed treatment wetlands shall be designed according to the current policies of the City and the County of Santa Barbara Flood Control District. Principal design criteria for constructed treatment wetlands are listed in Table 6-61.

**Table 6-61: Treatment Wetland Design Criteria**

| <b>Design Parameter</b>                                    | <b>Unit</b>     | <b>Design Criteria</b>                             |
|--|-----------------|--|
| Water quality design volume, $V_{wq}$                      | ft <sup>3</sup> | See Section 6.2.3 and Appendix C                   |
| Drawdown time for extended detention (over permanent pool) | hours           | 36-48  |
| Sediment forebay volume                                    | %               | 10-20 of total basin volume                        |
| Depth of sediment forebay                                  | feet            | 4-8 (1 foot of sediment storage required)          |
| Depth of wetland basin                                     | feet            | Varies see facility geometry section below         |
| Maximum residence time                                     | Days            | 7 (dry weather)                                    |
| Freeboard (minimum)  | inches          | 12 (off-line); 24 (on-line)                        |
| Flow path length to width ratio                            | L:W             | 3:1 (min.) 4:1 (preferred)                         |
| Side slope (maximum)                                       | H:V             | 4:1 Interior; 2:1 Exterior; 3:1 Landscaped         |
| Vegetation Type  | --              | Varies see vegetation section below and Appendix G |
| Vegetation Height  | --              | Varies see vegetation section below                |
| Buffer zone (minimum)                                      | feet            | 25   |
| Maintenance access ramp width                              | feet            | 16   |
| Minimum outflow device diameter                            | inches          | 18   |

***Sizing for Meeting the Storm Water Runoff Requirements***

Constructed treatment wetlands can be sized to meet all or part of the water quality design volume and peak runoff discharge rate requirements as outlined in Section 6.2 and Appendix C. A constructed treatment wetland sizing example is provided in Appendix D.

**Maintaining peak runoff discharge rate requirement**

The constructed treatment wetland can be designed with extended detention to provide sufficient storage for meeting all or part of the peak runoff discharge requirement for the 2-year through the 100-year, 24-hr design storm.

**Volume reduction requirement**

The volume reduction requirement cannot be met with constructed treatment wetlands.

**Water quality treatment volume requirement**

The constructed treatment wetland can be designed to treat all or part of the water quality treatment volume with a 36 to 48 hour drawdown time.

***Sizing for Meeting the Storm Water Runoff Requirements***

Wet retention basins can be sized to meet all or part of the water quality design volume and peak runoff discharge rate requirements as outlined in Section 6.2 and Appendix C. A wet retention basin sizing example is provided in Appendix D.

**Maintaining peak runoff discharge rate requirement**

The wet retention basin can be designed with extended detention (above the permanent pool) to provide sufficient storage for meeting all or part of the peak runoff discharge requirement for the 2-year through the 100-year, 24-hr design storm.

**Volume reduction requirement**

The volume reduction requirement cannot be met with constructed treatment wetlands.

**Water quality treatment volume requirement**

The constructed treatment wetland can be designed with or without extended detention (above the permanent pool) to treat all or part of the water quality treatment volume. If extended detention is provided, the drawdown time shall be between 36 to 48 hours.

***Geometry and Size***

In most cases, the constructed treatment wetland permanent pool shall be sized to be greater than or equal to the water quality design volume. If extended detention is provided above the permanent pool and the wetland is designed for water quality treatment only, then the permanent pool volume shall be a minimum of 80 percent of the water quality design volume and the surcharge volume (above the permanent pool) shall make up the remaining 20 percent and provide at least 12 hours of detention. If extended detention is provided and the basin is designed for water quality treatment and peak flow attenuation, then the permanent pool

volume shall be equal to the water quality treatment volume and the surcharge volume shall be sized to attenuate peak flows to meet the peak runoff discharge requirements. See Section 6.2 and Appendix C for water quality design volume and peak runoff discharge requirements and calculations. A constructed treatment wetland design example is provided in Appendix D. The extended detention portion of the wetland above the permanent pool, if provided, functions like a dry extended detention (ED) basin (see Section 6.10.3 for dry ED basin sizing guidelines).

1. Constructed treatment wetlands shall consist of at least two cells including a sediment forebay and a wetland basin.
2. The sediment forebay must contain between 10 and 20 percent of the total basin volume.
3. The depth of the sediment forebay shall be between 4 and 8 feet.
4. One foot of sediment storage shall be provided in the sediment forebay.
5. The "berm" separating the two basins shall be uniform in cross-section and shaped such that its downstream side gradually slopes to the main wetland basin.
6. The top of berm shall be either at the water quality design water surface or submerged 1 foot below the water quality design water surface, as with wet retention basins. Correspondingly, the side slopes of the berm must meet the following criteria:
  - a. If the type of the berm is at the water quality design water surface, the berm side slopes shall be no steeper than 4H:1V.
  - b. If the top of berm is submerged 1 foot, the upstream side slope may be a max of 3H:1V.
7. The constructed treatment wetlands shall be designed with a "naturalistic" shape and a range of depths intermixed throughout the wetland basin to a maximum of 5 feet.

| Depth Range (feet) | Percent by Area |
|--------------------|-----------------|
| 0.1 to 1           | 15              |
| 1 to 3             | 55              |
| 3 to 5             | 30              |

8. The flowpath length-to-width ratio shall be a minimum of 3:1, but preferably at least 4:1 or greater. *Intent: a high flow path length to width ratio will maximize fine sediment removal.*
9. The minimum freeboard shall be 1 foot above the maximum water surface elevation for on-line basins (2 feet preferable) and 1 foot above the maximum water surface elevation for on-line basins.
10. Wetland pools shall be designed such that the residence time for dry weather flows is no greater than 7 days. *Intent: Minimize vector and stagnation issues.*

### ***Water Supply***

Water balance calculations shall be provided to demonstrate that adequate water supply will be present to maintain a permanent pool of water during a drought year when precipitation is 50% of average for the site. Water balance calculations shall include evapotranspiration, infiltration, precipitation, spillway discharge, and dry weather flow (where appropriate).

Where water balance indicates that losses will exceed inputs, a source of water shall be provided to maintain the wetland water surface elevation throughout the year. The water supply shall be of sufficient quantity and quality to not have an adverse impact on the wetland water quality. Water that meets drinking water standards shall be assumed to be of sufficient quality.

### ***Soils Considerations***

1. Implementation of constructed treatment wetlands in areas with high permeability soils (>0.1 in/hr) requires liners to increase the chances of maintaining permanent pools and/or micro-pools in the basin. Liners can be either synthetic materials or imported lower permeability soils (i.e., clays). The water balance assessment shall determine whether a liner is required. The following conditions can be used as a guideline.
2. The wetland basin must retain water for at least 10 months of the year.
3. The sediment forebay must retain at least 3 feet of water year-round.
4. Many wetland plants can adapt to periods of summer drought, so a limited drought period is allowed in the wetland basin. This may allow for a soil liner rather than a geosynthetic liner. The sediment forebay must retain water year-round for presettling to be effective.
5. If low permeability soils are used for the liner, a minimum of 18 inches of native soil amended with good topsoil or compost (one part compost mixed with 3 parts native soil) must be placed over the liner (see soil amendment Section 5.10). If a synthetic material is used, a soil depth of 2 feet is recommended to prevent damage to the liner during planting.

### ***Buffer Zone***

A minimum of 25 feet buffer shall be provided around the top perimeter of the constructed treatment wetlands.

### ***Energy Dissipation***

1. The inlet to the constructed treatment wetland shall be submerged with the inlet pipe invert a minimum of two feet from the cell bottom (not including sediment storage). The top of the inlet pipe shall be submerged at least 1 foot, if possible. *Intent: the inlet is submerged to dissipate energy of the incoming flow. The distance from the bottom is set to minimize resuspension of settled sediments. Alternative inlet designs that accomplish these objectives are acceptable.*



2. Energy dissipation controls must also be used at the outlet/spillway from the constructed treatment wetlands unless the wetland discharges to a storm water conveyance system or hardened channel.

### ***Vegetation***

1. The wetland cell(s) shall be planted with emergent wetland plants following the recommendations of a wetlands specialist.
2. Landscaping outside of the basin is required for all constructed wetlands and must adhere to the following criteria so as not to hinder maintenance operations:
  - a. No trees or shrubs may be planted within 15 feet of inlet or outlet pipes or manmade drainage structures such as spillways, flow spreaders, or earthen embankments. Species with roots that seek water, such as willow or poplar, shall not be used within 50 feet of pipes or manmade structures. Weeping willow (*Salix babylonica*) shall not be planted in or near detention basins.
  - b. Prohibited non-native plant species will not be permitted. For more information on invasive weeds, including biology and control of listed weeds, look at the encyclopededia located at the California Department of Food and Agriculture website- [http://www.cdfa.ca.gov/phpps/ipc/encycloweedia/encycloweedia\\_hp.htm](http://www.cdfa.ca.gov/phpps/ipc/encycloweedia/encycloweedia_hp.htm) or the California Invasive Plant Council website at [www.cal-ipc.org](http://www.cal-ipc.org).
3. See Appendix G for a recommended native plant list for constructed treatment wetlands, a list of local nurseries where these plants can be purchased, and a list of local and regional on-line resources. The plant list shall be used as a guide only and shall not replace project-specific planting recommendations provided by a wetland ecologist or a qualified landscape professional including recommendations on appropriate plants, fertilizer, mulching applications, and irrigation requirements (if any) to ensure healthy vegetation growth. See Section 5.11 for more information on landscaping/planting recommendations and Section 5.10 for more information on soil amendment recommendations.

### ***Outlet Structure***

An outlet pipe and outlet structure shall be provided. The outlet pipe may be a perforated standpipe strapped to a manhole (see Figure 6-25) or placed in an embankment, suitable for extended detention, or may be back-sloped to a catch basin with a grated opening (jail house window) or manhole with a cone grate (birdcage) (see Figure 6-26). The grate or birdcage openings provide an overflow route should the basin outlet pipe become clogged.

For wetlands with detention, the outlet structures shall be designed to provide 12 hours emptying time for the water quality volume or the required detention necessary for achieving the peak runoff discharge requirements if the extended detention is designed for flow attenuation.

The wetland outlet pipe shall be sized, at a minimum, to pass flows greater than the water quality design peak flow for on-line basins or flows greater than the peak runoff discharge rate for the 100-year, 24-hr design storm for on-line basins.

See the dry extended detention section (Section 6.10.3) and Appendix E for further detail on outlet sizing.

### ***Emergency Spillway***

An emergency overflow spillway in addition to the primary overflow outlet (as described above) is required. The emergency spillway shall be sized for flows greater than the peak 100-year 24-hour storm if the basin is designed on-line or, if the basin is designed on-line, the spillway shall be sized for flows greater than the basin design volume (e.g., water quality design volume). The spillway shall be constructed with reinforced concrete and provide for adequate energy dissipation downstream. The spillway shall allow for at least 12 inches of freeboard above the emergency overflow water surface elevation if the basin is on-line. If the basin is on-line, 2 feet of freeboard is preferable.

Spillways shall meet the California Department of Water Resources, Division of Safety of Dams Guidelines for the Design and Construction of Small Embankment Dams (<http://damsafety.water.ca.gov/docs/GuidelinesSmallDams.pdf>). *Intent: Emergency overflow spillways are intended to control the location of basin overtopping and safely direct overflows back into the downstream conveyance system or other acceptable discharge point.*

### On-line Basins

1. On-line basins must have an emergency overflow spillway to prevent overtopping of walls or berms should blockage of the primary outlet occur based on a downstream risk assessment.
2. The overflow spillway must be sized to pass flows greater than the design peak runoff discharge rate for the 100-yr, 24-hr storm.
3. The minimum freeboard shall be 1 foot (but preferably at least 2 feet) above the maximum water surface elevation over the emergency spillway.

### Off-line Basins

1. Off-line basins must have either an emergency overflow spillway or an emergency overflow riser. The emergency overflow must be designed to pass the 100-yr 24-hr post-development peak storm water runoff discharge rate (see Appendix E for further detail) directly to the downstream conveyance system or another acceptable discharge point. Where an emergency overflow spillway would discharge to a steep slope, an emergency overflow riser, *in addition* to the spillway shall be provided.
2. The emergency overflow spillway shall be armored to withstand the energy of the spillway flows (Figure 6-32). The spillway shall be constructed of grouted rip-rap.
3. The minimum freeboard shall be 1 foot above the maximum water surface elevation over the emergency spillway.

### ***Side Slopes***

1. Interior side slopes above the water quality design depth and up to the emergency overflow water surface shall be no steeper than 4:1 (H:V), unless stabilization has been approved by a licensed civil engineer and the City.

2. Exterior side slopes shall be no steeper than 2:1 (H:V), unless stabilization has been approved by a licensed civil engineer and the City.
3. For any slope (interior or exterior) steeper than 2:1 (H:V), a geotechnical investigation and report must be submitted and approved by the City.
4. Landscaped slopes must be no steeper than 3:1 (H:V) to allow for maintenance.
5. Basin walls may be vertical retaining walls, provided: (a) they are constructed of reinforced concrete, (b) a fence is provided along the top of the wall (see fencing below) or further back, and (c) the design is stamped by a licensed civil engineer and approved by the City.

### ***Embankments***

1. Earthworks and berm embankments shall be performed in accordance with the latest edition of the "Greenbook Standard Specifications for Public Works Construction".
2. Embankments are earthen slopes or berms used for detaining or redirecting the flow of water.
3. Top of berm shall be 2 feet minimum below the water quality design water surface and shall be keyed into embankment a minimum of 1 foot on both sides.
4. Typically, the top width of berm embankments is at least 20 feet, but narrower embankments may be plausible if approved by the civil engineer and the City.
5. Basin berm embankments must be constructed on native consolidated soil (or adequately compacted and stable fill soils analyzed by a licensed civil engineer) free of loose surface soil materials, roots, and other organic debris.
6. Basin berm embankments greater than 4 feet in height must be constructed by excavating a key equal to 50% of the berm embankment cross-sectional height and width. This requirement may be waived if specifically recommended by a licensed civil engineer.
7. The berm embankment shall be constructed of compacted soil (95% minimum dry density, modified proctor method per ASTM D1557), placed in 6-inch lifts.
8. Low growing native or non-invasive perennial grasses shall be planted on downstream embankment slopes. See vegetation section below.

### ***Fencing***

Safety is provided either by fencing of the facility or by managing the contours of the basin to eliminate drop-offs and other hazards.

1. In accordance with the Santa Barbara Flood Control District *Standard Conditions of Project Plan Approval*, facilities to be dedicated to the City, perimeter fencing (minimum height of 42 inches) shall be required on all basins exceeding two feet in depth or where interior side slopes are steeper than 6:1 (H:V).

2. If fences are required, fences shall be designed and constructed in accordance with current policies of the Santa Barbara County Flood Control District and must be located at or above the overflow water surface elevation. Shrubs (approved, California-adapted species) can be used to hide the fencing. See vegetation section above.

### ***Right-of-Way***

1. Constructed treatment wetlands and associated access roads to be maintained by the City shall be dedicated in fee or in an easement to the City with appropriate access.

### ***Maintenance Access***

1. Ownership of the basin and maintenance thereof is the responsibility of the developer/applicant. A maintenance agreement with the City is required to ensure adequate performance and allow the City emergency access to the facilities.
2. Maintenance access road(s) shall be provided to the control structure and other drainage structures associated with the basin (e.g., inlet, emergency overflow or bypass structures). Manhole and catch basin lids must be in or at the edge of the access road.
3. A graded 16-foot wide access ramp into the basin shall be constructed near the basin outlet. An access ramp is required for removal of sediment with a backhoe or loader and truck. The ramp must extend to the basin bottom to avoid damage to vegetation planted on the basin slope. A 16-foot wide commercial driveway approach shall be provided where curb and gutter front the maintenance ramp.
4. All access ramps and roads shall be provided in accordance with the current policies of the Flood Control District.

### ***Vector Control***

1. A Mosquito Management Plan or Service Contract must be approved or waived by the Santa Barbara Coastal Vector Control District for any facility that maintains a pool of water for 72 hours or more.

#### **6.10.1.4 Construction Considerations**

The use of treated wood or galvanized metal anywhere inside the facility is prohibited. The use of galvanized fencing is permitted if in accordance with the Fencing requirement above.

Figure 6-22: Constructed Treatment Wetland Schematic

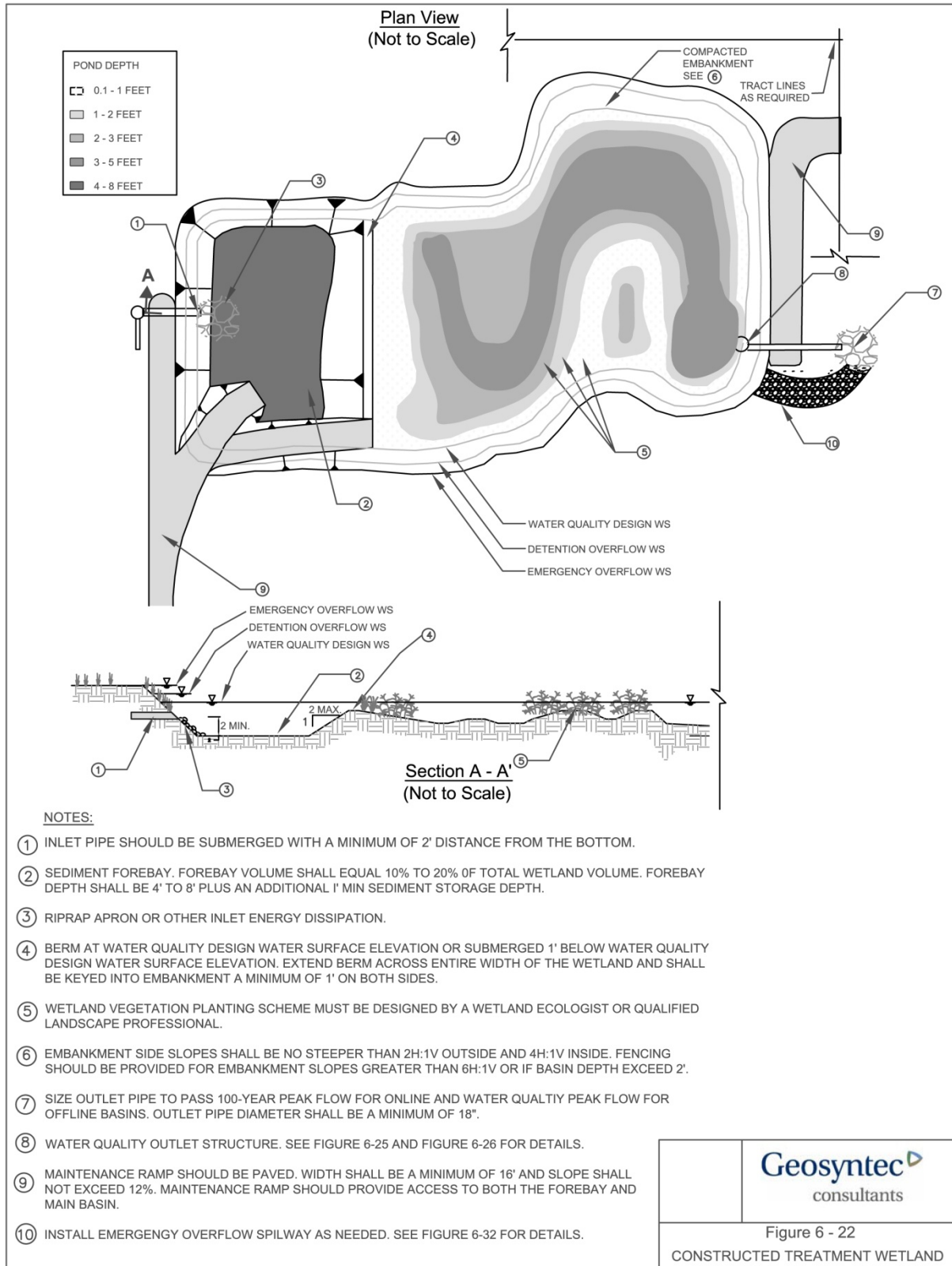

### 6.10.1.5 Operations and Maintenance

#### *General Requirements*

Maintenance is of primary importance if constructed treatment wetlands basins are to continue to function as originally designed. A specific maintenance plan shall be formulated for each facility outlining the schedule and scope of maintenance operations, as well as the data handling and reporting requirements. The following are general maintenance requirements:

1. The constructed treatment wetlands basin shall be inspected annually and inspections after major storm events are encouraged (see Appendix H for a constructed treatment wetland inspection and maintenance checklist). Trash and debris shall be removed as needed, but at least annually prior to the beginning of the wet season.
2. Site vegetation shall be maintained as frequently as necessary to maintain the aesthetic appearance of the site and to prevent clogging of outlets, creation of dead volumes, and barriers to mosquito fish to access pooled areas, and as follows:
3. Vegetation, large shrubs, or trees that limit access or interfere with basin operation shall be pruned or removed.
4. Slope areas that have become bare shall be revegetated and eroded areas shall be regraded prior to being revegetated.
5. Invasive vegetation, such as Alligatorweed (*Alternanthera philoxeroides*), Halogeton (*Halogeton glomeratus*), Spotted Knapweed (*Centaurea maculosa*), Giant Reed (*Arundo donax*), Castor Bean (*Ricinus communis*), Perennial Pepperweed (*Lepidium latifolium*), and Yellow Starthistle (*Centaurea solstitialis*) must be removed and replaced with non-invasive species. Invasive species shall never contribute more than 25% of the vegetated area. For more information on invasive weeds, including biology and control of listed weeds, look at the encycloweedia located at the California Department of Food and Agriculture website- [http://www.cdfa.ca.gov/phpps/ipc/encycloweedia/encycloweedia\\_hp.htm](http://www.cdfa.ca.gov/phpps/ipc/encycloweedia/encycloweedia_hp.htm) or the California Invasive Plant Council website at [www.cal-ipc.org](http://www.cal-ipc.org).
6. Dead vegetation shall be removed if it exceeds 10% of area coverage. This does not include seasonal die-back where roots would grow back later in colder areas. Vegetation shall be replaced immediately to maintain cover density and control erosion where soils are exposed.
7. Sediment buildup exceeding 6 inches over the storage capacity in the first cell shall be removed. Sediments shall be tested for toxic substance accumulation in compliance with current disposal requirements if land uses in the catchment include commercial or industrial zones, or if visual or olfactory indications of pollution are noticed. If toxic substances are encountered at concentrations exceeding thresholds of Title 22, Section 66261 of the California Code of Regulations, the sediment must be disposed of in a hazardous waste landfill.

8. Following sediment removal activities, replanting, and/or reseeding of vegetation may be required for reestablishment.

### ***Maintenance Standards***

A summary of the routine and major maintenance activities recommended for wetland basins is shown in Table 6-62. Detailed routine and major maintenance standards listed in Table 6-63 and Table 6-64 are intended to be measures to determine if maintenance actions are required as identified through inspection. They are not intended to be measures of the facility's required condition at all times between inspections. In other words, exceedance of these thresholds or measures at any time between inspections and/or scheduled maintenance does not constitute a violation of these standards. These standards are violated only when an inspection identifies required maintenance action that has not been scheduled before the next regular inspection.

**Table 6-62: Treatment Wetland Maintenance Quick Guide**

| <b>Inspection and Maintenance Activities Summary</b> |  |
|--|--|
| <b>Routine Maintenance</b>                           | <ul style="list-style-type: none"> <li>• Trash and debris removal</li> <li>• Remove minor sediment accumulation near inlet and outlet structures</li> <li>• Stabilize/repair eroded banks and fill in animal burrows if present</li> <li>• Remove any evidence of visual contamination from floatables such as oil and grease</li> <li>• Eliminate pests and conditions suitable for creating ideal breeding habitat</li> <li>• Install or repair pond liner to ensure that first cell maintains a permanent pool</li> <li>• Remove algae mats as often as needed to prevent coverage of more than 20% of wetland surface</li> <li>• Mow berms routinely if applicable to maintain aesthetic appeal and to suppress weeds</li> </ul>   |
| <b>Major Maintenance</b>                             | <ul style="list-style-type: none"> <li>• Remove dead, diseased, or dying trees and woody vegetation that interfere with facility maintenance.</li> <li>• Correct problems associated with berm settlement</li> <li>• Repair berm/dike breaches and stabilize eroded parts of the berm</li> <li>• Repair and rebuild spillway as needed to reverse the effects of severe erosion</li> <li>• Remove sediment build up in forebay and main wetland area to restore original sediment holding capacity</li> <li>• Re-grade main wetland bottom to restore bottom slope and eliminate the incidence of standing pools</li> <li>• Aerate compacted areas to promote infiltration if volume reductions are desired</li> <li>• Repair or replace gates, fences, flow control structures, and inlet/outlet structures as needed to maintain full functionality</li> </ul> |

Table 6-63: Routine Maintenance Standards – Treatment Wetlands

| Defect                | Conditions When Maintenance Is Needed  | Results Expected When Maintenance Is Performed   | Frequency  |
|-----------------------|--|--|--|
| Trash & Debris        | Any trash and debris which exceed 5 cubic feet per 1,000 sf of wetland area (one standard garbage can). In general, there shall be no visual evidence of dumping.<br>If less than threshold all trash and debris will be removed as part of next scheduled maintenance. If trash and debris is observed blocking or partially blocking an outlet structure or inhibiting flows between cells, it shall be removed quickly. | Trash and debris cleared from site.  | Annually prior to wet season<br><br>After major storm events (>0.75 in/24 hrs) if spot checks of some basins indicate widespread damage/ maintenance needs |
| Sediment Accumulation | Sediment accumulation in wetland bottom that exceeds the depth of sediment zone plus 6 inches in the sediment forebay. If sediment is blocking an inlet or outlet, it shall be removed.  | Sediment cleaned out.  |  |
| Erosion               | Erosion of wetland's side slopes and/or scouring of wetland bottom.  | Slopes shall be stabilized using appropriate erosion control measure(s) and repair methods.  |  |
| Oil Sheen on Water    | Prevalent and visible oil sheen.   | No oil sheen present.  |  |
| Noxious Pests         | Visual observations or receipt of complaints of numbers of pests that would not be naturally occurring and could pose a threat to human or aquatic health.   | Vectors controlled per Santa Barbara Coastal Vector Control District. A Mosquito Management Plan or Service Contract must be presented to the Vector Management District for any facility that maintains a pool of water for 72 hours or more. |  |
| Water Level           | First cell empty, doesn't hold water.  | Line the first cell to maintain at least 4 feet of water. The first cell must remain full to control turbulence of the incoming flow and reduce sediment resuspension.   |  |



| Defect        | Conditions When Maintenance Is Needed                                | Results Expected When Maintenance Is Performed  | Frequency   |
|---------------|--|---|---|
| Aesthetics    | Minor vegetation removal and thinning. Mowing berms and surroundings | Facility is well kept.  | Monthly (or as dictated by agreement between County and landscape contractor) |
| Noxious Weeds | Any evidence of noxious weeds.                                       | Eradicate all noxious weeds; control and prevent the spread of all noxious weeds. Use Integrated Pest Management techniques, if applicable. See <a href="http://www.ipm.ucdavis.edu">http://www.ipm.ucdavis.edu</a> for more information. |   |

**Table 6-64: Major Maintenance Standards – Treatment Wetlands**

| Defect              | Conditions When Maintenance Is Needed  | Results Expected When Maintenance Is Performed   | Frequency   |
|---------------------|--|--|---|
| Tree Growth         | Tree growth does not allow maintenance access or interferes with maintenance activity (i.e., slope mowing, silt removal, vactoring, or equipment movements). If trees are not interfering, do not remove. Dead, diseased, or dying trees shall be removed. | Trees do not hinder maintenance activities. Remove dead, diseased, or dying trees. (Use a certified Arborist to determine health of tree or removal requirements). | Annual or as needed (infrequent)<br>After major storm events (>0.75 in/24 hrs) if spot checks of some basins indicate widespread damage/ maintenance needs. |
| Settling of Berm    | If settlement is apparent. Settling can be an indication of more severe problems with the berm or outlet works. A civil engineer shall be consulted to determine the source of the settlement if the dike/berm is serving as a dam.                        | Dike is built back to the design elevation.  |   |
| Piping through Berm | Discernable water flow through basin berm. Ongoing erosion with potential for erosion to continue. A licensed civil engineer shall be called in to inspect and evaluate condition and recommend repair of condition.                                       | Piping eliminated. Erosion potential resolved and berm stability achieved.   |   |

| Defect   | Conditions When Maintenance Is Needed   | Results Expected When Maintenance Is Performed  | Frequency |
|--|---|---|-----------|
| Tree and Large Shrub Growth on Downstream Slope of Embankments | Tree and large shrub growth on downstream slopes of embankments may prevent inspection and provide habitat for burrowing rodents. | Trees and large shrubs shall be removed. All dead roots shall be removed if practical. Otherwise, dead roots shall be removed to a minimum of 36 inches below grade and replaced with cement grout to 12 inches below grade. The top 12 inches of the root holes shall be filled with compacted, in-situ soils. The area facility engineer may require additional root removal if necessary for dam safety or maintenance purposes. |           |
| Erosion on Spillway  | Rock is missing and soil is exposed at top of spillway or outside slope.  | Rocks and pad depth are restored to design standards.   |           |
| Gate/Fence Damage  | Damage to gate/fence, including missing locks and hinges  | Gate/Fence repaired.  |           |

### 6.10.2 Wet Retention Basins



**Figure 6-23: Wet Retention Basin with Vegetation Along Perimeter**

#### Applications

- Regional detention & treatment
- Roads, highways, parking lots, commercial, residential
- Parks, open spaces, and golf courses

#### Advantages

- Efficient removal of pollutants adsorbed to sediments
- Can provide treatment for large tributary areas

#### Limitations

- Require regular base flows if water level is to be maintained
- Large footprint area required
- Not permitted near steep slopes

#### 6.10.2.1 Description

Wet retention basins are constructed, naturalistic ponds with a permanent or seasonal pool of water (also called a “wet pool” or “dead storage”). Aquascape facilities, such as artificial lakes, are a special form of wet pool facility that can incorporate innovative design elements to allow them to function as a storm water treatment facility in addition to an aesthetic water feature. Wetponds require base flows to exceed or match losses through evaporation and/or infiltration and they must be designed with the outlet positioned and/or operated in such a way as to maintain a permanent pool. Wetponds can be designed to provide extended detention of incoming flows using the volume above the permanent pool surface.

The applications for wet retention basins are similar to those of dry extended detention (ED) basins and include peak flow attenuation (with ED), varying amounts of volume reduction, and pollutant removal. The main pollutant removal mechanism in wet retention basins is sedimentation; other pollutant reduction processes occurring in wet retention basins include dilution, adsorption, biological and chemical processes such as microbially-mediated biodegradation and precipitation, plant uptake, and storage. The permanent pool of water in the wet retention basins improves treatment of fine particulates and associated pollutants and provides treatment of dry weather flows (nuisance flows). Permanent pools also allow wet retention basins to be designed as aesthetically pleasing water features with additional recreational, wildlife habitat, and educational benefits. Compared to an ED basin of equal volume, a well-designed wet retention basin provides improved water quality treatment by increasing the average hydraulic residence time of storm water in the facility.

Wet retention basins work best under plug flow conditions where the water already present in the permanent pool is displaced by incoming flows with minimal mixing and no short circuiting.

Plug flow describes the hypothetical condition of storm water moving through the basin in such a way that older “slugs” of water (meaning water that’s been in the basin for longer) are displaced by incoming slugs of water with little or no mixing in the direction of flow. Short circuiting occurs when quiescent areas or “dead zones” develop in the basin where pockets of water remain stagnant, causing other volumes to bypass using shorter paths through the basin (e.g., incoming storm water slugs bypass these zones). Water quality benefits are also improved when the permanent wet pool volume is significantly greater than the water quality volume, resulting in longer residence times.

Of specific concern in Southern California is the drying of permanent pools due to lack of sufficient base flow to balance evaporation and infiltration. While water quality and aesthetics are sacrificed through loss of the permanent pool, it is acceptable for wet retention basins to dry out for part of the year. Even without a permanent pool, wet retention basins will still provide water quality benefits through capture and infiltration of nuisance flows. However, lakes shall be designed to maintain a permanent pool of water year-round to support the riparian and aquatic vegetation. Consequently, lakes are only appropriate where base flows are sufficient to maintain the permanent pool, or an additional source of water supply (e.g., potable, reclaimed, etc.) is available to supplement base flows during critical periods.







#### **6.10.2.2 Performance, Applicability, and Limitations**

Table 6-65, Table 6-66, and Table 6-67 provide a summary of BMP performance, applicability, and limitations for wet retention basins. *It is important to note that information in these tables shall be used to provide general guidance for wet retention basins and shall not replace the evaluation performed by a water quality professional.*

##### ***Applicability and Performance***

Table 6-65 and associated guidance provide general volume reduction capabilities and treatment effectiveness for wet retention basins. Refer to Section 6.4 for the process that shall be used for selecting BMPs based on pollutants of concern. Refer to Table 6-1 to determine the ranking of constructed treatment wetlands for removal of pollutants of concern as compared with other storm water runoff BMPs provided in Chapter 6. Refer to Table 6-2 to assess the applicability of constructed treatment wetlands for your site based on site suitability considerations as compared with other storm water runoff BMPs provided in Chapter 6. Wet retention basins are volume-based BMPs intended to provide water quality treatment and, when extended detention is provided, attenuate peak runoff discharge rates (see Table 6-65). Although wet retention basins can produce significant volume reduction though evapotranspiration in the summer months (although not as much as constructed treatment wetlands), credit towards meeting the volume reduction requirement,  $V_{\text{reduction}}$ , is not given for wet retention basins because little volume reduction occurs during the winter months when storm water runoff is highest. See Section 6.2 for specific storm water runoff requirements for Tier 3 projects.

**Table 6-65: Volume Reduction & Treatment Effectiveness for Wet Retention Basins**

| Storm Water Runoff BMP   | Volume Mitigation (% of inflow)   | Treatment Effectiveness for Pollutants of Concern <sup>1</sup>                    |   |   |   |   |   |
|--|---|---|---|---|---|---|---|
|  |   | Trash   | Nutrients   | Bacteria  | Metals (particulate and dissolved fractions)  | Sediment  | Organics (hydrocarbons, oil, and grease)  |
| Wet Retention Basin  |  |  |  |  |  |  |  |
| Volume/Treatment Effectiveness: ● = Very High, ◐ = High, ● = Moderate, ◑ = Low, ○ = Very Low |   |   |   |   |   |   |   |

<sup>1</sup> Effectiveness may change based on design variations; standard BMP designs have been assumed.

Research has shown that wet retention basins have a very high removal rate for sediment, often 70 percent and higher for total suspended solids (TSS), provided the basin is well-maintained. This is because the runoff slows down as it enters the basin and the sediment, as well as sediment bound pollutants such as phosphorus, metals, and pesticides, are removed through sedimentation. Wet retention basins are not as efficient at removal of nitrate-nitrogen as constructed treatment wetlands due to less opportunity for anaerobic denitrification to occur.

### *Site Suitability Recommendations and Limitations*

Table 6-66 provides general guidance for assessing a site's suitability for wet retention basins.

**Table 6-66: Site Suitability Considerations for Wet Retention Basins**

| BMP                  | Tributary Area (Acres) <sup>1</sup> | Site Slope (%)    | Depth to Seasonally High Groundwater Table (ft) | Hydrologic Soil Group   | Horizontal Setback from Drinking Water Wells (ft) |
|----------------------|-------------------------------------|-------------------|---|---|---|
| Wet Retention Basins | > 10 Acres;<br>435,600 Sq.Ft.       | < 15 <sup>2</sup> | N/A   | "A" soils may require pond liner;<br>"B" soils may require infiltration testing | N/A   |

<sup>1</sup> Tributary area is the area of the site draining to the BMP. Tributary areas provided here shall be used as a general guideline only. Tributary areas can be larger or smaller in some instances.

<sup>2</sup> If site slope exceeds that specified or if the system is within 200 ft from the top of a hazardous slope or landslide area (on the uphill side), a geotechnical investigation and report addressing slope stability shall be prepared by a licensed civil engineer. In addition, for swales, if the longitudinal slope exceeds 6%, check dams shall be provided.

Table 6-67 provides additional site suitability considerations for special design districts within the City including coastal bluff areas and hillside design districts.

**Table 6-67: Applicability of Wet Retention Basins for Special Design Districts**

| Coastal Bluff Area                               | Hillside Design District   |
|--|--|
| Generally not acceptable in Coastal Bluff Areas. | Acceptable if: (1) a geotechnical investigation proves that the facility does not compromise the stability of the site slope or surrounding slopes, or (2) the facility meets the site slope criteria in Table 6-66 and the facility is fully contained with an impermeable liner and overflow to a storm water conveyance system. |

The following provides additional site suitability recommendations and limitations related to wet retention basins.

- Wet retention basins typically are used for treating areas larger than 10 acres and less than 10 square miles. They are especially applicable for regional water quality treatment and flow control.
- Off-line wet retention basins must not interfere with flood control functions of existing conveyance and detention structures.
- If wet retention basins are located in areas with site slopes greater than 15% or within 200 feet of a hazardous steep slope or mapped landslide area (on the uphill side), a geotechnical investigation and report must be provided to ensure that the basin does not compromise the stability of the site slope or surrounding slopes.
- Wet retention basins require a regular source of base flow if water levels are to be maintained. If base flow is insufficient during summer months, supplemental water may be necessary to maintain water levels.

### ***Multi-Use and Treatment Train Opportunities***

Provided adequate surcharge storage, a wet retention basin may be combined with a flood control basin to provide both water quality control and peak flow control. This type of basin is termed an extended detention (ED) wet retention basin. Wet retention basins can also be designed with wildlife viewing areas and walking trails around the perimeter to provide passive recreation. Flows may enter a wet retention basin from a pretreatment BMP such as a vegetated swale filter or Vegetated filter strip. The vegetated swales and filter strips not only filter course sediments but also increase the site's time of concentration,  $T_c$ , thereby providing some infiltration and evapotranspiration as well as reducing the site's runoff discharge rates.

**6.10.2.3 Design Criteria and Procedure**

The main challenge associated with wet retention basins is maintaining desired water levels. A wet retention basin is illustrated schematically in Figure 6-24.

Wet retention basins shall be designed according to the current policies of the City and the County of Santa Barbara Flood Control District. Principal design criteria for a wet retention basin are listed in Table 6-68.

**Table 6-68: Wet Retention Basin Design Criteria**

| Design Parameter   | Unit            | Design Criteria  |
|--|-----------------|--|
| Maintaining peak runoff discharge rate requirement         | cfs             | See Section 6.2.1 and Appendix C, must be used with a extended detention |
| Water quality design volume, $V_{wq}$                      | ft <sup>3</sup> | See Section 6.2.3 and Appendix C   |
| Drawdown time for extended detention (over permanent pool) | hours           | 48   |
| Depth without sediment storage                             | feet            | 4 (first cell minimum)<br>8 (any cell maximum)                           |
| Maximum residence time                                     | Days            | 7 (dry weather)  |
| Freeboard (minimum)  | inches          | 12 (off-line); 24 (on-line)  |
| Flow path length to width ratio                            | L:W             | 1.5:1 (min.) 2:1 (preferred)   |
| Side slope (maximum)                                       | H:V             | 4:1 (H:V) Interior and 2:1 (H:V) Exterior                                |
| Longitudinal slope   | percentage      | 1 (forebay) and 0-2 (main basin)   |
| Vegetation Type  | --              | Varies see vegetation section below and Appendix G                       |
| Vegetation Height  | --              | Varies see vegetation section below                                      |
| Buffer zone (minimum)                                      | feet            | 25   |
| Maintenance access ramp width                              | feet            | 16   |
| Minimum outflow device diameter                            | inches          | 18   |

***Sizing for Meeting the Storm Water Runoff Requirements***

Wet retention basins can be sized to meet all or part of the water quality design volume and peak runoff discharge rate requirements as outlined in Section 6.2 and Appendix C. A wet retention basin sizing example is provided in Appendix D.

**Maintaining peak runoff discharge rate requirement**

The wet retention basin can be designed with extended detention (above the permanent pool) to provide sufficient storage for meeting all or part of the peak runoff discharge requirement for the 2-year through the 100-year, 24-hr design storm.

Volume reduction requirement

The volume reduction requirement cannot be met with constructed treatment wetlands.

Water quality treatment volume requirement

The constructed treatment wetland can be designed with or without extended detention (above the permanent pool) to treat all or part of the water quality treatment volume. If extended detention is provided, the drawdown time shall be between 36 to 48 hours.

***Geometry and Size***

1. If there is no extended detention provided, wet retention basins shall be sized to provide a minimum wet pool volume equal to the water quality design volume plus an additional 5% for sediment accumulation. If extended detention is provided above the permanent pool and the basin is designed for water quality treatment only, then the permanent pool volume shall be a minimum of 10 percent of the water quality design volume and the surcharge volume (above the permanent pool) shall make up the remaining 90 percent. If extended detention is provided above the permanent pool and the basin is designed for water quality treatment and peak flow attenuation, then the permanent pool volume shall be equal to the water quality treatment volume and the surcharge volume shall be sized to attenuate peak flows to meet the peak runoff discharge requirements. The extended detention portion of the wet retention basin above the permanent pool, if provided, functions like a dry extended detention (ED) basin (see Section 6.10.3 for dry ED basin sizing guidelines).
2. The wet retention basin shall be divided into two cells separated by a berm or baffle. The first cell shall contain between 25 to 35 percent of the total volume. The berm or baffle volume shall not count as part of the total volume. *Intent: The full-length berm or baffle reduces short-circuiting and promotes plug flow. Use of a pipe and full-width manifold system to introduce water into the second cell is possible on a case-by-case basis if deemed necessary and approved by the City.*
3. Wet retention basins with wetpool volumes less than or equal to 4,000 cubic feet may be single-celled (i.e., no baffle or berm is required).
4. Sediment storage shall be provided in the first cell. The sediment storage shall have a minimum depth of 1 foot. This volume shall not be included as part of the required water quality volume.
5. The minimum depth of the first cell shall be 4 feet, exclusive of sediment storage requirements. The depth of the first cell may be greater than the depth of the second cell.
6. The maximum depth of each cell shall not exceed 8 feet (exclusive of sediment storage in the first cell).
7. For wet retention basin depths in excess of 6 feet, some form of recirculation shall be provided, such as a fountain or aerator, to prevent stratification, stagnation and low dissolved oxygen conditions.



8. Interior side slopes above the permanent pool shall be 4:1 (H:V).
9. The edge of the basin shall slope from the surface of the permanent pool to a depth of 12 to 18 inches at a slope of 1:1 or greater. If soil conditions will not support a 1:1 (H:V) slope then the steepest slope that can be supported shall be used or a shallow retaining wall constructed (18 inch max). Beyond the edge of the basin, a bench sloped at 4:1 (H:V) maximum shall extend into the basin to a depth of at least 3 feet. A steeper slope may be used beyond the 3 foot depth to a maximum of 8 feet. *Intent: steep slopes at waters edge will minimize very shallow areas that can support mosquitoes.*
10. At least 25% of the basin area shall be deeper than 3 feet to prevent the growth of emergent vegetation across the entire basin. If greater than 50% of the wet pool area is in excess of 6 feet deep, some form of recirculation shall be provided, such as a fountain or aerator, to prevent stratification, stagnation and low dissolved oxygen conditions.
11. A wet retention basin shall have a surface area of not less than 0.3 acres for each acre-foot of permanent pool volume. In addition, extra area needed to provide a design that meets all other provisions of this section shall be provided. Additional surface area in excess of the minimum may be provided. There is no maximum surface area provided that all provisions of this section are met.
12. Inlets and outlets shall be placed to maximize the flowpath through the facility. The flowpath length-to-width ratio shall be a minimum of 1.5:1, but a flowpath length-to-width ratio of 2:1 or greater is preferred. The flowpath length is defined as the distance from the inlet to the outlet, as measured at mid-depth. The width at mid-depth can be found as follows:  $\text{width} = (\text{average top width} + \text{average bottom width})/2$ . *Intent: a long flowpath length will improve fine sediment removal.*
13. All inlets shall enter the first cell. If there are multiple inlets, the length-to-width ratio shall be based on the average flowpath length for all inlets.
14. The minimum freeboard shall be 1 foot above the maximum water surface elevation (2 feet preferred) for on-line basins and 1 foot above the maximum water surface elevation for on-line basins.
15. The maximum residence time for dry weather flows shall be 7 days. *Intent: Vector control.*

### ***Internal Berms and Baffles***

1. A berm or baffle shall extend across the full width of the wet retention basin and be keyed into the basin side slopes. If the berm embankments are greater than 4 feet in height, the berm must be constructed by excavating a key equal to 50% of the embankment cross-sectional height and width. This requirement may be waived if recommended by a licensed civil engineer for the specific site conditions. The geotechnical investigation must consider the situation in which one of the two cells is empty while the other remains full of water.
2. The top of the berm shall extend to the permanent pool surface or be one foot below the permanent pool surface to discourage public access. If the top of the berm is at the water

permanent pool surface, the side slopes must be 4H:1V. Berm side slopes may be steeper (up to 3:1) if the berm is submerged one foot.

3. If good vegetation cover is not established on the berm, erosion control measures shall be used to prevent erosion of the berm back-slope when the basin is initially filled.
4. The interior berm or baffle may be a retaining wall provided that the design is prepared and stamped by a licensed civil engineer. If a baffle or retaining wall is used, it shall be submerged one foot below the permanent pool surface to discourage access by pedestrians.
5. Internal earthen berms 6 feet high or less shall have a minimum top width 6 feet or as recommended by a civil engineer.

### ***Water Supply***

1. Water balance calculations shall be provided to demonstrate that adequate water supply will be present to maintain a pool of water during a drought year when precipitation is 50% of average for the site. Water balance calculations shall include evapotranspiration, infiltration, precipitation, spillway discharge, and dry weather flow (where appropriate).
2. Where water balance indicates that losses will exceed inputs, a source of water shall be provided to maintain the basin water surface elevation throughout the year. The water supply shall be of sufficient quantity and quality to not have an adverse impact on the wet retention basin water quality. Water that meets drinking water standards shall be assumed to be of sufficient quality.
3. Wet retention basin may be designed as seasonal ponds where the water balance and water supply conditions make it infeasible to sustain a permanent wet retention basin.

### ***Soils Considerations***

Wet retention basin implementation in areas with high permeability soils requires liners to increase the chances of maintaining a permanent pool in the basin. Liners can be either synthetic materials or imported lower permeability soils (i.e., clays). The water balance assessment shall determine whether a liner is required.

If low permeability soils are used for the liner, a minimum of 18 inches of native soil amended with good topsoil or compost (one part compost mixed with 3 parts native soil) must be placed over the liner (see soil amendment Section 5.10). If a synthetic material is used, a soil depth of 2 feet is recommended to prevent damage to the liner during planting.

### ***Buffer Zone***

A minimum of 25 feet buffer shall be provided around the top perimeter of the wet retention basin. The portion of the access road outside of the maximum water level may be included as part of the buffer.

### *Water Quality Design Features*

1. Wet retention basins that are located in publicly-accessible or highly visible locations shall include design features that will improve and maintain the quality of water within the BMP at a level suitable for the proposed location and uses of the surrounding area. Typical design features include aeration, pumped circulation, filters, biofilters, and other facilities that operate year-round to remove pollutants and nutrients. Water quality design features will result in higher quality water in the BMP and lower discharges of pollutants downstream.
2. Wet retention basins in publicly-accessible or highly visible locations shall have a maintenance plan that includes regular collection and removal of trash from the area within and surrounding the BMP.
3. If fencing is required for wet retention basins in publicly-accessible or highly visible locations, the fence can be designed to be aesthetically incorporated into the site and Shrubs (approved, California-adapted species) can be used to hide the fencing. See vegetation section below.

### *Energy Dissipation*

1. The inlet to the wet retention basin shall be submerged with the inlet pipe invert a minimum of two feet from the basin bottom (not including sediment storage). The top of the inlet pipe shall be submerged at least 1 foot, if possible. Intent: The inlet is submerged to dissipate energy of the incoming flow. The distance from the bottom is set to minimize resuspension of settled sediments. Alternative inlet designs that accomplish these objectives are acceptable.
2. Energy dissipation controls must also be used at the outlet from the wet retention basin unless the basin discharges to a storm water conveyance system or hardened channel.

### *Vegetation*

A plan shall be prepared that indicates how aquatic, temporarily submerged areas (extended detention wet retention basins) and terrestrial areas will be stabilized with vegetation.

1. If the second cell of the wet retention basin is 3 feet or shallower, the bottom area shall be planted with emergent wetland vegetation.
2. Emergent aquatic vegetation shall be planted to cover 25-75% of the area of the permanent pool.
3. Outside of the basin, native vegetation adapted for site conditions shall be used in non-irrigated sites.
4. The area surrounding a wet retention basin must be landscaped to minimize erosion and must adhere to the following criteria so as not to hinder maintenance operations:

5. No trees or shrubs may be planted within 15 feet of inlet or outlet pipes or manmade drainage structures such as spillways, flow spreaders, or earthen embankments. Species with roots that seek water, such as willow or poplar, shall not be used within 50 feet of pipes or manmade structures. Weeping willow (*Salix babylonica*) shall not be planted in or near detention basins.
6. Prohibited non-native plant species will not be permitted. For more information on invasive weeds, including biology and control of listed weeds, look at the encyclopedias located at the California Department of Food and Agriculture website- [http://www.cdfa.ca.gov/phpps/ipc/encyclopedias/encyclopedias\\_hp.htm](http://www.cdfa.ca.gov/phpps/ipc/encyclopedias/encyclopedias_hp.htm) or the California Invasive Plant Council website at [www.cal-ipc.org](http://www.cal-ipc.org).
7. See Appendix G for a recommended native plant list for wet retention basins, a list of local nurseries where these plants can be purchased, and a list of local and regional on-line resources. The plant list shall be used as a guide only and shall not replace project-specific planting recommendations provided by a landscape professional including recommendations on appropriate plants, fertilizer, mulching applications, and irrigation requirements (if any) to ensure healthy vegetation growth. See Section 5.11 for more information on landscaping/planting recommendations and Section 5.10 for more information on soil amendment recommendations.

### ***Outlet Structure***

1. An outlet pipe and outlet structure shall be provided. The outlet pipe may be a perforated standpipe strapped to a manhole (see Figure 6-25) or placed in an embankment, suitable for extended detention, or may be back-sloped to a catch basin with a grated opening (jail house window) or manhole with a cone grate (birdcage) (see Figure 6-26). The grate or birdcage openings provide an overflow route should the basin outlet pipe become clogged.
2. For extended detention wet retention basin, outlet structures shall be designed to provide 12 to 48 hour emptying time for the water quality volume above the permanent pool.
3. The basin outlet pipe shall be sized, at a minimum, to pass flows greater than the water quality design peak flow for off-line basins or flows greater than the peak runoff discharge rate for the 100-year, 24-hr design storm for on-line basins.
4. See the dry extended detention section (Section 6.10.3) and Appendix E for further detail on outlet sizing.

### ***Emergency Spillway***

An emergency overflow spillway in addition to the primary overflow outlet (as described above) is required. The emergency spillway shall be sized for flows greater than the peak 100-year 24-hour storm if the basin is designed on-line or, if the basin is designed on-line, the spillway shall be sized for flows greater than the basin design volume (e.g., water quality design volume). The spillway shall be constructed with reinforced concrete and provide for adequate energy dissipation downstream. The spillway shall allow for at least 12 inches of freeboard above the

emergency overflow water surface elevation if the basin is on-line. If the basin is on-line, 2 feet of freeboard is preferable.

Spillways shall meet the California Department of Water Resources, Division of Safety of Dams Guidelines for the Design and Construction of Small Embankment Dams (<http://www.water.ca.gov/damsafety/docs/GuidelinesSmallDams.pdf>). *Intent: Emergency overflow spillways are intended to control the location of basin overtopping and safely direct overflows back into the downstream conveyance system or other acceptable discharge point.*

#### On-line Basins

1. On-line basins must have an emergency overflow spillway to prevent overtopping of walls or berms should blockage of the primary outlet occur based on a downstream risk assessment.
2. The overflow spillway must be sized to pass flows greater than the design peak runoff discharge rate for the 100-yr, 24-hr storm.
3. The minimum freeboard shall be 1 foot (but preferably at least 2 feet) above the maximum water surface elevation over the emergency spillway.

#### Off-line Basins

1. Off-line basins must have either an emergency overflow spillway or an emergency overflow riser. The emergency overflow must be designed to pass flows greater than the basin design volume (e.g., water quality design volume) directly to the downstream conveyance system or another acceptable discharge point. Where an emergency overflow spillway would discharge to a steep slope, an emergency overflow riser, *in addition* to the spillway shall be provided. See Appendix E for further detail on basin/pond outlet sizing.
2. The emergency overflow spillway shall be armored to withstand the energy of the spillway flows (Figure 6-32). The spillway shall be constructed of grouted rip-rap.
3. The minimum freeboard shall be 1 foot above the maximum water surface elevation over the emergency spillway.

#### ***Side Slopes***

1. Interior side slopes above the water quality design depth and up to the emergency overflow water surface shall be no steeper than 4:1 (H:V), unless stabilization has been approved by a licensed civil engineer and the City.
2. Exterior side slopes shall be no steeper than 2:1 (H:V), unless stabilization has been approved by a licensed civil engineer and the City.
3. For any slope (interior or exterior) steeper than 2:1 (H:V), a geotechnical investigation and report must be submitted and approved by the City.
4. Landscaped slopes must be no steeper than 3:1 (H:V) to allow for maintenance.

5. Basin walls may be vertical retaining walls, provided: (a) they are constructed of reinforced concrete, (b) a fence is provided along the top of the wall (see fencing below) or further back, and (c) the design is stamped by a licensed civil engineer and approved by the City.

### ***Embankments***

1. Earthworks and berm embankments shall be performed in accordance with the latest edition of the "Greenbook Standard Specifications for Public Works Construction".
2. Embankments are earthen slopes or berms used for detaining or redirecting the flow of water.
3. Top of berm shall be 2 feet minimum below the water quality design water surface and shall be keyed into embankment a minimum of 1 foot on both sides.
4. Typically, the top width of berm embankments are at least 20 feet, but narrower embankments may be plausible if approved by the civil engineer and the City.
5. Basin berm embankments must be constructed on native consolidated soil (or adequately compacted and stable fill soils analyzed by a licensed civil engineer) free of loose surface soil materials, roots, and other organic debris.
6. The berm embankment shall be constructed of compacted soil (95% minimum dry density, modified proctor method per ASTM D1557), placed in 6-inch lifts.
7. Basin berm embankments greater than 4 feet in height must be constructed by excavating a key equal to 50% of the berm embankment cross-sectional height and width. This requirement may be waived if specifically recommended by a licensed civil engineer.
8. The berm embankment shall be constructed of compacted soil (95% minimum dry density, modified proctor method per ASTM D1557), placed in 6-inch lifts.
9. Low growing native or non-invasive perennial grasses shall be planted on downstream embankment slopes. See vegetation section below.

### ***Fencing***

Safety is provided either by fencing of the facility or by managing the contours of the basin to eliminate drop-offs and other hazards.

1. In accordance with the Santa Barbara Flood Control District *Standard Conditions of Project Plan Approval*, facilities to be dedicated to the City, perimeter fencing (minimum height of 42 inches) shall be required on all basins exceeding two feet in depth or where interior side slopes are steeper than 6:1 (H:V).
2. If fences are required, fences shall be designed and constructed in accordance with current policies of the Santa Barbara County Flood Control District and must be located at or above the overflow water surface elevation. Shrubs (approved, California-adapted species) can be used to hide the fencing. See vegetation section above.

***Right-of-Way***

1. Constructed treatment wetlands and associated access roads to be maintained by the City shall be dedicated in fee or in an easement to the City with appropriate access.

***Maintenance Access***

1. Ownership of the basin and maintenance thereof is the responsibility of the developer/applicant. A maintenance agreement with the City is required to ensure adequate performance and allow the City emergency access to the facilities.
2. Maintenance access road(s) shall be provided to the control structure and other drainage structures associated with the basin (e.g., inlet, emergency overflow or bypass structures). Manhole and catch basin lids must be in or at the edge of the access road.
3. A graded 16-foot wide access ramp into the basin shall be constructed near the basin outlet. An access ramp is required for removal of sediment with a backhoe or loader and truck. The ramp must extend to the basin bottom to avoid damage to vegetation planted on the basin slope. A 16-foot wide commercial driveway approach shall be provided where curb and gutter front the maintenance ramp.
4. All access ramps and roads shall be provided in accordance with the current policies of the Flood Control District.

***Vector Control***

1. A Mosquito Management Plan or Service Contract must be approved or waived by the Santa Barbara Coastal Vector Control District for any facility that maintains a pool of water for 72 hours or more.

***Design Requirements Specific to Lakes***

Lakes designed to provide treatment may be used for storm water quality management, but will not be publicly maintained. Many of the wet retention basin design specifications discussed above are applicable to lakes such as the outlet works and maintenance access, but specific design features are also required. For example, a consistent water supply is required to maintain the wet pool in the lake year-round and to flush the system during spring and fall turnover to reduce the potential for the build-up of salts and nutrients in the lake. The wet retention basin shall also be sized as three times the water quality design volume so that the water quality does not drastically fluctuate during such events. Lakes shall also have depths greater than 8 feet, and preferably up to 15 feet at the center, to reduce light penetration, maintain a lower average temperature, allow for temperature stratification, and minimize evaporation. Lakes may be exempt from the fencing requirements applicable to wet retention basins if they exceed one acre in surface area and are used for recreational purposes. Additional design elements specific to lakes to provide storm water treatment and to maintain the water quality in the lake include wetland planters, lake biofilter beds, dry weather flow pretreatment, aeration, and storm water retention.

Submerged wetland planters may be constructed on shelves or floating rafts within the lake to assist in promoting overall water quality through filtering. Lake biofilters, through which lake

water is circulated and distributed by a slotted-pipe system, shall consist of separate, self-contained, submerged gravel beds placed at terminal ends of the lake geometry. A naturally occurring biomass of microorganisms coats the gravel and reduces nutrients that would otherwise promote algae growth in the lake. Pretreatment filters also shall be provided to treat all dry weather flows prior to entering the lake. In addition, fine-bubble diffusion aerators and recirculation pumping shall be installed to reintroduce oxygen into the system and increase overall dissolved-oxygen content. Adequate capacity shall be provided in the lake to maintain a permanent pool, retain the water quality design storm, and provide storage of runoff for irrigation reuse.

#### **6.10.2.4      Construction Considerations**

The use of treated wood or galvanized metal anywhere inside the facility is prohibited. The use of galvanized fencing is permitted if in accordance with the Fencing requirement above.



Figure 6-24: Wet Retention Basin Schematic

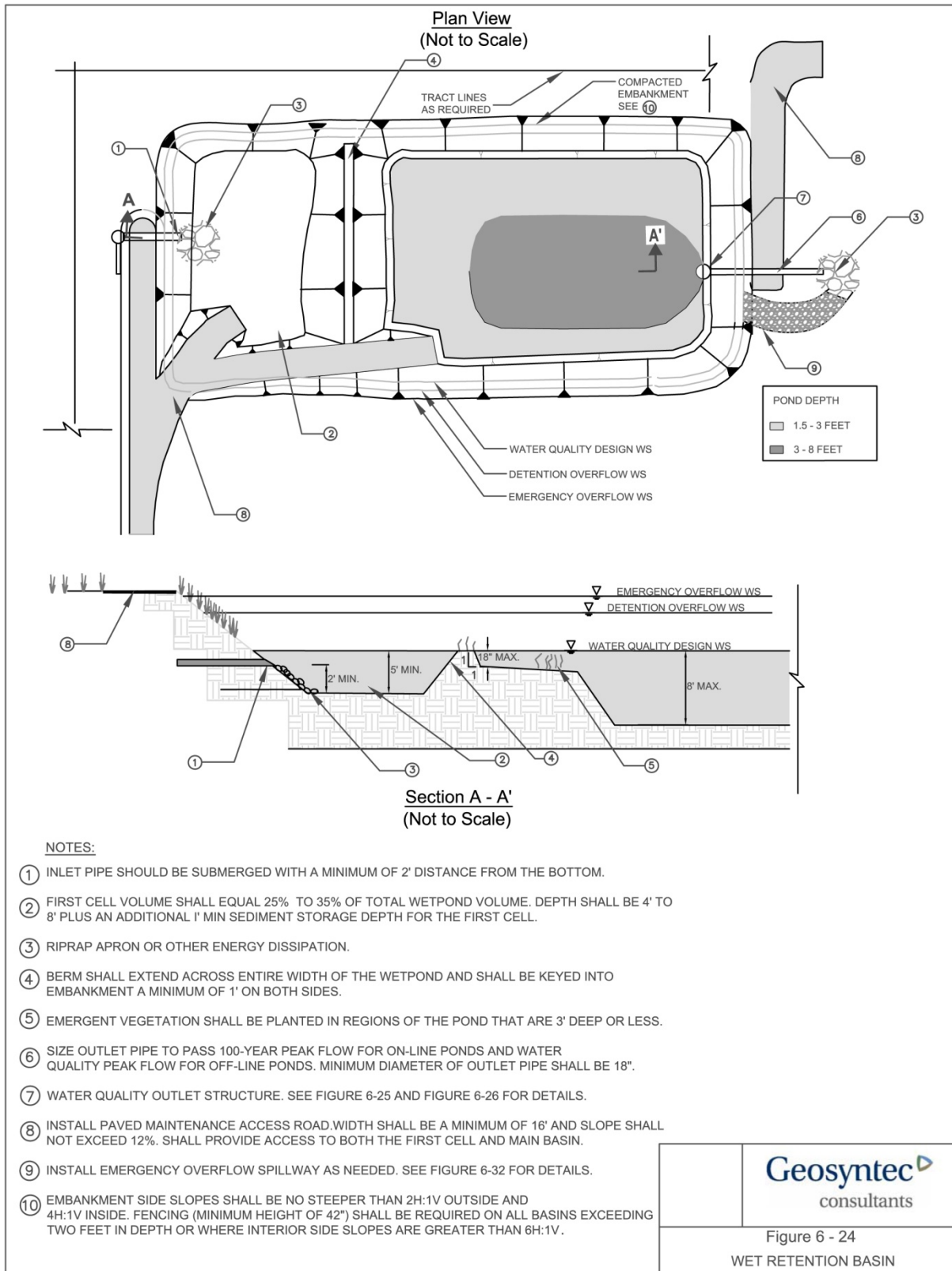

Figure 6-25: Riser Outlet Schematic – Option 1

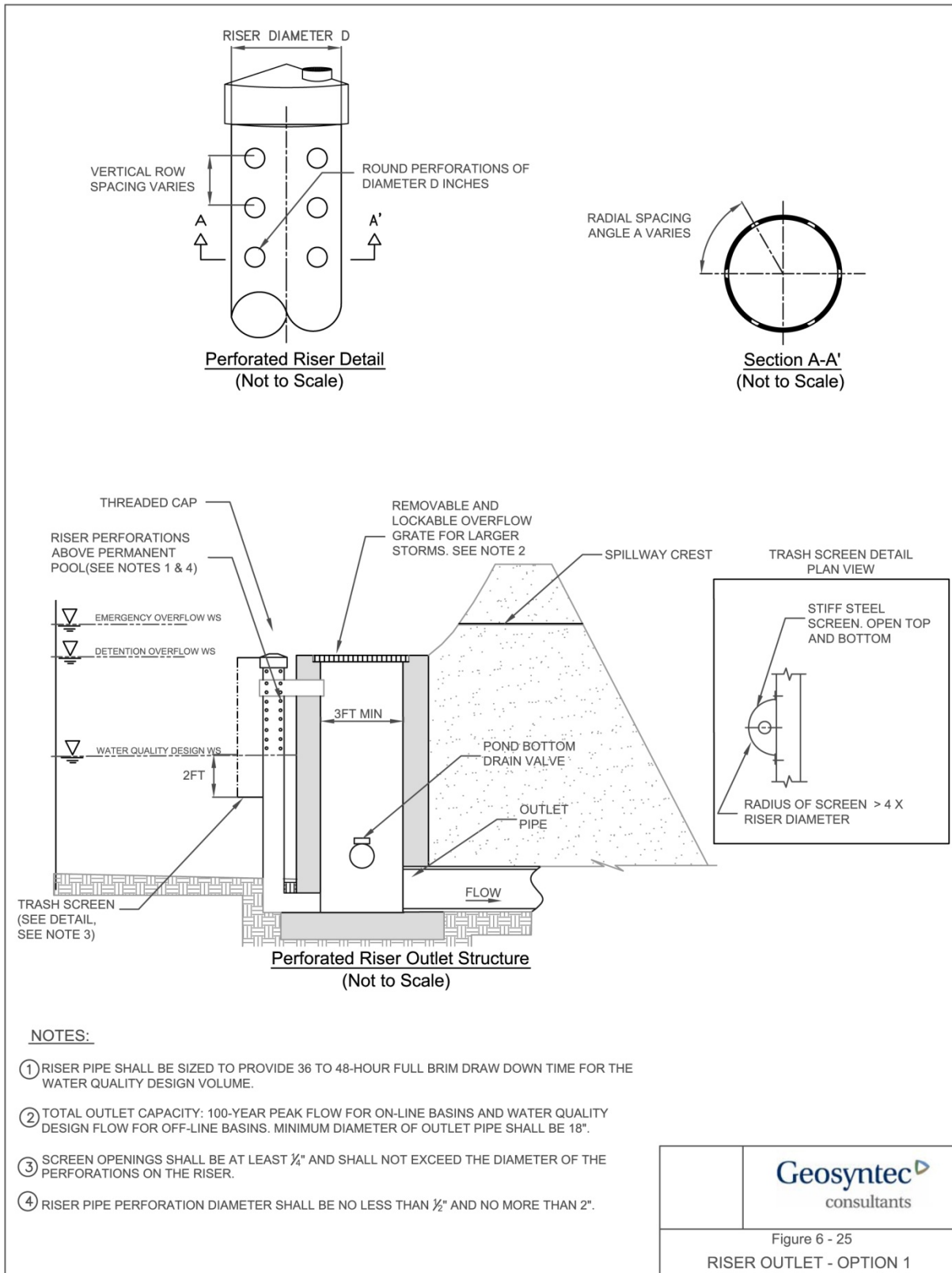
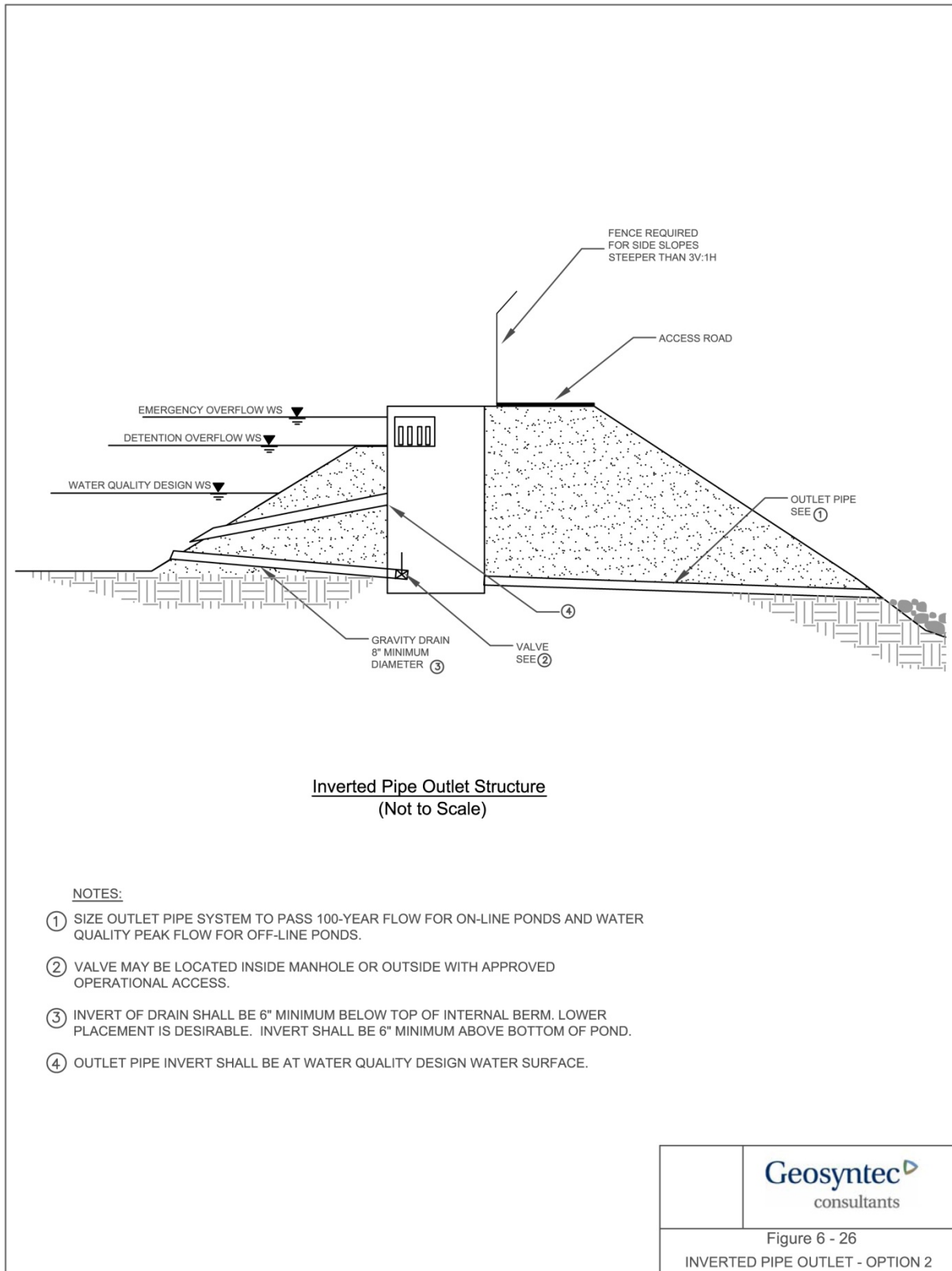

Figure 6-26: Inverted Pipe Outlet Schematic – Option 2



### 6.10.2.5 Operations and Maintenance

#### *General Requirements*

Maintenance is of primary importance if wet retention basins are to continue to function as originally designed. A specific maintenance plan shall be formulated for each facility outlining the schedule and scope of maintenance operations, as well as the data handling and reporting requirements. The following are general maintenance requirements:

1. The wet retention basin shall be inspected at a minimum annually and inspections after major storm events are encouraged (see Appendix H for a wet retention basin inspection and maintenance checklist). Trash and debris shall be removed as needed, but at least annually prior to the beginning of the wet season.
2. Site vegetation shall be maintained as frequently as necessary to maintain the aesthetic appearance of the site, and as follows:
3. Vegetation, large shrubs, or trees that limit access or interfere with basin operation shall be pruned or removed.
4. Slope areas that have become bare shall be revegetated and eroded areas shall be regraded prior to being revegetated.
5. Grass shall be mowed and grass clippings shall be removed.
6. Fallen leaves and debris from deciduous plant foliage shall be raked and removed.
7. Invasive vegetation, such as Alligatorweed (*Alternanthera philoxeroides*), Halogeton (*Halogeton glomeratus*), Spotted Knapweed (*Centaurea maculosa*), Giant Reed (*Arundo donax*), Castor Bean (*Ricinus communis*), Perennial Pepperweed (*Lepidium latifolium*), and Yellow Starthistle (*Centaurea solstitialis*) must be removed and replaced with non-invasive species. For more information on invasive weeds, including biology and control of listed weeds, look at the encyclopedias located at the California Department of Food and Agriculture website- [http://www.cdfa.ca.gov/phpps/ipc/encycloweedia/encycloweedia\\_hp.htm](http://www.cdfa.ca.gov/phpps/ipc/encycloweedia/encycloweedia_hp.htm) or the California Invasive Plant Council website at [www.cal-ipc.org](http://www.cal-ipc.org).
8. Dead vegetation shall be removed if it exceeds 10% of area coverage. Vegetation shall be replaced immediately to maintain cover density and control erosion where soils are exposed.
9. Sediment buildup exceeding 1.5 inches in the first cell shall be removed (or 6 inches above the sediment storage depth which is recommended to be 1 foot). Sediment from the second basin cell shall be removed when 6 inches of sediment accumulates.
10. Sediments shall be tested for hazardous substance accumulation in compliance with current disposal requirements if land uses in the catchment include commercial or industrial zones, or if visual or olfactory indications of pollution are noticed.

11. Following sediment removal activities, replanting, and/or reseeding of vegetation may be required for reestablishment.

### ***Maintenance Standards***

A summary of the routine and major maintenance activities recommended for wet retention basins is shown in Table 6-69. Routine and major maintenance standards listed in Table 6-70 and Table 6-71 are intended to be measures to determine if maintenance actions are required as identified through inspection. They are not intended to be measures of the facility's required condition at all times between inspections. In other words, exceedance of these thresholds or measures at any time between inspections and/or scheduled maintenance does not constitute a violation of these standards. These standards are violated only when an inspection identifies required maintenance action that has not been scheduled before the next regular inspection.

**Table 6-69: Wet Retention Basin Maintenance Quick Guide**

| <b>Inspection and Maintenance Activities Summary</b> |   |
|--|---|
| <b>Routine Maintenance</b>                           | <ul style="list-style-type: none"> <li>• Trash and debris removal</li> <li>• Remove minor sediment accumulation near inlet and outlet structures</li> <li>• Stabilize/repair eroded banks and fill in animal burrows if present</li> <li>• Remove any evidence of visual contamination from floatables such as oil and grease</li> <li>• Eliminate pests and conditions suitable for creating ideal breeding habitat</li> <li>• Remove algae mats as often as needed to prevent coverage of more than 20% of basin surface</li> <li>• Mow berms routinely if applicable to maintain aesthetic appeal and to suppress weeds</li> <li>• Periodically observe function under wet weather conditions</li> <li>• Photographs taken before and after maintenance is encouraged</li> </ul>   |
| <b>Major Maintenance</b>                             | <ul style="list-style-type: none"> <li>• Remove dead, diseased, or dying trees and woody vegetation that interfere with facility maintenance</li> <li>• Install or repair basin liner to ensure that first cell maintains a permanent pool</li> <li>• Correct problems associated with berm settlement</li> <li>• Remove trees, large shrubs and roots from downstream slope of embankments.</li> <li>• Repair berm/dike breaches and stabilize eroded parts of the berm</li> <li>• Repair and rebuild spillway as needed to correct severe erosion damage</li> <li>• Remove sediment build up in forebay and main basin area to restore original sediment holding capacity</li> <li>• Re-grade main basin bottom to restore bottom slope and eliminate the incidence of standing pools</li> <li>• Aerate compacted areas to promote infiltration if volume reductions are desired</li> <li>• Repair or replace gates, fences, flow control structures, and inlet/outlet structures as needed to maintain full functionality</li> </ul> |

**Table 6-70: Routine Maintenance Standards – Wet Retention Basin**

| Defect                | Conditions When Maintenance Is Needed   | Results Expected When Maintenance Is Performed   | Frequency   |
|-----------------------|---|--|---|
| Trash & Debris        | Any trash and debris which exceed 5 cubic feet per 1,000 sf of basin area (one standard garbage can) or if trash and debris is excessively clogging the outlet structure.<br>If less than threshold all trash and debris will be removed as part of next scheduled maintenance. | Trash and debris cleared from site.  | Annually prior to wet season<br><br>After major storm events (>0.75 in/24 hrs) if spot checks of some basins indicate widespread damage/maintenance needs |
| Sediment Accumulation | Sediment accumulation in basin bottom that exceeds the depth of the design sediment zone plus 6 inches, usually in the first cell.  | Sediment cleaned out.  |   |
| Erosion               | Erosion of basin's side slopes and/or scouring of basin bottom.   | Slopes shall be stabilized using appropriate erosion control measure(s) and repair methods.  |   |
| Oil Sheen on Water    | Prevalent and visible oil sheen.  | Oil sheen removed using absorbent boom or skimmer.   |   |
| Noxious Pests         | Visual observations or receipt of complaints of numbers of pests that would not be naturally occurring and could pose a threat to human or aquatic health.  | Vectors controlled per Santa Barbara Coastal Vector Control District. A Mosquito Management Plan or Service Contract must be presented to the Vector Management District for any facility that maintains a pool of water for 72 hours or more. |   |
| Water Level           | First cell empty, doesn't hold water.   | Line the first cell to maintain at least 4 feet of water. Although the second cell may drain, the first cell must remain full to control turbulence of the incoming flow and reduce sediment resuspension.                                     |   |
| Algae Mats            | Algae mats over more than 20% of the water surface.   | Algae mats removed using rake or other skimming device.  |   |

| Defect        | Conditions When Maintenance Is Needed                                | Results Expected When Maintenance Is Performed  | Frequency   |
|---------------|--|---|---|
| Aesthetics    | Minor vegetation removal and thinning. Mowing berms and surroundings | Facility is well kept.  | Monthly (or as dictated by agreement between County and landscape contractor) |
| Noxious Weeds | Any evidence of noxious weeds.                                       | Eradicate all noxious weeds; control and prevent the spread of all noxious weeds. Use Integrated Pest Management techniques, if applicable. See <a href="http://www.ipm.ucdavis.edu">http://www.ipm.ucdavis.edu</a> for more information. |   |

Table 6-71: Major Maintenance Standards – Wet Retention Basin

| Defect              | Conditions When Maintenance Is Needed  | Results Expected When Maintenance Is Performed   | Frequency   |
|---------------------|--|--|---|
| Tree Growth         | Tree growth does not allow maintenance access or interferes with maintenance activity (i.e., slope mowing, silt removal, vactoring, or equipment movements). If trees are not interfering, do not remove. Dead, diseased, or dying trees shall be removed. | Trees do not hinder maintenance activities. Remove dead, diseased, or dying trees. (Use a certified Arborist to determine health of tree or removal requirements). | Annual or as needed (infrequent)<br>After major storm events (>0.75 in/24 hrs) if spot checks of some basins indicate widespread damage/ maintenance needs. |
| Settling of Berm    | If settlement is apparent. Settling can be an indication of more severe problems with the berm or outlet works. A civil engineer shall be consulted to determine the source of the settlement if the dike/berm is serving as a dam.                        | Dike is built back to the design elevation.  |   |
| Piping through Berm | Discernable water flow through basin berm. Ongoing erosion with potential for erosion to continue. A licensed civil engineer shall be called in to inspect and evaluate condition and recommend repair of condition.                                       | Piping eliminated. Erosion potential resolved and berm stability achieved.   |   |

| Defect   | Conditions When Maintenance Is Needed   | Results Expected When Maintenance Is Performed  | Frequency |
|--|---|---|-----------|
| Tree and Large Shrub Growth on Downstream Slope of Embankments | Tree and large shrub growth on downstream slopes of embankments may prevent inspection and provide habitat for burrowing rodents. | Trees and large shrubs shall be removed. All dead roots shall be removed if practical. Otherwise, dead roots shall be removed to a minimum of 36 inches below grade and replaced with cement grout to 12 inches below grade. The top 12 inches of the root holes shall be filled with compacted, in-situ soils. The area facility engineer may require additional root removal if necessary for dam safety or maintenance purposes. |           |
| Erosion on Spillway  | Rock is missing and soil is exposed at top of spillway or outside slope.  | Rocks and pad depth are restored to design standards.   |           |
| Gate/Fence Damage  | Damage to gate/fence, including missing locks and hinges  | Gate/Fence repaired.  |           |



### 6.10.3 Dry Extended Detention Basins



**Figure 6-27: Dry ED Basin (dual use; playing field when dry)**

#### 6.10.3.1 Description

Dry extended detention (ED) basins (e.g., dry ponds, extended detention basins, detention ponds, or extended detention ponds) are basins whose outlets have been designed to detain the water quality design volume,  $V_{wq}$ , for 36 to 48 hours to allow sediment particles and associated pollutants to settle and be removed. Dry ED basins do not have a permanent pool; they are designed to drain completely between storm events. They can also be used to provide hydromodification and/or flood control by modifying the outlet control structure and providing additional detention storage. Where soil conditions allow, they can also be modified to achieve volume reduction goals by including a sand filter layer beneath the basin to detain and infiltrate additional runoff. The slopes, bottom, and forebay of dry ED basins are typically vegetated. Without the addition of a sand filter beneath the basin, considerable storm water volume reduction can still occur, depending on the infiltration capacity of the subsoil. Data from the International BMP Database have shown that as much as 30 percent of storm water volume captured by dry extended detention basins can be lost to infiltration (Strecker et al., 2004).

Dry ED basins can be designed either on-line or off-line. If it is designed just for water quality treatment, it is recommended that the basin be off-line from flood conveyance. For off-line basins, a flow diversion structure (i.e., flow splitter) is used to divert the water quality design volume to the basin. For on-line basins, storm events exceeding the water quality design volume will be routed through the basin and discharged from a primary overflow structure at rates that do not exceed pre-development rates for storms up to the 100-year, 24-hr design storm. Storm events that exceed the 100-year design storm will exit the basin over an emergency spillway. If basins are to be on-line, they must be designed to pass the appropriate flood without damage to the basin, as well as to minimize re-entrainment of pollutants. In both

#### Applications

- Roads and highways
- Commercial developments
- Office building developments
- Multi-family developments

#### Performance/Advantages

- Efficient removal of pollutants adsorbed to sediments
- Potentially significant volume mitigation

#### Limitations

- Requires large tributary area
- Must be sited in areas where current flood control structures are not adversely affected

types of basins, influent flows enter a sediment forebay where coarse solids are first removed prior to flowing into the main cell of the basin where finer sediment and associated pollutants settle as storm water is detained and slowly released through a controlled outlet structure. Dry weather flows and very low storm flows are often infiltrated within the basin. If standing water is a concern due to dry weather flows, a low flow drain can be installed to convey the dry weather flows out of the basin and to another storm water runoff BMP, storm water conveyance system, or other acceptable discharge point.

### 6.10.3.2 Performance, Applicability, and Limitations

Table 6-72, Table 6-73, and Table 6-74 provide a summary of BMP performance, applicability, and limitations for dry ED basins. *It is important to note that information in these tables shall be used to provide general guidance for dry ED basins and shall not replace the evaluation performed by a water quality professional.*

#### Applicability and Performance

Table 6-72 and associated guidance provide general volume reduction capabilities and treatment effectiveness for dry ED basins. Refer to Section 6.4 for the process that shall be used for selecting BMPs based on pollutants of concern. Refer to Table 6-1 to determine the ranking of constructed treatment wetlands for removal of pollutants of concern as compared with other storm water runoff BMPs provided in Chapter 6. Refer to Table 6-2 to assess the applicability of constructed treatment wetlands for your site based on site suitability considerations as compared with other storm water runoff BMPs provided in Chapter 6. Dry extended detention basins are volume-based BMPs intended to provide: (1) water quality treatment, (2) varying levels of volume reduction depending on site conditions and design, and (3) control of the peak runoff discharge rate (see Table 6-72). Dry weather flows and small storm flows are often infiltrated within the basin. If site conditions allow, a hybrid sand filter or planting media layer placed beneath the dry extended detention basin (as described in this section), can be designed to increase the infiltration capacity of the basin. In this hybrid case or when the detention basin is underlain by infiltrative soils, credit can be gained towards meeting the volume reduction requirement,  $V_{\text{reduction}}$ , as described below in the basin sizing section. See Section 6.2 for specific storm water runoff requirements for Tier 3 projects.

**Table 6-72: Volume Reduction & Treatment Effectiveness for Dry ED Basins**

| Storm Water Runoff BMP   | Volume Mitigation (% of inflow) | Treatment Effectiveness for Pollutants of Concern <sup>1</sup> |           |          |  |          |  |
|--|---------------------------------|--|-----------|----------|--|----------|--|
|  |                                 | Trash  | Nutrients | Bacteria | Metals (particulate and dissolved fractions) | Sediment | Organics (hydrocarbons, oil, and grease) |
| Dry Extended Detention Basin   | ●                               | ◐  | ◑         | ◐        | ◑  | ●        | ●  |
| Volume/Treatment Effectiveness: ● = Very High, ◐ = High, ◑ = Moderate, ◒ = Low, ○ = Very Low |                                 |  |           |          |  |          |  |

<sup>1</sup> Effectiveness may change based on design variations; standard BMP designs have been assumed.

Water quality treatment is provided in the sediment forebay and the main cell. The sediment forebay provides removal of coarse solids prior to flow entering the main cell of the basin where finer sediment and associated pollutants settle as storm water is detained and slowly released through a controlled outlet structure.

### *Site Suitability Recommendations and Limitations*

Table 6-73 and associated guidance provide general considerations for assessing a site's suitability for dry ED basins.

**Table 6-73: Site Suitability Considerations for Dry Extended Detention Basins**

| BMP                          | Tributary Area (Acres) <sup>1</sup> | Site Slope (%)    | Depth to Seasonally High Groundwater Table (ft)   | Hydrologic Soil Group | Horizontal Setback from Drinking Water Wells (ft)                   |
|------------------------------|-------------------------------------|-------------------|---|-----------------------|---|
| Dry Extended Detention Basin | > 5                                 | < 15 <sup>2</sup> | > 2 if infiltration is not significant; > 5 when basin is designed to achieve volume reduction requirements | Any                   | 100 when basin is designed to achieve volume reduction requirements |

<sup>1</sup> Tributary area is the area of the site draining to the BMP. Tributary areas provided here shall be used as a general guideline only. Tributary areas can be larger or smaller in some instances.

<sup>2</sup> If slope exceeds given limit or is within 200 feet from the top of a hazardous slope or landslide area, a geotechnical investigation is required.

Table 6-74 provides additional site applicability considerations for special design districts within the City including coastal bluff areas and hillside design districts.

**Table 6-74: Applicability of Dry ED Basins for Special Design Districts**

| Coastal Bluff Area                               | Hillside Design District   |
|--|--|
| Generally not acceptable in Coastal Bluff Areas. | Acceptable if: (1) a geotechnical investigation proves that the facility does not compromise the stability of the site slope or surrounding slopes, or (2) the facility meets the site slope criteria in Table 6-73 and the facility is fully contained with an impermeable liner and overflow to a storm water conveyance system. |

The following describes additional site suitability recommendations and limitations for dry extended detention basins.

- The tributary area associated with a dry ED basin shall be greater than 10 acres. Use of dry ED basins may be limited in high density locations where insufficient space is available to achieve reductions in storm water runoff discharge flow rate, volume, and/or pollutants.

- Site slope shall be less than 15% due to slope instability and landslide potential. If slopes exceed this limit, a geotechnical investigation is required.
- The location of dry ED basins shall not be within 200 feet from the top of a hazardous slope or landslide area. If so, a geotechnical investigation is required.
- For dry ED basins that do not have significant infiltration (i.e., not designed to achieve the volume reduction requirements), maximum groundwater levels shall be at least 2 ft lower than the bottom of the dry ED basin to prevent the base from remaining wet between storms. If the dry ED basin is designed for significant infiltration (i.e., designed to achieve the volume reduction requirements), maximum groundwater levels shall be at least 5 ft lower than the bottom of the basin to minimize water quality impacts to groundwater.
- Dry ED basins shall not be designed for significant infiltration in areas of high industrial activity or other locations where a heightened threat of groundwater contamination may exist.
- Dry ED basins shall not be placed within a blue-line (i.e., first order) stream.

#### ***Multi-Use and Treatment Train Opportunities***

A dry ED basin can sometimes be retrofitted into existing flood control basins or integrated into the design of a park, athletic field, or other green space. Hybrid dry ED basins that incorporate a sand filter or planting media underneath the basin are an option for increasing volume reduction. The hybrid dry ED basin and sand filter or planting media system can also have recreational use by using the system as a volleyball court. Both of these applications can encourage infiltration if site conditions allow and require significant pretreatment to remove coarse solids, trash and debris, and oil and grease. Perforated risers, multiple orifice plate outlets, or similar multi-stage outlets are required for flood control retrofit applications to ensure adequate detention time for small storms while still providing peak flow attenuation for the flood design storms. Recreational multi-use facilities must be inspected after every storm and may require a greater maintenance frequency than dedicated water quality basins as to ensure aesthetics and public safety are not compromised. Any planned multi-use facility may be required to obtain special approval from the City.

Dry ED basins can also be combined with other basic and storm water runoff BMPs to form a "treatment train" that provides enhanced water quality treatment and reductions in runoff volume and rate. For example, a vegetated swale can be placed upgradient of a dry ED basin, allowing the rate and volume of water flowing to the dry ED basin to be reduced and the water quality enhanced. As another example, dry ED basins may be placed upstream of a vegetated swale to reduce the size of the vegetated swale. In both cases, each facility can be reduced in size accordingly based upon demonstrated performance for meeting the storm water runoff requirements as outlined in Section 6.2 and addressing targeted pollutants of concern.

**6.10.3.3 Design Criteria and Procedure**

Dry ED basins shall be designed according to the current policies of the City and the County of Santa Barbara Flood Control District. Standard design criteria for dry ED basins are listed in Table 6-75.

**Table 6-75: Dry Extended Detention Basin Design Criteria**

| Design Parameter  | Unit       | Design Criteria                           |
|---|------------|---|
| Maintaining peak runoff discharge rate requirement          | cfs        | See Section 6.2.1 and Appendix C          |
| Design volume reduction requirement, $V_{\text{reduction}}$ | acre-feet  | See Section 6.2.2 and Appendix C          |
| Water quality design volume, $V_{\text{wq}}$                | acre-feet  | See Section 6.2.3 and Appendix C          |
| Forebay basin size  | acre-feet  | 25% of total basin volume                 |
| Drawdown time for $V_{\text{wq}}$                           | hours      | Top 50%: 12-16 hrs; Bottom 50%: 24-32 hrs |
| Freeboard (minimum)   | inches     | 12; for off-line facilities               |
| Flow path length to width ratio                             | L:W        | 3:1; can be achieved using internal berms |
| Side slope (maximum)  | H:V        | 4:1 (H:V) Interior and 2:1 (H:V) Exterior |
| Longitudinal slope  | percentage | 1 (forebay) and 0-2 (main basin)          |
| Low flow channel geometry <sup>1</sup>                      | feet       | Of 'sufficient size' (see footnote below) |
| Maintenance access ramp width                               | feet       | 16  |
| Minimum outflow device diameter                             | inches     | 18  |

***Sizing for Meeting the Storm Water Runoff Requirements***

Dry extended detention basins can be sized to meet all or part of the storm water runoff requirements as outlined in Section 6.2 and Appendix C. A schematic of a standard dry ED basin is illustrated in Figure 6-28. A dry ED basin sizing example is provided in Appendix D.

**Maintaining peak runoff discharge rate requirement**

The dry ED basin can be designed with sufficient storage to meet all or part of the peak runoff discharge requirement for the 2-year through the 100-year, 24-hr design storm.

**Volume reduction requirement**

If the dry ED basin is underlain by a subsoil with an infiltration of 0.5 in/hr or greater (as determined using the methods outlined in Chapter 3), a volume reduction of 15 percent of storm water volume captured by dry ED basin can be credited towards the volume reduction requirement,  $V_{\text{reduction}}$ .

If the dry ED basin is combined with a sand filter, a larger volume reduction can be credited towards the volume reduction requirement,  $V_{\text{reduction}}$ , based on the demonstrated design and performance of the system.

Water quality treatment volume requirement

The dry ED basin can be designed to treat the water quality treatment volume with a 36 to 48 hour drawdown time

***Geometry and Size***

1. The total basin volume shall be increased an additional 5% of the water quality design volume to account for sediment accumulation. If the basin is designed only for water quality treatment then the basin volume would be 105% of the water quality design volume,  $V_{wq}$ . Freeboard is in addition to the total basin volume.
2. The minimum freeboard shall be at least 1 foot above the emergency overflow water surface for dry extended detention basins.
3. The minimum flow-path length to width ratio at half basin height shall be a minimum of 3:1 (L:W) and can be achieved using internal berms or other means to prevent short-circuiting. *Intent: a long flow length will improve fine sediment removal.*
4. The cross-sectional geometry across the width of the basin shall be approximately trapezoidal with a maximum side slope of 4:1 (H:V) on interior slopes and 2:1 (H:V) on exterior slopes unless specifically permitted by the County (see Side Slopes below). Shallower side slopes are necessary if the basin is designed to have recreational uses during dry weather conditions.
5. All dry ED basins shall be free draining and a low flow channel shall be provided. A low flow channel is a narrow, shallow trench filled with pea gravel and encased with filter fabric that runs the length of the basin to drain dry weather flows. The low flow channel shall be of sufficient size considering the natural characteristics of the soil and have a positive-draining gradient flowing toward the outlet structure (typically 1 ft wide by 6 inches deep). If infiltration rates of subsurface soils are insufficient, the low flow channel shall tie into perforated pipe at the outlet structure. If a sand filter or planting media is provided beneath the dry ED basin for increased volume reduction, it may be designed to take the place of the low flow channel.
6. The basin bottom shall have a 1% longitudinal slope (direction of flow) in the forebay, and may range from 0 to 2% longitudinal slope in the main basin. The bottom of the basin shall slope 2% toward the center low flow channel.
7. A basin shall be large enough to allow for equipment access via a graded 16-foot wide access ramp. If the total basin volume is such that the basin bottom is less than 16 feet wide, an alternative BMP shall be considered or the Santa Barbara County Flood Control District shall be contacted for approval. See Maintenance Access below.

### ***Soils Considerations***

1. Dry ED basins can be used with almost all soils and geology, with minor design adjustments for rapidly percolating soils (sandy or gravelly soils with infiltration rate > 2.4 in/hr). If rapidly percolating soils are present, dry ED basins shall be lined with compacted low permeability soil or use another other type of liner to prevent rapid, untreated infiltration.
2. The slopes of the detention basin shall be analyzed for slope stability using rapid drawdown conditions and shall meet the minimum standards set by the Santa Barbara County Flood Control District. A 1.5 static factor of safety shall be used. Seismic analysis is not required due to the temporary storage of water in the basin.
3. The infiltration capability of the dry ED basin can be enhanced by incorporating soil amendments. See Section 5.10 for more information.

### ***Energy Dissipation***

1. Energy dissipation controls constructed of sound materials such as stones, concrete, or proprietary devices that are rated to withstand the energy of the influent flow shall be installed at the inlet to the sediment forebay. Flow velocity into the basin forebay shall be controlled to 4 feet per second (ft/sec) or less.
2. Energy dissipation controls must also be used at the outlet/spillway from the detention basin unless the basin discharges to a storm drain or hardened channel.

### ***Sediment Forebay***

As untreated storm water enters the dry ED basin, it passes through a sediment forebay for coarse solids removal. The forebay may be constructed using an internal berm constructed out of earthen embankment material, grouted riprap, stop logs, or other structurally sound material.

1. The basin shall be sized so that 25% of the total basin volume is in the forebay and 75% of the total basin volume is in the main portion of the basin.
2. A gravity drain outlet from the forebay (2" minimum diameter) must extend the entire width of the internal berm and be designed to completely drain to the main basin within 10 minutes.
3. The forebay outlet shall be offset (horizontally) from the inflow streamline to prevent short-circuiting.
4. Permanent steel post depth markers shall be placed in the forebay to define sediment removal limits at 50% of the forebay sediment storage depth.

### ***Vegetation***

Vegetation within the dry ED basin provides erosion protection from wind and water and biofiltration of storm water. The City shall review and approve any proposed basin landscape plan prior to implementation and following guidelines shall be followed:

1. The bottom and slopes of the dry ED basin shall be vegetated. A mix of erosion-resistant plant species that effectively bind the soil shall be used on the slopes and a diverse selection of plants that thrive under the specific site, climatic, and watering conditions shall be specified for the basin bottom. The basin bottom shall not be planted with trees, shrubs, or other large woody plants that may interfere with sediment removal activities. The basin shall be free of floating objects. Only native perennial grasses, forbs, or similar vegetation that can be replaced via seeding shall be used on the basin bottom.
2. Landscaping outside of the basin is required for all dry ED basins and must adhere to the following criteria so as not to hinder maintenance operations:
  - a. No trees or shrubs may be planted within 15 feet of inlet or outlet pipes or manmade drainage structures such as spillways, flow spreaders, or earthen embankments. Species with roots that seek water, such as willow or poplar, shall not be used within 50 feet of pipes or manmade structures. Weeping willow (*Salix babylonica*) shall not be planted in or near detention basins.
  - b. Prohibited non-native plant species will not be permitted. For more information on invasive weeds, including biology and control of listed weeds, look at the encyclopedias located at the California Department of Food and Agriculture website- [http://www.cdffa.ca.gov/phpps/ipc/encyclopedias/encyclopedias\\_hp.htm](http://www.cdffa.ca.gov/phpps/ipc/encyclopedias/encyclopedias_hp.htm) or the California Invasive Plant Council website at [www.cal-ipc.org](http://www.cal-ipc.org).
3. See Appendix G for a recommended native plant list for dry extended detention basins, a list of local nurseries where these plants can be purchased, and a list of local and regional on-line resources. The plant list shall be used as a guide only and shall not replace project-specific planting recommendations provided by a landscape professional including recommendations on appropriate plants, fertilizer, mulching applications, and irrigation requirements (if any) to ensure healthy vegetation growth. See Section 5.11 for more information on landscaping/planting recommendations and Section 5.10 for more information on soil amendment recommendations.

### ***Sand Filter or Planting Media Layer***

For increasing the volume reduction capability of a dry ED basin, an appropriately sized sand filter or planting media layer can be placed beneath the dry ED basin to achieve desired volume reduction goals if soil and slope conditions allow (i.e., infiltration rate greater than 0.05 in/hr but less than 2.4 in/hr; site slope less than 15%). The drawdown time of the sand filter or planting media layer shall be less than 72 hours. The base of the sand filter or planting media layer shall be level (i.e., zero slope). If a sand filter/planting media layer is provided over the length of the basin, it can take the place of the low-flow channel so long as it is designed to adequately infiltrate dry weather flows. Sizing of the sand filter and planting media layer for dry ED basins is the same as for sand filters and bioretention areas, respectively. See Sections 6.6.4



for sizing calculations for sand filters and Section 6.6.1 for sizing calculations for bioretention areas. The depth of water in the dry ED basin shall not exceed 6 feet.

### ***Outlet Structure and Drawdown Time***

A drawdown time of 36 to 48 hours shall be provided for the water quality design volume,  $V_{wq}$ . This drawdown time is for the volume in the basin above the sand filter layer (if provided) and serves the purpose of water quality treatment. An outflow device shall be designed to release the bottom 50% of the detention volume (half-full to empty) over 24 to 32 hours, and the top half (full to half-full) in 12 to 16 hours. *Intent: Drawdown schemes that detain low flows for longer periods than high flows have the following advantages over outlets that drain the basin evenly:*

- *Greater flood control capabilities*
- *Enhanced treatment of low flows which make up the bulk of incoming flows.*

Additional storage, detention, and outlet control is required to achieve pre-development storm water runoff discharge rates for the 2- through 100-year 24-hour storm events as required by the Santa Barbara County Flood Control District. The outlet structure can be designed to achieve flow control for meeting the multiple objectives of water quality and flow attenuation.

The outflow device (i.e., outlet pipe) shall be oversized (18 inch minimum diameter). There are two options that can be used for the outlet structure:

1. Uniformly perforated riser structures.
2. Multiple orifice structures (orifice plate).

The outlet structure can be placed in the basin with a debris screen (Figure 6-29) or housed in a standard manhole (Figure 6-30 and Figure 6-31). If a multiple orifice structure is used, an orifice restriction (if necessary) shall be used to limit orifice outflow to the maximum discharge rates allowable for achieving the desired water quality and flow control objectives. Orifice restriction plates shall be removable for emergency situations. A removable trash rack shall be provided at the outlet. Orifice plates and trash racks shall be galvanized. Mounting hardware shall utilize stainless steel bolts.

Note that a primary overflow (typically a riser pipe connected to the outlet works) shall be sized to pass flows larger than the water quality design storm (if the ED basin is sized only for water quality) or to pass flows larger than the peak flow rate of the maximum design storm to be detained in the basin (e.g., 100-yr, 24-hr). The primary overflow is intended to protect against overtopping or breaching of a basin embankment.

***Perforated Risers Outlet Sizing Methodology***

The following attributes influence the perforated riser outlet sizing calculations:

- Shape of the basin (e.g., trapezoidal)
- Depth and volume of the basin
- Elevation / depth of first row of holes
- Elevation / depth of last row of holes
- Size of perforations
- Number of rows or perforations and number of perforations per row
- Desired drawdown time (e.g., 16 hour and 32 hour draw down for top half and bottom half respectively, 48 hour total drawdown time for the water quality design volume)

The governing the rate of discharge from a perforated riser structure can be calculated using Equation 6-32 below:

$$Q = C_p \frac{2A_p}{3H_s} \sqrt{2gH}^{3/2} \quad (\text{Equation 6-32})$$

Where:

- Q = riser flow discharge (cfs)  
 C<sub>p</sub> = discharge coefficient for perforations (use 0.61)  
 A<sub>p</sub> = cross-sectional area of all the holes (ft<sup>2</sup>)  
 s = center to center vertical spacing between perforations (ft)  
 H<sub>s</sub> = distance from s/2 below the lowest row of holes to s/2 above the top row of holes (McEnroe 1988).  
 H = effective head on the orifice (measured from center of orifice to water surface)

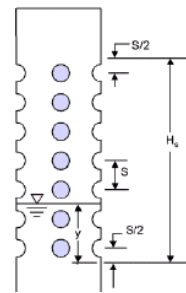

For the iterative computations needed to size the perforations in the riser and determine the riser height, a simplified version of Equation 6-32 may be used as shown below in Equation 6-33 and Equation 6-34:

$$Q = kH^{3/2} \quad (\text{Equation 6-33})$$

Where:

$$k = C_p \frac{2A_p}{3H_s} \sqrt{2g} \quad (\text{Equation 6-34})$$

Uniformly perforated riser designs are defined by the depth or elevation of the first row of perforations, the length of the perforated section of pipe, and the size or diameter of each perforation (Figure 6-29 and Figure 6-30). The steps needed to size a perforated riser outlet are illustrated in Appendix E.

### ***Multiple Orifice Outlet Sizing Methodology***

The following attributes influence multiple orifice outlet sizing calculations:

- Shape of the basin (e.g., trapezoidal)
- Depth and volume of the basin
- Elevation of each orifice
- Desired draw-down time (e.g., 16 hour and 32 hour draw down times for top half and bottom half respectively, 48 hour drawdown time for water quality design volume)

The rate of discharge from a single orifice can be calculated using Equation 6-35.

$$Q = CA(2gH)^{0.5} \quad \text{(Equation 6-35)}$$

Where:

- Q = orifice flow discharge
- C = discharge coefficient
- A = cross-sectional area of orifice or pipe (ft<sup>2</sup>)
- g = acceleration due to gravity (32.2 ft/s<sup>2</sup>)
- H = effective head on the orifice (measured from center of orifice to water surface)

Multiple orifice designs are defined by the depth (or elevation) and the size (or diameter) of each orifice (Figure 6-31). The steps needed to size a dual orifice outlet are outlined in Appendix E; multiple orifices may be provided and sized using a similar approach.

### ***Emergency Spillway***

An emergency overflow spillway in addition to the primary overflow outlet (as described above) is required. The emergency spillway shall be sized for flows greater than the peak 100-year 24-hour storm if the basin is designed on-line or, if the basin is designed on-line, the spillway shall be sized for flows greater than the basin design volume (e.g., water quality design volume). The spillway shall be constructed with reinforced concrete and provide for adequate energy dissipation downstream. The spillway shall allow for at least 12 inches of freeboard above the emergency overflow water surface elevation if the basin is on-line. If the basin is on-line, 2 feet of freeboard is preferable.

Spillways shall meet the California Department of Water Resources, Division of Safety of Dams Guidelines for the Design and Construction of Small Embankment Dams (<http://www.water.ca.gov/damsafety/docs/GuidelinesSmallDams.pdf>). *Intent: Emergency overflow spillways are intended to control the location of basin overtopping and safely direct overflows back into the downstream conveyance system or other acceptable discharge point.*

### On-line Basins

1. On-line basins must have an emergency overflow spillway to prevent overtopping of walls or berms should blockage of the primary outlet occur based on a downstream risk assessment.
2. The overflow spillway must be sized to pass flows greater than the design peak runoff discharge rate for the 100-yr, 24-hr storm.
3. The minimum freeboard shall be 1 foot (but preferably at least 2 feet) above the maximum water surface elevation over the emergency spillway.

### Off-line Basins

1. Off-line basins must have either an emergency overflow spillway or an emergency overflow riser. The emergency overflow must be designed to pass the 100-yr 24-hr post-development peak storm water runoff discharge rate directly to the downstream conveyance system or another acceptable discharge point. Where an emergency overflow spillway would discharge to a steep slope, an emergency overflow riser, *in addition* to the spillway shall be provided.
2. The emergency overflow spillway shall be armored to withstand the energy of the spillway flows (Figure 6-32). The spillway shall be constructed of grouted rip-rap.
3. The minimum freeboard shall be 1 foot above the maximum water surface elevation over the emergency spillway.

### ***Side Slopes***

1. Interior side slopes above the water quality design depth and up to the emergency overflow water surface shall be no steeper than 4:1 (H:V), unless stabilization has been approved by a licensed civil engineer and the City.
2. Exterior side slopes shall be no steeper than 2:1 (H:V), unless stabilization has been approved by a licensed civil engineer and the City.
3. For any slope (interior or exterior) greater than 2:1 (H:V), a geotechnical investigation and report must be submitted and approved by the City.
4. Landscaped slopes must be no greater than 3:1 (H:V) to allow for maintenance.
5. Basin walls may be vertical retaining walls, provided: (a) they are constructed of reinforced concrete, (b) a fence is provided along the top of the wall (see fencing below) or further back, and (c) the design is stamped by a licensed civil engineer and approved by the City.

### ***Embankments***

1. Earthworks and berm embankments shall be performed in accordance with the latest edition of the "Greenbook Standard Specifications for Public Works Construction".

2. Embankments are earthen slopes or berms used for detaining or redirecting the flow of water.
3. Top of berm shall be 2 feet minimum below the water quality design water surface and shall be keyed into embankment a minimum of 1 foot on both sides.
4. Typically, the top width of berm embankments are at least 20 feet, but narrower embankments may be plausible if approved by the civil engineer and the City.
5. Basin berm embankments must be constructed on native consolidated soil (or adequately compacted and stable fill soils analyzed by a licensed civil engineer) free of loose surface soil materials, roots, and other organic debris.
6. The berm embankment shall be constructed of compacted soil (95% minimum dry density, modified proctor method per ASTM D1557), placed in 6-inch lifts.
7. Basin berm embankments greater than 4 feet in height must be constructed by excavating a key equal to 50% of the berm embankment cross-sectional height and width. This requirement may be waived if specifically recommended by a licensed civil engineer.
8. The berm embankment shall be constructed of compacted soil (95% minimum dry density, modified proctor method per ASTM D1557), placed in 6-inch lifts.
9. Low growing native or non-invasive perennial grasses shall be planted on downstream embankment slopes. See vegetation section below.

### ***Fencing***

1. Safety is provided either by fencing of the facility or by managing the contours of the basin to eliminate drop-offs and other hazards.
2. In accordance with the Santa Barbara Flood Control District *Standard Conditions of Project Plan Approval*, facilities to be dedicated to the City, perimeter fencing (minimum height of 42 inches) shall be required on all basins exceeding two feet in depth or where interior side slopes are steeper than 6:1 (H:V).
3. If fences are required, fences shall be designed and constructed in accordance with current policies of the Santa Barbara County Flood Control District and must be located at or above the overflow water surface elevation. Shrubs (approved, California-adapted species) can be used to hide the fencing. See vegetation section above.

### ***Right-of-Way***

1. Constructed treatment wetlands and associated access roads to be maintained by the City shall be dedicated in fee or in an easement to the City with appropriate access.

***Maintenance Access***

1. Ownership of the basin and maintenance thereof is the responsibility of the developer/applicant. A maintenance agreement with the City is required to ensure adequate performance and allow the City emergency access to the facilities.
2. Maintenance access road(s) shall be provided to the control structure and other drainage structures associated with the basin (e.g., inlet, emergency overflow or bypass structures). Manhole and catch basin lids must be in or at the edge of the access road.
3. A graded 16-foot wide access ramp into the basin shall be constructed near the basin outlet. An access ramp is required for removal of sediment with a backhoe or loader and truck. The ramp must extend to the basin bottom to avoid damage to vegetation planted on the basin slope. A 16-foot wide commercial driveway approach shall be provided where curb and gutter front the maintenance ramp.
4. All access ramps and roads shall be provided in accordance with the current policies of the Flood Control District.

**6.10.3.4      Construction Considerations**

The use of treated wood or galvanized metal anywhere inside the facility is prohibited. The use of galvanized fencing is permitted by the Flood Control District.

Figure 6-28: Dry Extended Detention Basin Schematic

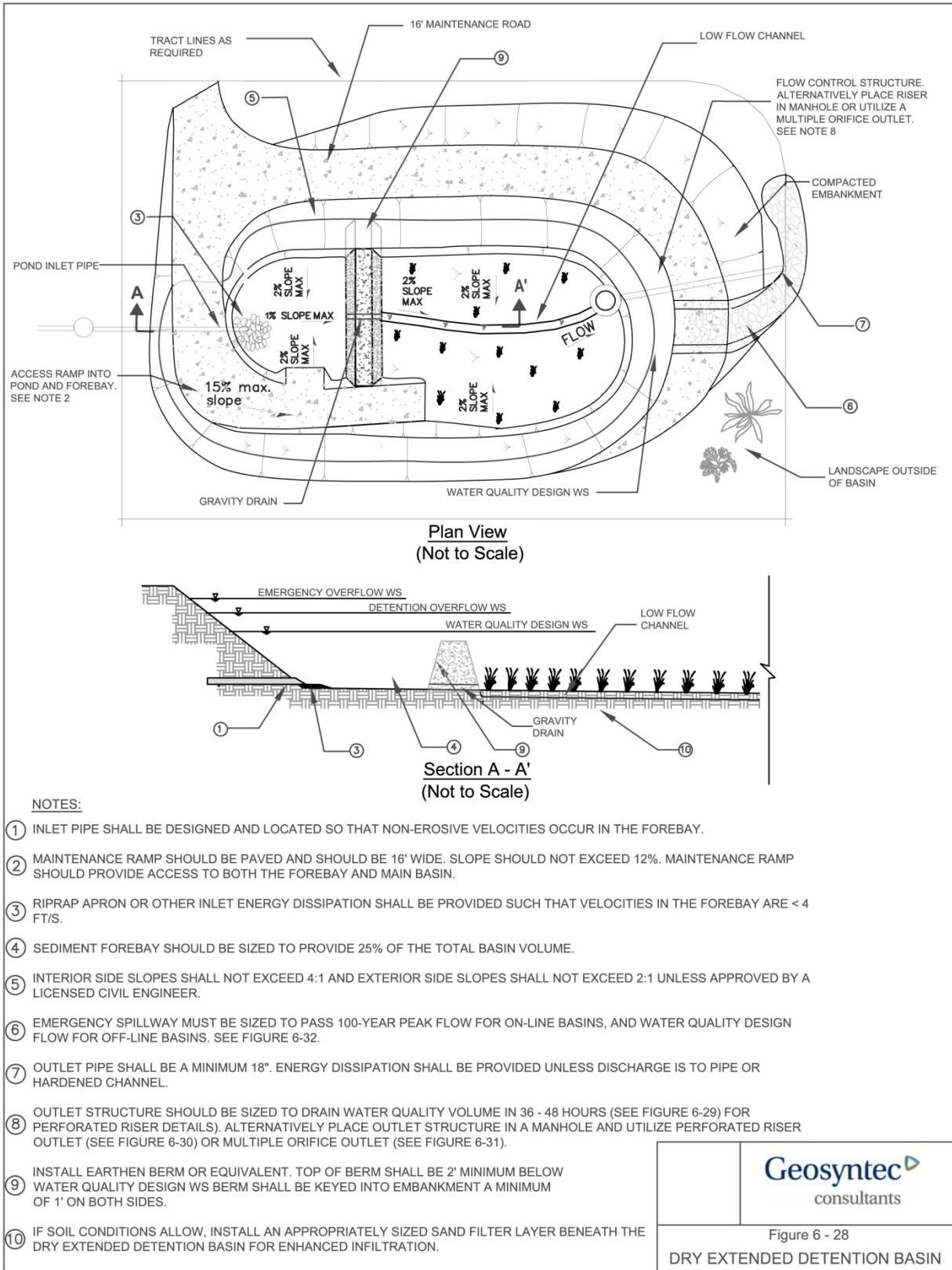

Geosyntec  
consultants

Figure 6 - 28  
DRY EXTENDED DETENTION BASIN

Figure 6-29: Perforated Riser Outlet Schematic – Option 1

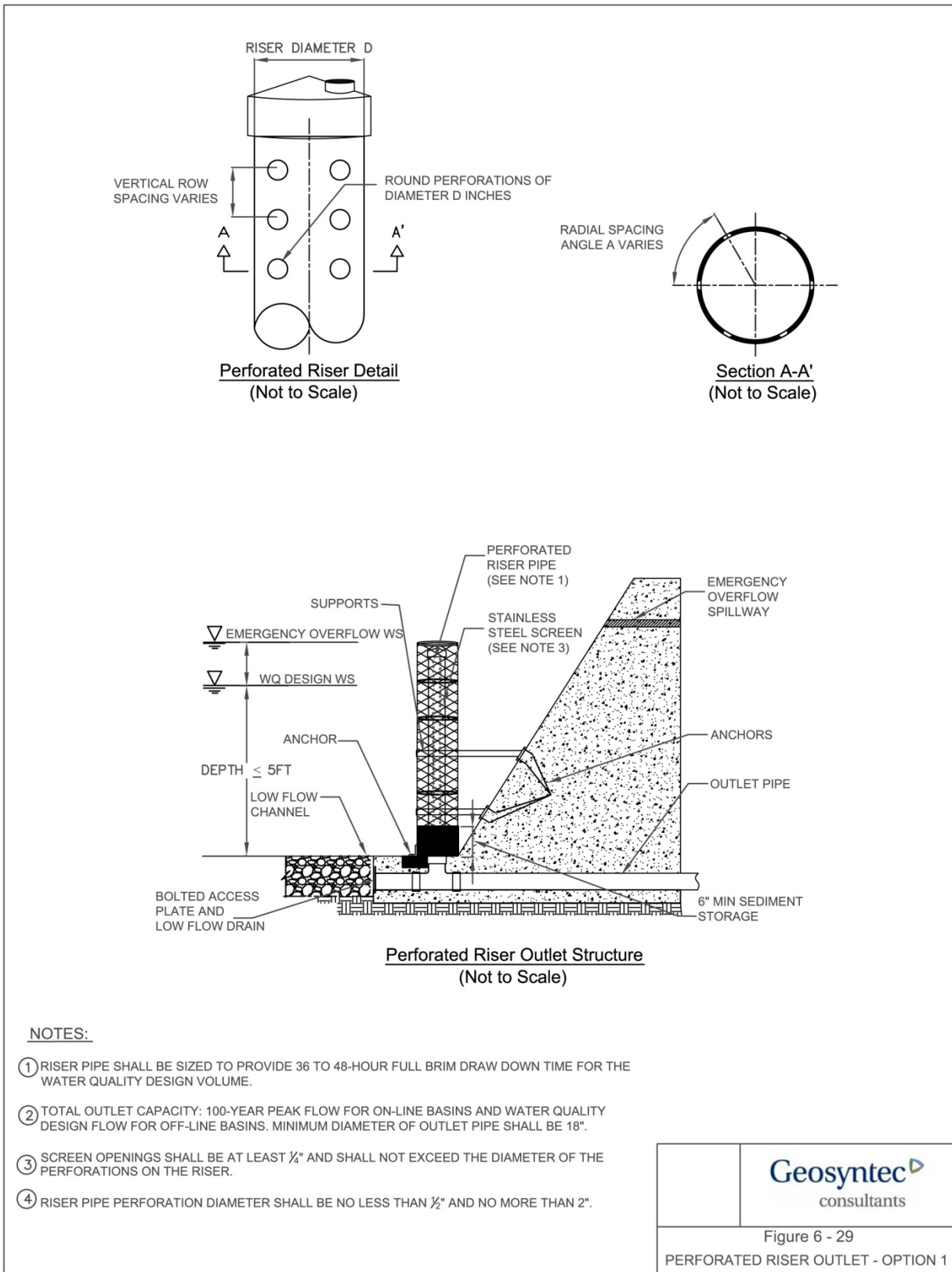



Figure 6-30: Perforated Riser Outlet Schematic – Option 2

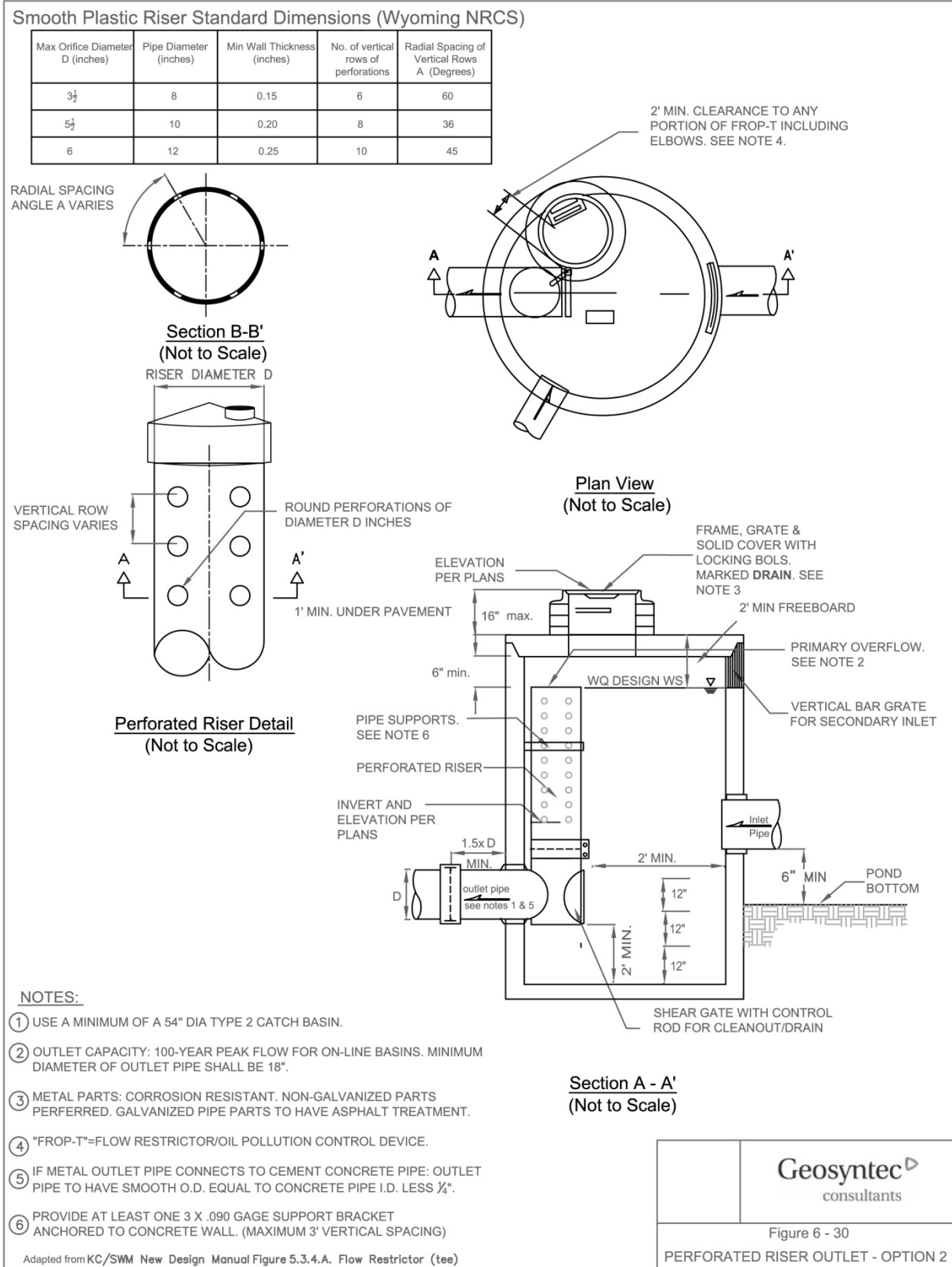

Figure 6-31: Multiple Orifice Outlet Schematic – Option 3

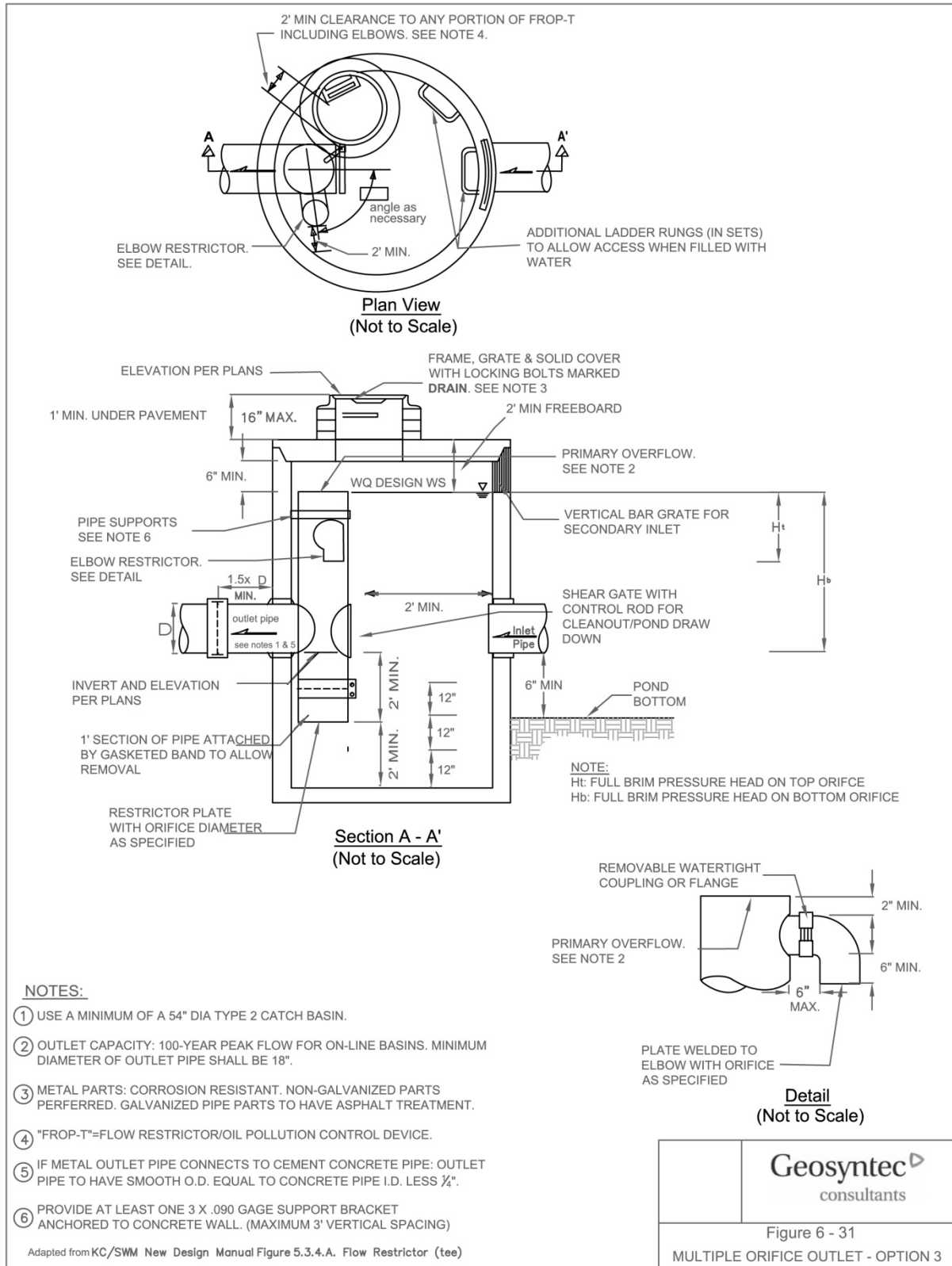
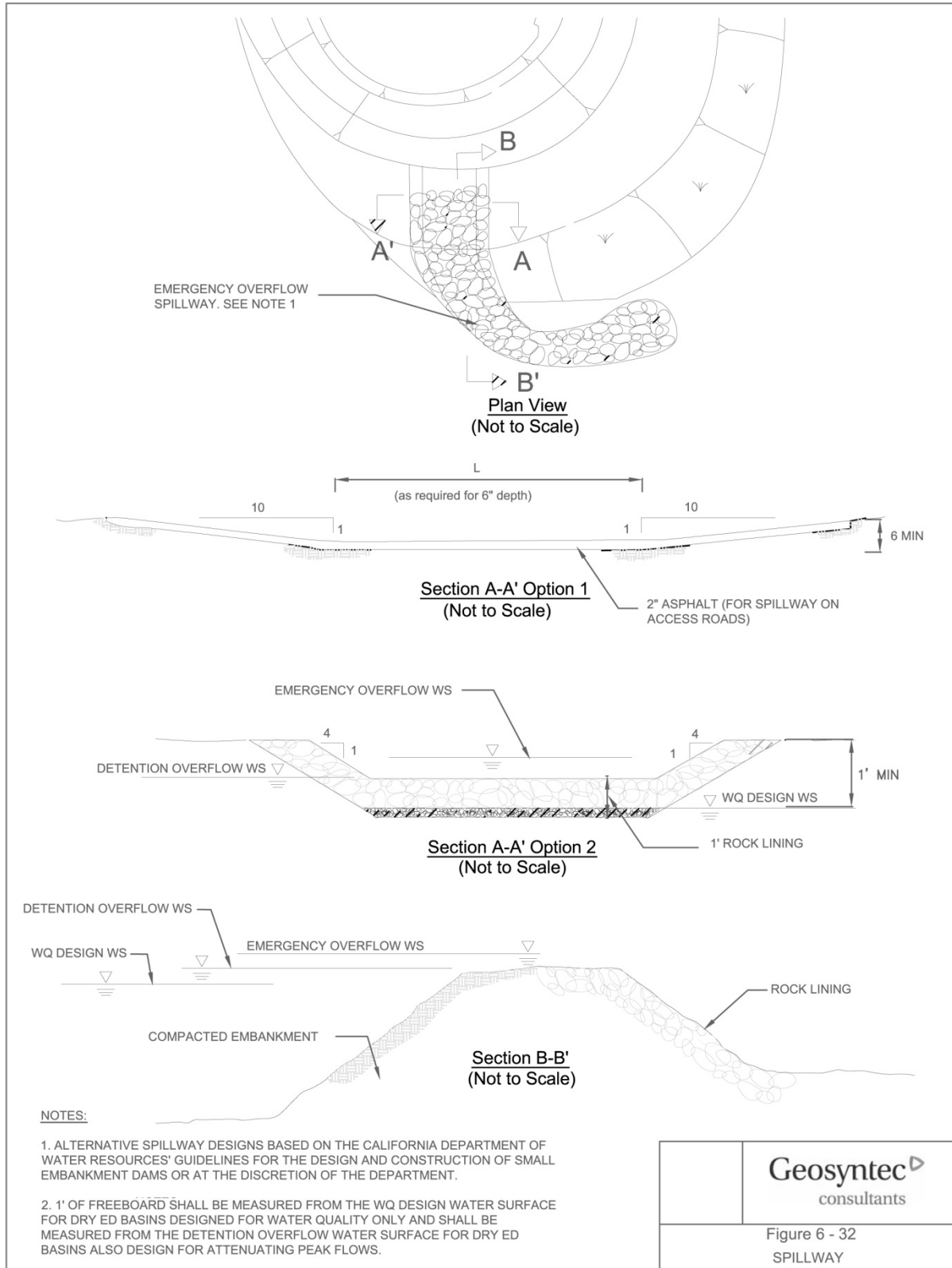

Figure 6-32: Emergency Spillway Schematic



|   |  |
|---|--|
| <p><b>Geosyntec</b><br/>consultants</p> |  |
| <p>Figure 6 - 32<br/>SPILLWAY</p>       |  |

### 6.10.3.5 Operations and Maintenance

#### *General Requirements*

Maintenance is of primary importance if extended detention basins are to continue to function as originally designed. A maintenance agreement must be developed with the Flood Control District to ensure adequate performance and allow the County emergency access. Maintenance of the basin is the responsibility of the development, unless otherwise agreed upon.

A specific maintenance plan shall be formulated for each facility outlining the schedule and scope of maintenance operations, as well as the data handling and reporting requirements. The following are general maintenance requirements:

1. The basin shall be inspected annually and inspections after major storm events are encouraged. Trash and debris shall be removed as needed, but at least annually prior to the beginning of the wet season (see Appendix H for dry extended detention basin inspection and maintenance checklist).
2. Site vegetation shall be maintained as follows:
3. Vegetation, large shrubs, or trees that limit access or interfere with basin operation shall be pruned or removed.
4. Slope areas that have become bare shall be revegetated and eroded areas shall be regraded prior to being revegetated.
5. Grass shall be mowed to 4"-9" high and grass clippings shall be removed.
6. Fallen leaves and debris from deciduous plant foliage shall be raked and removed.
7. Invasive vegetation, such as Alligatorweed (*Alternanthera philoxeroides*), Halogeton (*Halogeton glomeratus*), Spotted Knapweed (*Centaurea maculosa*), Giant Reed (*Arundo donax*), Castor Bean (*Ricinus communis*), Perennial Pepperweed (*Lepidium latifolium*), and Yellow Starthistle (*Centaurea solstitialis*) must be removed and replaced with non-invasive species. Invasive species shall never contribute more than 25% of the vegetated area. For more information on invasive weeds, including biology and control of listed weeds, look at the encyclopedias located at the California Department of Food and Agriculture website- [http://www.cdfa.ca.gov/phpps/ipc/encyclopedias/encyclopedias\\_hp.htm](http://www.cdfa.ca.gov/phpps/ipc/encyclopedias/encyclopedias_hp.htm) or the California Invasive Plant Council website at [www.cal-ipc.org](http://www.cal-ipc.org).
8. Dead vegetation shall be removed if it exceeds 10% of area coverage. Vegetation shall be replaced immediately to maintain cover density and control erosion where soils are exposed.
9. No herbicides or other chemicals shall be used to control vegetation.
10. Sediment buildup exceeding 50% of the forebay capacity shall be removed. Sediment from the remainder of the basin shall be removed when 6 inches of sediment accumulates. Sediments shall be tested for toxic substance accumulation in compliance with current

disposal requirements if land uses in the catchment include commercial or industrial zones, or if visual or olfactory indications of pollution are noticed. If toxic substances are encountered at concentrations exceeding thresholds of Title 22, Section 66261 of the California Code of Regulations, the sediment must be disposed of in a hazardous waste landfill.

11. Following sediment removal activities, replanting, and/or reseeding of vegetation may be required for reestablishment.

### ***Maintenance Standards***

A summary of the routine and major maintenance activities recommended for dry extended detention ponds is shown in Table 6-76. The routine and major maintenance standards listed in Table 6-77 and Table 6-78 are intended to be measures to determine if maintenance actions are required as identified through inspection. They are not intended to be measures of the facility's required condition at all times between inspections. In other words, exceedance of these thresholds or measures at any time between inspections and/or scheduled maintenance does not constitute a violation of these standards. These standards are violated only when an inspection identifies required maintenance action that has not been scheduled before the next regular inspection.

Table 6-76: Dry Extended Detention Basin Maintenance Quick Guide

| <b>Inspection and Maintenance Activities Summary</b> |   |
|--|---|
| <b>Routine Maintenance</b>                           | <ul style="list-style-type: none"> <li>• Trash and debris removal</li> <li>• Remove any evidence of visual contamination from floatables such as oil and grease</li> <li>• Remove minor sediment accumulation near inlet and outlet structures</li> <li>• Stabilize/repair eroded banks and fill in animal burrows if present</li> <li>• Minor structural repairs to inlet/outlet structures, valves, sluice gates, pumps, fences, locks, access hatches shall be inspected and kept functional</li> <li>• Eliminate pests and conditions that promote breeding of pests</li> <li>• Periodically observe function under wet weather conditions</li> <li>• Photographs taken before and after maintenance is encouraged</li> </ul>   |
| <b>Major Maintenance</b>                             | <ul style="list-style-type: none"> <li>• Remove dead, diseased, or dying trees and woody vegetation that interfere with facility maintenance</li> <li>• Clean-out underdrains</li> <li>• Correct problems associated with berm settlement</li> <li>• Repair berm/dike breaches and stabilize eroded parts of the berm</li> <li>• Repair and rebuild spillway as needed to reverse the effects of severe erosion</li> <li>• Remove sediment build up in forebay and main basin area to restore original sediment holding capacity</li> <li>• Regrade main basin bottom to restore bottom slope and eliminate the incidence of standing pools</li> <li>• Aerate compacted areas to promote infiltration if volume reductions are desired</li> <li>• Repair or replace gates, fences, flow control structures, and inlet/outlet structures as needed to maintain full functionality</li> </ul> |

Table 6-77: Routine Maintenance Standards - Extended Detention Basins

| Defect                               | Conditions When Maintenance Is Needed   | Results Expected When Maintenance Is Performed   | Frequency  |
|--------------------------------------|---|--|--|
| Trash & Debris                       | Any trash and debris which exceed 5 cubic feet per 1,000 sf of basin area (one standard garbage can). In general, there shall be no visual evidence of dumping.<br><br>If less than threshold all trash and debris will be removed as part of next scheduled maintenance. | Trash and debris cleared from site.  | Annually prior to wet season<br><br>After major storm events (>0.75 in/24 hrs) if spot checks of some basins indicate widespread damage/ maintenance needs |
| Inlet / outlet sediment accumulation | Minor sediment accumulation that affects flow through the facility.   | Sediment cleaned out.  |  |
| Erosion of banks and channels        | Rilling over 2 inches deep where cause of damage is still present or where there is potential for continued erosion.<br><br>Any erosion observed on a compacted berm embankment.  | Slopes shall be stabilized using appropriate erosion control measure(s); e.g., rock reinforcement, planting of grass, compaction.  |  |
| Visual contaminants and pollution    | Any evidence of oil, gasoline, contaminants or other pollutants.  | No visual evidence of contaminants or pollutants present.  |  |
| Noxious pests                        | Visual observations or receipt of complaints of numbers of pests that would not be naturally occurring and could pose a threat to human or aquatic health.  | Vectors controlled per Mosquito and Vector Management District of Santa Barbara County standards. A Mosquito Management Plan or Service Contract must be presented to the Vector Management District for any facility that maintains a pool of water for 72 hours or more. |  |
| Aesthetics                           | Minor vegetation removal and thinning. Mowing berms and surroundings  | Facility is well kept and able to handle dry-weather flows without causing a nuisance (visual eye sore, stagnate water, etc.)  |  |
|                                      |   |  |  |

| Defect        | Conditions When Maintenance Is Needed | Results Expected When Maintenance Is Performed  | Frequency   |
|---------------|---------------------------------------|---|-------------|
| Noxious Weeds | Any evidence of noxious weeds.        | Eradicate all noxious weeds; control and prevent the spread of all noxious weeds. Use Integrated Pest Management techniques, if applicable. See <a href="http://www.ipm.ucdavis.edu/">http://www.ipm.ucdavis.edu/</a> for more information on pest and weed management. | contractor) |

Table 6-78: Major Maintenance Standards - Extended Detention Basins

| Defect              | Conditions When Maintenance Is Needed  | Results Expected When Maintenance Is Performed  | Frequency  |
|---------------------|--|---|--|
| Tree Growth         | Tree growth does not allow maintenance access or interferes with maintenance activity (i.e., slope mowing, silt removal, vactoring, or equipment movements). If trees are not interfering, do not remove. Dead, diseased, or dying trees shall be removed. | Trees do not hinder maintenance activities. Remove dead, diseased, or dying trees. (Use a certified Arborist to determine health of tree or removal requirements) | Annual or as needed (infrequent)<br>After major storm events (>0.75 in/24 hrs) if spot checks of some basins indicate widespread damage/maintenance needs. |
| Settling of berm    | If settlement is apparent. Settling can be an indication of more severe problems with the berm or outlet works. A civil engineer shall be consulted to determine the source of the settlement if the dike/berm is serving as a dam.                        | Dike is built back to the design elevation.   |  |
| Piping through berm | Discernable water flow through basin berm. Ongoing erosion with potential for erosion to continue. A licensed civil engineer shall be called in to inspect and evaluate condition and recommend repair of condition.                                       | Piping eliminated. Erosion potential resolved and berm stability achieved. Report of annual burrows.  |  |



| Defect   | Conditions When Maintenance Is Needed   | Results Expected When Maintenance Is Performed  | Frequency |
|--|---|---|-----------|
| Tree and large shrub growth on downstream slope of embankments | Tree and large shrub growth on downstream slopes of embankments may prevent inspection and provide habitat for burrowing rodents. | Trees and large shrubs shall be removed. All dead roots shall be removed if practical. Otherwise, dead roots shall be removed to a minimum of 36 inches below grade and replaced with cement grout to 12 inches below grade. The top 12 inches of the root holes shall be filled with compacted, in-situ soils. The area facility engineer may require additional root removal if necessary for dam safety or maintenance purposes. |           |
| Erosion on Spillway  | Rock is missing and soil is exposed at top of spillway or outside slope.  | Rocks and pad depth are restored to design standards.   |           |
| Sediment accumulation  | Sediment buildup exceeding 50% of the forebay capacity. Six inches or more of accumulated sediment across basin bottom.           | Basin capacity restored.  |           |
| Standing water   | Low flow channel is not draining, standing pools of water are observed.   | No standing pools of water in low flow channel.   |           |
| Gate/Fence Damage  | Damage to gate/fence, including missing locks and hinges  | Gate/Fence repaired.  |           |

## 6.11 Proprietary Devices



**Figure 6-33: Filterra Tree Box Filter**

*Photo Credit: Filterra Bioretention Systems*

### 6.11.1 Description

Proprietary devices are commercial products that typically aim to provide storm water treatment in space-limited applications, often using patented innovative technologies. The most commonly encountered classes of proprietary storm water management controls include hydrodynamic separation, catch basin insert technologies, cartridge filters, and proprietary biotreatment devices.

Hydrodynamic separation devices (alternatively, swirl concentrators) are devices that remove trash, debris, and coarse sediment from incoming flows using screening, gravity settling, and centrifugal forces generated by forcing the influent into a circular motion. By having the water move in a circular fashion, rather than a straight line, it is possible to obtain significant removal of suspended sediments and attached pollutants with less space as compared to wet vaults and other settling devices. Hydrodynamic devices were originally developed for combined sewer overflows (CSOs), where they were used primarily to remove coarse inorganic solids. Hydrodynamic separation has been adapted for storm water treatment by several manufacturers and is currently used to remove trash, debris, and other coarse solids down to sand-sized particles. Several types of hydrodynamic separation devices are also designed to remove floating oils and grease using sorbent media. For more information on specific hydrodynamic devices and their vendors refer to Table 6-79.

Catch basin inserts are manufactured filters or fabric placed in a drop inlet to remove sediment and debris and may include sorbent media to remove floating oils and grease. There are a multitude of inserts of various shapes and configurations, typically falling into one of three groups: socks, boxes, and trays. The sock-type filters are typically constructed of a fabric, usually polypropylene. The fabric may be attached to a frame or the grate of the inlet may hold

### Applications

- Roads, highways, parking lots
- Commercial and mixed use
- Industrial
- Residential

### Advantages

- Can be selected to target specific contaminants
- Often smaller footprint required

### Limitations

- Must be purchased from private sector firm
- May require more maintenance
- Performance must be verified by third party

the sock. Socks are meant for vertical (drop) inlets. Boxes are constructed of plastic or wire mesh. Typically a polypropylene “bag” is placed in the wire mesh box and the bag takes the form of the box. Most box products are one box; that is, settling and filtration through media occur in the same box. Other products consist of one or more trays or mesh grates. The trays may hold different types of media. Filtration media vary by manufacturer. Types include polypropylene, porous polymer, treated cellulose, and activated carbon. Inserts are an easy and inexpensive retrofitting option because drain inlets are already a component of most standard drainage systems. Inserts are usually only suitable for mitigating relatively small tributary areas (less than 1 acre); however, depending on the size of the project, this structure normally does not meet BMP requirements for water quality treatment but does assist with pretreatment. For more information on specific catch basin inserts and their vendors refer to Table 6-79.

Cartridge filters typically consist of a series of vertical filters contained in a vault or catch basin that provide treatment through filtration and sedimentation. The vault may be divided into multiple chambers where the first chamber acts as a pre-settling basin for removal of coarse sediment while another chamber acts as the filter bay and houses the filter cartridges. The performance and capacity of a cartridge filter installation depends on the properties of the media contained in the cartridges. Cartridge filter manufacturers often provide an array of media types each with varying properties, targeting various pollutants and a range of particle sizes. Commonly used media include media that target solids, such as perlite, and media that target both dissolved and non-dissolved constituents, such as compost leaf media, zeolite, and iron-infused polymers. Manufacturers try to distinguish their products through innovative cartridge designs that aim at providing self cleaning and draining, uniform loading, and clog resistance allowing the devices to function properly over a wide range of hydraulic loadings and pollutant concentrations. For more information on specific cartridge filter models and their vendors refer to Table 6-79.

Proprietary biotreatment devices are devices that are manufactured to mimic natural systems such as bioretention areas by incorporating plants, soil, and microbes engineered to provide treatment at higher flow rates or volumes and with smaller footprints than their natural counterparts. Incoming flows are typically filtered through a planting media (mulch, compost, soil, plants, microbes, etc) and either infiltrated or collected by an underdrain and delivered to the storm water conveyance system. Tree box filters are an increasingly common type of proprietary biotreatment device that are installed at curb level and filled with a bioretention type soil. For low to moderate flows they operate similarly to bioretention systems and are bypassed during high flows. Tree box filters are highly adaptable solutions that can be used in all types of development and in all types of soils but are especially applicable to dense urban parking lots, street, and roadways. Tributary areas for biotreatment devices tend to be limited to 0.25 to 1.0 acres. For more information on specific biotreatment devices and their vendors refer to Table 6-79.

The vendors of the various proprietary BMPs provide detailed documentation for device selection, sizing, and maintenance requirements. Tributary area sizes are limited to the capacities of the largest available model. The latest manufacturer supplied documentation must be used for sizing and selection of all proprietary devices. Links to the websites of a number of vendors of proprietary devices are included in Table 6-79.

### ***6.11.2 Performance, Applicability, and Limitations***

The treatment effectiveness of specific proprietary devices must be provided by the manufacturer and shall be verified by independent third-party sources and data or assessed by a water quality professional. The Santa Barbara County Flood Control District requires that proprietary devices used in the County be accompanied by a certification from a licensed civil engineer that the device will maintain an effluent quality of 10-30 mg/L of total suspended solids with no visible oily sheen under design operating conditions. The following provides general performance guidance for the different proprietary devices.

#### Hydrodynamic Devices

Hydrodynamic separation devices are effective for removal of coarse sediment, trash, and debris, and are useful as pretreatment in combination with other BMP types that target smaller particle sizes. Hydrodynamic devices represent a wide range of device types that have different unit processes and design elements (e.g., storage versus flow-through designs, inclusion of media filtration, etc.) that vary significantly within the category. These design features likely have significant effects on BMP performance; therefore, generalized performance data for hydrodynamic devices is not practical.

#### Catch Basin Inserts

Catch basin inserts come in such a wide range of configurations that it is practically impossible to generalize the expected performance. Inserts shall mainly be used for catching coarse sediments and floatable trash, and are effective as pretreatment in combination with other types of structures that are recognized as water quality treatment BMPs. Trash and large objects can greatly reduce the effectiveness of catch basin inserts with respect to sediment and hydrocarbon capture. Frequent maintenance and the use of screens and grates to keep trash out may decrease the likelihood of clogging and prevent obstruction and bypass of incoming flows.

#### Cartridge Filters

Cartridge filters have been proven to provide efficient removals of both dissolved and non-dissolved constituents. Cartridge filters are, however, less adept at handling high flow rates as compared to catch basin inserts and hydrodynamic devices, mainly due to the enhanced treatment provided through the filtration mechanism.

#### Biotreatment Devices

Proprietary biotreatment devices are relatively new compared to the other types of proprietary treatment devices included in this document. Therefore, there are fewer third party studies on proprietary biotreatment devices and the available performance information is mostly vendor-supplied. Tree box filters remove pollutants through the same processes as bioretention and reduce runoff volume and peak discharge rate for small frequently occurring storms and are not intended to capture and or detain large volumes. According to the vendors, like their natural counterparts, proprietary biotreatment devices are highly efficient at mitigating dissolved metals, nutrients, and suspended solids.

More detailed performance information is available from the vendors of each class of proprietary device. The performance numbers are typically presented as percent removals rather than effluent quality measurements and can be found on the vendor websites using the links provide in Table 6-79.

### ***6.11.3 Design Criteria and Procedure***

Proprietary BMP vendors are constantly updating and expanding their product lines, so refer to the latest design guidance from each of the vendors. General guidelines on the performance, sizing, operations and maintenance of proprietary devices are provided below.

The City of Santa Barbara does not keep a list of "approved" proprietary BMPs; however, in general, any proprietary device BMP must meet the following minimum standards:

1. The device shall be accompanied by a certification from a licensed civil engineer that the device will maintain effluent quality of 10-30 mg/L of total suspended solids with no visible oily sheen under design operating conditions;
2. It must not adversely affect the level of flood protection provided by the drainage system - head loss must be verifiable by the County Flood Control District;
3. It shall be selected to have high or very high treatment effectiveness for the primary pollutants of concern (as identified in Section 6.3).
4. It shall be vector-resistant, or not pond water for more than 72 hours after the end of a storm;
5. It shall not worsen water quality by resuspending trash, sediments, or bacteria (through regrowth), or by leaching heavy metals or semi-volatile organic compounds during subsequent storms;
6. If it is to be an underground device with access shafts, it must: (a) meet or exceed American Public Works Association (APWA) standards, (b) be reasonably accessible by a qualified maintenance worker, (c) have ladder rungs, have the ability to withstand lateral soil pressures, (d) have provisions for confined space entry, and (e) have safety guard rails around the rim;
7. It shall have no plastic or fiberglass interior parts that would break or shatter in the path of direct flow;
8. Its pipes, conduits and vaults shall not be more than 20 feet below ground and be easily accessible by a vacuum truck hose for clean-out; and
9. It shall provide means to block off the inflow and tail water backflow to isolate the device for safe maintenance and repair of the unit.

### *Sizing*

Hydrodynamic devices, catch basin inserts, and cartridge filters are flow-based BMPs and therefore, shall be sized to capture and treat the water quality design flow rate if used as a standalone BMP. Proprietary biotreatment devices, on the other hand include, both volume-based and flow-based BMPs. Volume-based proprietary devices shall be sized to capture and treat the water quality design volume if used as a standalone BMP.

Auxiliary components of proprietary devices such as sorbent media, screens, baffles, and sumps are selected based on site specific conditions such as the loading that is expected and the desired frequency of maintenance. Sizing of proprietary devices is reduced to a simple process whereby a model can simply be selected from a table or a chart based on a few known quantities (tributary area, location, design flow rate, design volume, etc). A few of the manufacturers either size the devices for potential clients or offer calculators on their websites that simplify the design process even further and lessens the possibility of using obsolete design information. For the latest sizing guidelines, refer to the manufacturer's website.

#### **6.11.4 Operation and Maintenance**

##### Hydrodynamic Separation Devices

Hydrodynamic separators do not have any moving parts and are consequently not maintenance intensive. Maintenance is important, however, to ensure that they are operating as efficiently as possible. Proper maintenance involves frequent inspections throughout the first year of installation, especially after major storm events. The systems are considered full when the sediment level is within one foot of the unit's top, at which point it must be cleaned out. Removal of sediment can be performed with a sump vac or vacuum truck. Some hydrodynamic separator systems may contribute to mosquito breeding if they hold standing water between storms for longer than 72 hours. Refer to the manufacturer's guidelines for inspection and maintenance activities.

##### Catch Basin Inserts

Catch basin inserts can be maintenance intensive due to their susceptibility for accumulating trash and debris. Regular maintenance activities include cleanup and removal of accumulated trash and sediment, while major maintenance activities include replacing filter media (if used) and/or repairing/replacing geotextile fabrics. There are a number of proprietary catch basin inserts and proper maintenance procedures that shall be determined based on manufacturer's recommendations for the selected catchbasin insert.

##### Cartridge filters

Maintenance activities include periodically removing captured trash, debris, and sediment from the vault floor, typically twice per year depending on the accumulation rate using a sump vac or vacuum truck. The media in media filters has to be replaced when it becomes saturated; typically about once every other year depending on the pollutant accumulation rate. The manufacturers of these devices typically provide contract operations and maintenance services.

All storm water vaults containing cartridge filters that have standing water for longer than 72 hours can become a breeding area for mosquitoes. Manufacturers have developed systems to completely drain the vault, such as a perforated pipe installed in the bottom of the vault that is encased in a filter sock to prevent clogging.

#### Biotreatment Devices

Maintenance of biotreatment devices can be provided by the manufacturers and typically consists of routine inspection and hand removal of accumulated trash and debris. As opposed to other proprietary treatment devices, no vacuum trucks or mechanical maintenance is needed.

#### ***Online Resources***

Table 6-79 provides a list of links to the websites of several proprietary storm water management controls manufacturers current as of April 2008. The products listed in Table 6-79 are proprietary and nonproprietary products that are meant to improve or eliminate pollution associated with urban runoff and storm water. The phrase "Best Management Practice" is a common term used in Federal, State, and local regulations to label these types of products, activities, and services. Usage of the term does not imply that some products, activities, or services are better than others, or that the City of Santa Barbara evaluates or decides which product, activity, or service shall be listed. The inclusion of vendors, manufacturers, and products on this list in no way represents an endorsement or guarantee of effectiveness as a result of the use of these products, nor for any compliance issues regarding the Americans with Disabilities Act. Please contact the vendor and follow the manufacturers' specifications for proper preparation, installation, and maintenance of these products.

Table 6-79: Proprietary Device Manufacturer Websites

| Category            | Device                                       | Manufacturer                         | Website  |
|---------------------|--|--------------------------------------|--|
| Hydrodynamic Device | BayFilter                                    | BaySaver Inc.                        | <a href="http://www.baysaver.com">www.baysaver.com</a>   |
|                     | V2B1™ Stormwater Treatment System            | Environment 21, LLC                  | <a href="http://www.env21.com">www.env21.com</a>   |
|                     | Aqua-Swirl™ Concentrator                     | Aquashield, Inc.                     | <a href="http://www.aquashieldinc.com">www.aquashieldinc.com</a>   |
|                     | Vortechs™, CDS™, VortSentry™, VortSentry™ HS | Contech Stormwater Solutions         | <a href="http://www.contech-cpi.com/stormwater/products/14">www.contech-cpi.com/stormwater/products/14</a>                                   |
|                     | Downstream Defender™                         | H.I.L. Technology, Inc.              | <a href="http://www.hydro-international.biz/us/stormwater_us/downstream.php">www.hydro-international.biz/us/stormwater_us/downstream.php</a> |
|                     | Continuous Deflection Separation(CDS) Unit,  | CDS Technologies, Inc.               | <a href="http://www.CDStech.com">www.CDStech.com</a>   |
|                     | CrystalStream                                | CrystalStream Technologies           | <a href="http://www.crystalstream.com">www.crystalstream.com</a>   |
| Catch Basin Insert  | Curb Inlet Basket, Grate Inlet Skimmer       | Suntree Technologies Inc.            | <a href="http://www.suntreetech.com">www.suntreetech.com</a>   |
|                     | Ultra-CurbGuard, Hydro-Kleen                 | UltraTech International, Inc.        | <a href="http://www.spillcontainment.com/stormwater">www.spillcontainment.com/stormwater</a>   |
|                     | The Hydro-Cartridge®                         | Advanced Aquatic International, Inc. | <a href="http://www.hydro-cartridge.com">www.hydro-cartridge.com</a>   |
|                     | Streamguard™ Catch Basin Insert              | Bowhead Manufacturing Co.            | <a href="http://www.b-bmarketingcorp.com/streamguard.htm">www.b-bmarketingcorp.com/streamguard.htm</a>                                       |
|                     | Aqua-Guard™ Catch Basin Insert               | Aquashield, Inc.                     | <a href="http://www.aquashieldinc.com">www.aquashieldinc.com</a>   |
|                     | Ultra-Urban Filter                           | AbTech Industries                    | <a href="http://www.abtechindustries.com">www.abtechindustries.com</a>   |
|                     | FloGard+Plus,                                | KriStar Enterprises, Inc.            | <a href="http://www.kristar.com">www.kristar.com</a>   |



| Category                 | Device             | Manufacturer                 | Website  |
|--------------------------|--------------------|------------------------------|--|
|                          | Triton™            | Contech Stormwater Solutions | <a href="http://www.contech-cpi.com/stormwater/products/14">www.contech-cpi.com/stormwater/products/14</a> |
| Cartridge Filter         | MFS™ StormFilter™  | Contech Stormwater Solutions | <a href="http://www.contech-cpi.com/stormwater/products/14">www.contech-cpi.com/stormwater/products/14</a> |
| Proprietary Biotreatment | Filterra           | Americast                    | <a href="http://www.filterra.com">www.filterra.com</a>   |
|                          | StormTreat Systems | StormTreat Systems Inc       | <a href="http://www.stormtreat.com/home.htm">www.stormtreat.com/home.htm</a>                               |

**Note:** Web links last accessed in April 2008.

## 7 REFERENCES

- California Environmental Protection Agency. (2001, April). *The History of the California Environmental Protection Agency*. Retrieved March 4, 2008, from California Environmental Protection Agency: <http://www.calepa.ca.gov/About/History01/swrcb.htm>
- California Environmental Protection Agency: State Water Resources Control Board. (2006, August 03). Retrieved March 05, 08, from Storm Water Program: Municipal Program: <http://www.swrcb.ca.gov/stormwtr/municipal.html>
- City of Portland Environmental Services. *How to Manage Stormwater: Downspout Disconnection*. Portland, OR.
- City of Portland Environmental Services. *How to Manage Stormwater: Rain Barrels*. Portland, OR.
- City of Portland Environmental Services. *How to Manage Stormwater: Rain Gardens*. Portland, OR.
- City of Santa Barbara. (2007). *City of Santa Barbara National Pollutant Discharge Elimination System (NPDES) Storm Water Mangement Program*.
- Contra Costa Clean Water Program. (2006). *Stormwater C.3 Guidebook*.
- County of San Diego Department of Planning and Land Use. (2007). *Low Impact Development Handbook: Stormwater Mangement Strategies*. San Diego.
- Georgia Stormwater Management Manual. (2001). Volume 2: Technical Handbook. Atlanta Regional Commission. Atlanta, GA, USA.
- Hsieh, C. and A. Davis. (2005). Evaluation and Optimization of Bioretention Media for Treatment of Urban Storm Water Runoff. *J. Environ. Eng. ASCE*. 131(11). 1521-1531.
- Hunt W., A. Jarrett, J. Smith, and L. Sharkey. (2006). Evaluating Bioretention Hydrology and Nutrient Removal at Three Field Sites in North Carolina. *Journal of Irrigation and Drainage Engineering*. 132(6) 600-608.
- Hunt, W. and W. Lord. (2006). *Bioretention Performance, Design, Construction, and Maintenance*. Published by: North Carolina Cooperative Extension Service. AGW-588-05.
- Hunt, W. and B. Doll. (2000). *Designing Stormwater Wetlands for Urban Watersheds*. Urban Waterways Publication Series. North Carolina Cooperative Extension Service.
- Hunt, W. and L. Szpir. (2006). *Permeable Pavements, Green Roofs, and Cisterns*. Urban Waterways Publication Series. North Carolina Cooperative Extension Service.

- Kim, H., E. Seagren, and A. Davis. (2003). Engineered Bioretention for Removal of Nitrate from Stormwater Runoff. *Water Environ. Res.* 75(4). 355-367.
- King County Surface Water Design Manual, 2005. King County, Washington Department of Natural Resources and Parks. January 24, 2005.
- King County Surface Water Design Manual Appendix A: "Maintenance requirements for flow control, conveyance, and water quality facilities. (2005). King County, WA, USA.
- Low Impact Development Center. "Low Impact Development Training for Western Developers: Supplemental Materials." August 2006.
- Low Impact Development Manual. (1993). London Ecology Unit.
- Maintaining Your BMP. (2000). Northern Virginia Planning District Commission, Division of Environmental Services. Virginia, USA.
- Maintenance Inspection Checklists, Notifications and Reminders (2005). Taken from: [www.stormwatercenter.net](http://www.stormwatercenter.net) Manual Builder Guidelines.
- Metropolitan Council. *Urban Small Sites Best Management Practice Manual*. St. Paul: Metropolitan Council Environmental Services, 2001.
- NASA. *Goddard Space Flight Center*. <http://soil.gsfc.nasa.gov/tbf/txtbyfel.htm> (accessed May 04, 2008).
- Natural Resource Conservation Service (NRCS). "Field Indicators of Hydric Soils in the United States: Guide for Identifying and Delineating Hydric Soils. Version 5.01."
- Pennsylvania Department of Environmental Protection. *Pennsylvania Stormwater Best Management Practices Manual*. 2006.
- Prince George's County, Maryland Department of Environmental Resources Programs and Planning Division. "Low-Impact Development Design Strategies." 1999.
- Questa Engineering Corp. "City of Santa Barbara Creek Development Standards - Draft Report." 2003.
- Santa Barbara County Flood Control and Water Conservation District. (2007). Standard Conditions for Project Approval. Santa Barbara, CA, USA.
- Santa Barbara County Flood Control and Water Conservation District. (2006). Standard Conditions for Project Plan Approval – Water Quality BMPs.
- Santa Barbara County Water Agency and the City of Santa Barbara . "Preventing Pollution in our Creeks and Ocean: A Guide for Construction Contractors." *Project Clean Water*. 2001.

Santa Clara Valley Urban Runoff Pollution Prevention Program (SCVURPP) Fact Sheets (2003). SCVURPP C.3 Guidance Manual, California, USA.

State Water Resources Control Board (2006). *California Nonpoint Source Encyclopedia*. Prepared by Tetra Tech, Inc. [Online]  
<http://www.swrcb.ca.gov/nps/docs/encyclopedia/encyclopedia.pdf>

Stormwater Best Management Practice Handbook: New development and redevelopment. (2003). California Stormwater Quality Association. Menlo Park, CA, USA.

Stormwater Management Manual. (2004). City of Portland Bureau of Environmental Services. Portland, Oregon, USA

Strecker, E.; Huber, W.; Heaney, J.; Bodine, D.; Sansalone, J.; Quigley, M.; Leisenring, M.; Pankani, D.; and Thayumanavan, A. (2005). "Critical Assessment of Stormwater Treatment and Control Selection Issues." Final report to the Water Environment Research Foundation. WERF 02-SW-1.

Strecker, E.W., Quigley, M.M., Urbonas, B. and J. Jones. (2004). Analyses of the Expanded EPA/ASCE International BMP Database and Potential Implications for BMP Design, In Proceedings of the World Water and Environmental Resources Congress, Salt Lake City, Utah, American Society of Civil Engineers.

Susilo, K.; Steets, B.; Leisenring, M.; and Strecker, E. (2006). Los Angeles County-Wide Structural BMP Prioritization Methodology. Submitted by Heal the Bay and the County and City of Los Angeles to the Regional Water Quality Control Board, Los Angeles Region. SWRCB Agreement Number: 03-203-554-0.

Technical Guidance Manual for Stormwater Quality Control Measures. (2002). Ventura Countywide Stormwater Quality Management Program. Ventura County, CA, USA.

*Technical Manual for Stormwater Best Management Practices in the County of Los Angeles*. Los Angeles: County of Los Angeles Department of Public Works, 2004.

UDFCD, Urban Drainage and Flood Control District (1999). Urban Storm Drainage Criteria Manual. Denver, CO, USA.

U.S. Environmental Protection Agency. *2000 Water Quality Report to Congress (305(b) report)*. U.S. EPA, 2000.

U.S. EPA. *Reducing Stormwater Costs through Low Impact Development (LID) Strategies and Practices*. EPA, 2007.

U.S. EPA. *Stormwater Phase II Final Rule Fact Sheet 1.0 An Overview*. Washington D.C.: U.S. EPA, 2005.

Ven te Chow. (1964). Handbook of Applied Hydrology. McGraw-Hill, New York.

|            |  |     |
|------------|--|-----|
| Appendix A | Glossary Of Terms.....   | A-1 |
| Appendix B | Site Conditions Maps .....   | B-1 |
| Appendix C | BMP Sizing Methodologies.....  | C-1 |
| Appendix D | BMP Design Examples .....  | D-1 |
| Appendix E | Basin Outlet Sizing Examples.....                                    | E-1 |
| Appendix F | Flow Splitter Design Specifications .....                            | F-1 |
| Appendix G | Local Plant List.....  | G-1 |
| Appendix H | Facility Inspection And Maintenance Checklists .....                 | H-1 |
| Appendix I | Example Agreements, Forms, And Letters .....                         | I-1 |
| Appendix J | List Of Discretionary Projects Exempt From Tier 3 Requirements ..... | J-1 |
| Appendix K | DART SWMP Checklist .....  | K-1 |

## APPENDIX A GLOSSARY OF TERMS

**Best Management Practice (BMP):** Best Management Practices mean those activities, practices, and procedures to prevent, control, reduce, and/or remove the discharge of pollutants directly or indirectly to the storm drain system, surface waters, and/or waters of the State. BMPs include, but are not limited to, treatment practices and facilities to remove pollutants from storm water; operating and maintenance procedures; facility management practices to control site runoff, spillage, or leaks of non-storm water, water disposal, or drainage from raw materials storage; erosion and sediment control practices; and the prohibition of specific activities, practices, and procedures and such other provisions as the City determines appropriate for the control of pollutants.**Bioretention Facility:** A facility that utilizes soil infiltration and both woody and herbaceous plants to remove pollutants from storm water runoff. Runoff is typically captured and infiltrated over a period of 24 to 48 hours.

**Capacity:** The capacity of a storm water drainage facility is the flow volume or rate that the facility (e.g., pipe, basin, vault, swale, ditch, drywell, etc.) is designed to safely contain, receive, convey, reduce pollutants from, or infiltrate storm water to meet a specific performance standard. There are different performance standards for pollution reduction, flow control, conveyance, and destination/ disposal, depending on location.

**Catch Basin:** A structural facility located just below the ground surface, used to collect storm water runoff for conveyance purposes. Generally located in streets and parking lots, catch basins have grated lids, allowing storm water from the surface to pass through for collection. Catch basins also include a sumped bottom and submerged outlet pipe (downturned 90 degree elbow, hood, or baffle board) to trap coarse sediment and oils.

**Check Dam:** Small temporary barrier, grade control structure, or dam constructed across a swale, drainage ditch, or area of concentrated flow with the intent to slow or stop runoff.

**Control Device:** A device used to hold back or direct a calculated amount of storm water to or from a storm water management facility. Typical control structures include vaults or manholes fitted with baffles, weirs, or orifices.

**Conveyance:** The transport of storm water from one point to another.

**Detention Facility:** A facility designed to receive and hold storm water and release it at a slower rate, usually over a number of hours. The full volume of storm water that enters the facility is eventually released.

**Detention Tank, Vault, or Oversized Pipe:** A structural subsurface facility used to provide flow control for a particular drainage basin.

**Drainage Basin:** A specific area that contributes storm water runoff to a particular point of interest, such as a storm water management facility, drainageway, wetland, river, or pipe.

**Embankment:** A long artificial mound of stone or earth; built to hold back water.

**Extended Detention Basin:** A surface vegetated basin used to provide flow control for a particular drainage basin. Storm water temporarily fills the extended detention basin during large storm events and is slowly released over a number of hours, reducing peak flow rates.

**Filter Strip:** A gently sloping, densely grassed area used to filter, slow, and infiltrate storm water.

**Flow Control Facility:** Any structure or drainage device that is designed, constructed, and maintained to collect, retain, infiltrate, or detain surface water runoff during and after a storm event for the purpose of controlling post-development quantity leaving the site.

**Flow Control:** The practice of limiting the release of peak flow rates, flow durations, and volumes from a site. Flow control is intended to protect downstream properties, infrastructure, and natural resources from the increased storm water runoff flow rates and volumes resulting from development.

**Hydrodynamic Separation:** Flow-through structures with a settling or separation unit to remove sediments and other pollutants in which no outside power source is required, because the energy of the flowing water allows the sediments to efficiently separate. Depending on the type of unit, this separation may be by means of swirl action or indirect filtration.

**Impervious Surface / Area:** A hard surface area which either prevents or retards the entry of water into the predevelopment soil mantle. A hard surface area which causes water to run off the surface in greater quantities or at an increased rate of flow from the flow present under predevelopment conditions. Common impervious surfaces include, but are not limited to, roof tops, walkways, patios, driveways, parking lots or storage areas, concrete or asphalt paving, gravel roads, packed earthen materials, and oiled, macadam or other surfaces which similarly impede the natural infiltration of storm water. Open, uncovered retention/detention facilities (i.e., swimming pools, fountains, etc.) are not considered impervious surfaces.

**Infiltration Trench:** A linear excavation, backfilled with gravel, used to filter pollutants and infiltrate storm water.

**Infiltration:** The percolation of water into the ground.

**Integrated Pest Management Plan (IPMP):** A balanced approach to pest management which incorporates the many aspects of plant health care in ways that mitigate harmful environmental impacts and protect human health.

**Landscaping:** The vegetation (plantings), topsoil, rocks, and other surface elements associated with storm water facility design.

**Maintenance (Specifically for Paving):** Includes, slurry sealing, fog sealing, crack sealing, pot hole and square cut patching, overlaying existing asphalt or concrete paving with asphalt or concrete without expanding the size of the impervious area, resurfacing with in-kind material without expanding the size of the impervious area, shoulder grading, practices to maintain the original line and grade, hydraulic capacity, and overall footprint of the road or parking lot, or repair or reconstruction of a road or parking lot due to slope failures, natural disasters, acts of God or other man-made disaster.

**New Development:** New development activity that includes construction, site alteration (e.g., paving, grading, excavating, filling, or clearing) or installation of structures, parking, storage facilities or other impervious surfaces.

**Open Channel:** A fluid passageway which allows part of the fluid to be exposed to the atmosphere.

**Operations and Maintenance (O&M):** The continuing activities required to keep storm water management facilities and their components functioning in accordance with design objectives.

**Outfall / Outlet:** A location where collected and concentrated water is discharged. Outfalls can include discharge from storm water management facilities, drainage pipe systems, and constructed open channels.

**Pervious Surface/Area:** A surface or area with a surface (i.e., soil, loose rock, permeable pavement, etc.) that allows water to infiltrate (soak) into the ground.

**Planter Box:** A structural facility filled with topsoil and gravel and planted with vegetation. The planter is completely sealed, and a perforated collection pipe is placed under the soil and gravel, along with an overflow provision, and directed to an acceptable destination point. The storm water planter receives runoff from impervious surfaces, which is filtered and retained for a period of time.

**Pollutant:** An elemental or physical material that can be mobilized or dissolved by water or air and creates a negative impact to human health and/ or the environment. Pollutants include suspended solids (sediment), heavy metals (such as lead, copper, zinc, and cadmium), nutrients (such as nitrogen and phosphorus), bacteria and viruses, organics (such as oil, grease, hydrocarbons, pesticides, and fertilizers), floatable debris, and increased temperature.

**Pollutants of Concern:** Pollutants that exhibit one or more of the following characteristics: current loadings or historic deposits of the pollutant are impacting the beneficial uses of a receiving water, elevated levels of the pollutant are found in sediments of a receiving water and/or have the potential to bioaccumulate in organisms therein, or the detectable inputs of the pollutant are at concentrations or loads considered potentially toxic to humans and/or flora and fauna.

**Pollution Reduction:** The practice of filtering, retaining, or detaining surface water runoff during and after a storm event for the purpose of maintaining or improving surface and/or groundwater quality.

**Predevelopment:** The existing land use condition prior to the proposed development activity.

**Practicable:** Available and capable of being done, after taking into consideration existing technology, legal issues, and logistics in light of overall project purpose.

**Project Site:** Defined by the parcel boundaries, on a case-by-case basis, as determined by City staff.

**Public Facility:** A street, right-of-way, sewer, drainage, storm water management, or other facility that is either currently owned by the City/County or will be conveyed to the City/County for maintenance responsibility after construction.

**Redevelopment:** Development activity that replaces existing structures, parking, storage facilities, or other impervious surfaces with an equivalent area of new impervious surfaces, and/or expands existing structures, parking or storage facilities by adding new impervious surfaces. Interior remodeling projects and tenant improvements are not considered to be redevelopment.

**Retention Facility:** A facility designed to receive and hold storm water runoff. Rather than storing and releasing the entire runoff volume, retention facilities permanently retain a portion of the water on-site, where it infiltrates, evaporates, or is absorbed by surrounding vegetation. In this way, the full volume of storm water that enters the facility is not released off-site.

**Roadway:** Any paved surface used to carry vehicular traffic (cars/trucks, forklifts, farm machinery, or any other large machinery).



**Runoff:** Storm water flows across the ground surface during and after a rainfall event. Also simply referred to as storm water.

**Storm Water:** Water runoff that originates as precipitation on a particular site, basin, or watershed. Also referred to as runoff.

**Storm Water Management:** The overall culmination of techniques used to reduce pollutants from, detain and/or retain, and provide a destination for storm water to best preserve or mimic the natural hydrologic cycle, to accomplish goals of reducing combined sewer overflows or basement sewer backups, or to fit within the capacity of existing infrastructure.

**Surface Conveyance:** The transport of storm water on the ground surface from one point to another.

**Total Suspended Solids (TSS):** Matter suspended in storm water excluding litter, debris, and other gross solids exceeding 1 millimeter in diameter.

**Underground Injection Control (UIC):** A federal program under the Safe Drinking Water Act, which regulates the injection of water below ground. The intent of the program is to protect groundwater aquifers, primarily those used as a source of drinking water, from contamination.

**Vegetated Facilities:** Storm water management facilities that rely on plantings to enhance their performance. Plantings can provide wildlife habitat and enhance many facility functions, including infiltration, pollutant removal, water cooling, flow calming, and prevention of erosion.

**Vegetated Swale:** A long and narrow, trapezoidal or semicircular channel, planted with a variety of trees, shrubs, and grasses or with a dense mix of grasses. Storm water runoff from impervious surfaces is directed through the swale, where it is slowed and in some cases infiltrated, allowing pollutants to settle out. Check dams are often used to create small ponded areas to facilitate infiltration.

**Water Body:** Water bodies include coastal waters, rivers, sloughs, continuous and intermittent streams and seeps, ponds, lakes, aquifers, and wetlands.

**Watercourse:** A channel in which a flow of water occurs, either continuously or intermittently, with some degree of regularity. Watercourses may be either natural or artificial.

## **APPENDIX B SITE CONDITIONS MAPS**

Maps begin on next page

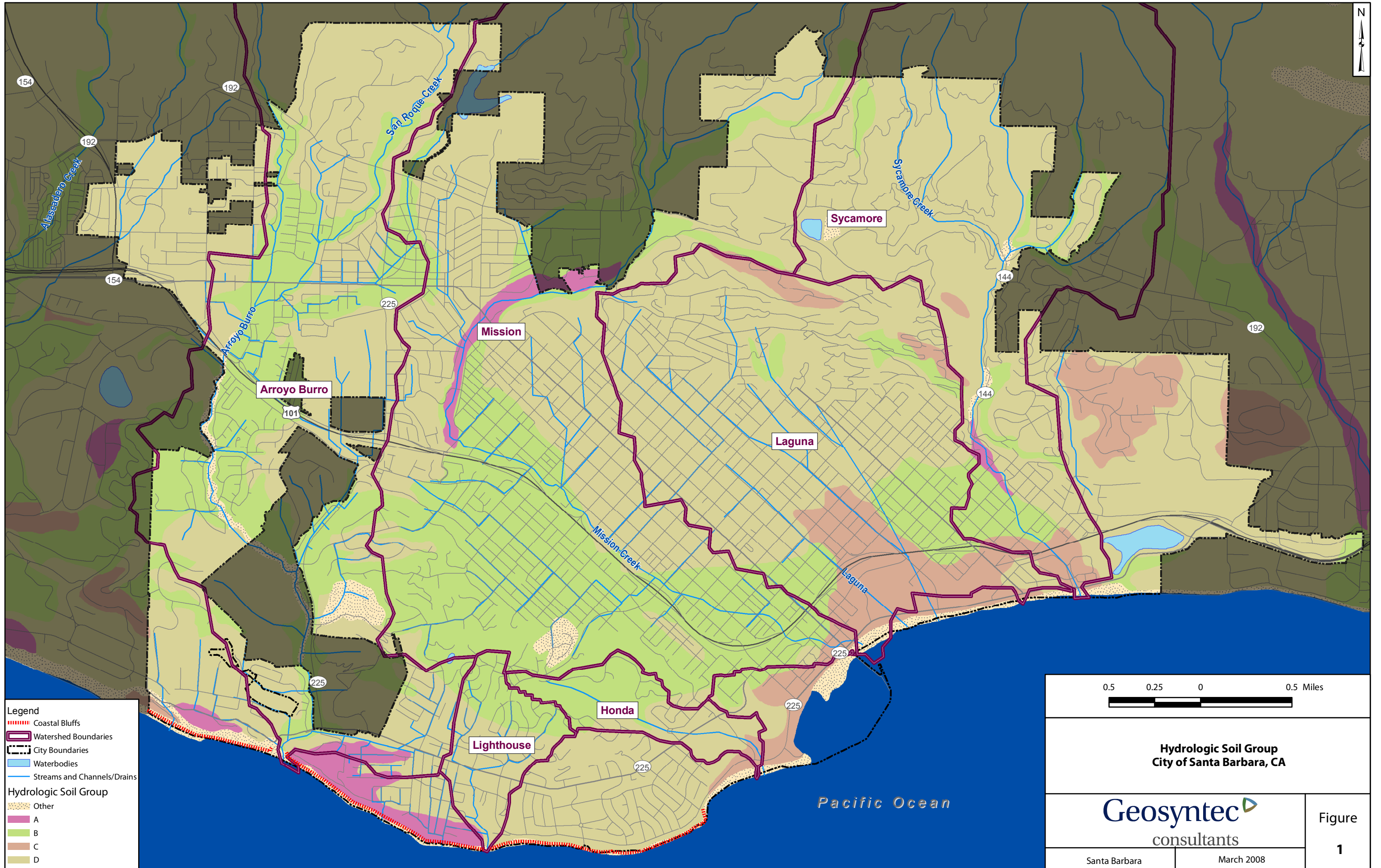

P:\GIS\LA0169\Projects\soils\_hydrogroup.mxd Thursday, February 21, 2008 MTP

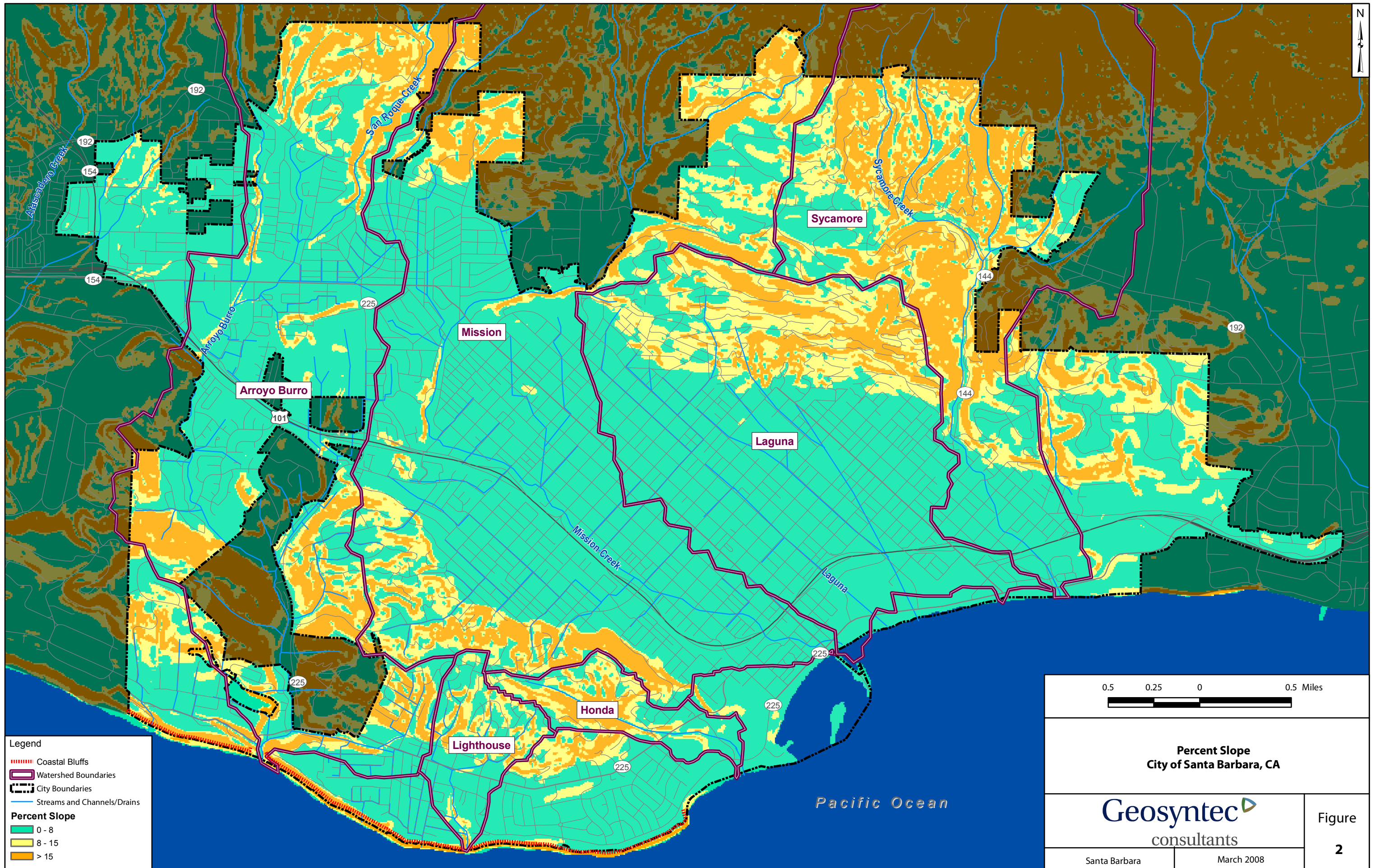

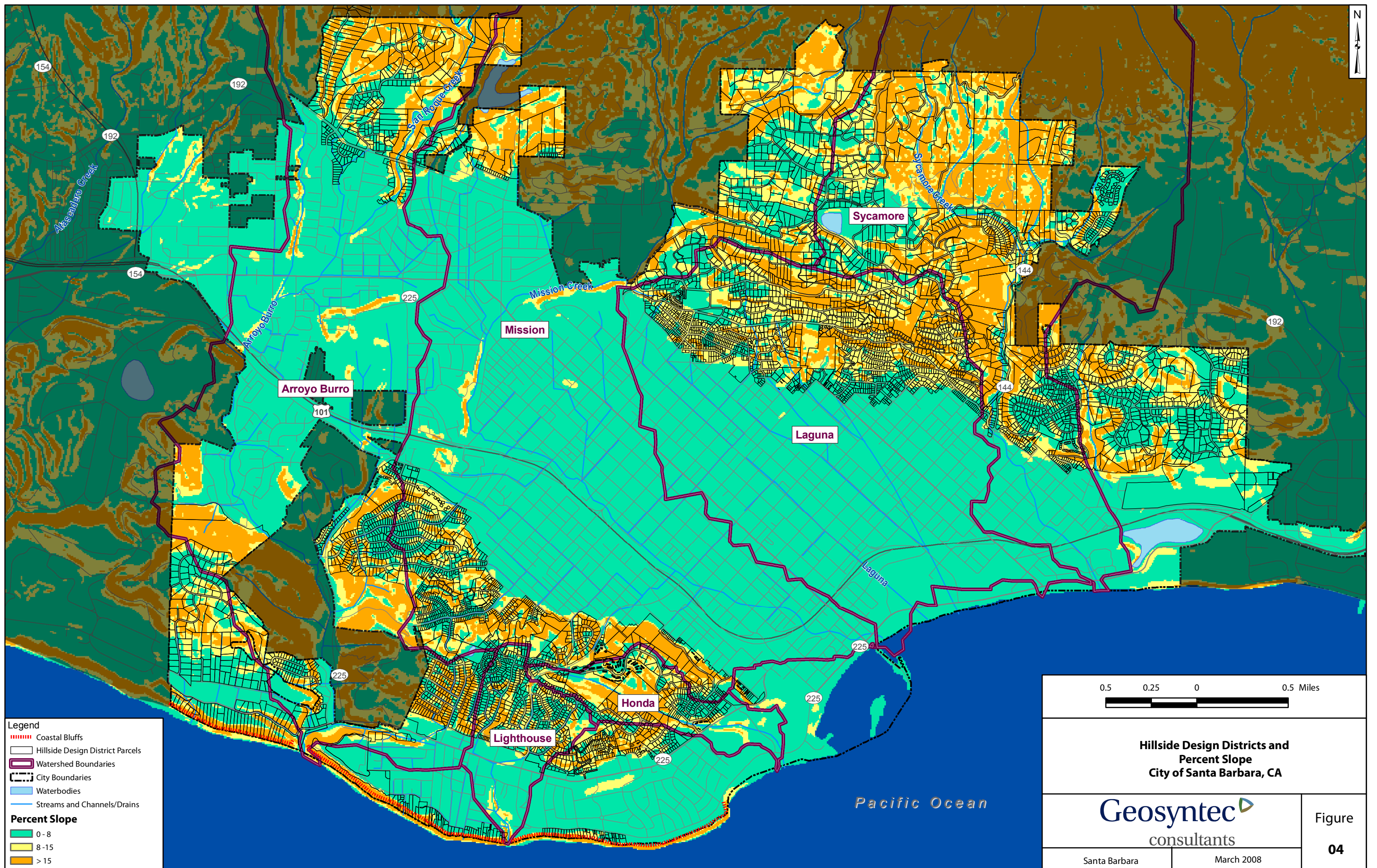

**Legend**

- ▬▬▬▬ Coastal Bluffs
- Hillside Design District Parcels
- Watershed Boundaries
- City Boundaries
- Waterbodies
- ▬▬▬▬ Streams and Channels/Drains

**Percent Slope**

- 0 - 8
- 8 - 15
- > 15

0.5    0.25    0    0.5 Miles

---

**Hillside Design Districts and  
Percent Slope  
City of Santa Barbara, CA**

---

**Geosyntec**  
consultants

---

|               |            |
|---------------|------------|
| Santa Barbara | March 2008 |
|---------------|------------|

Figure  
**04**

P:\GIS\LA0169\Projects\hillside\_design\_districts.mxd Monday, March 10, 2008 MTP

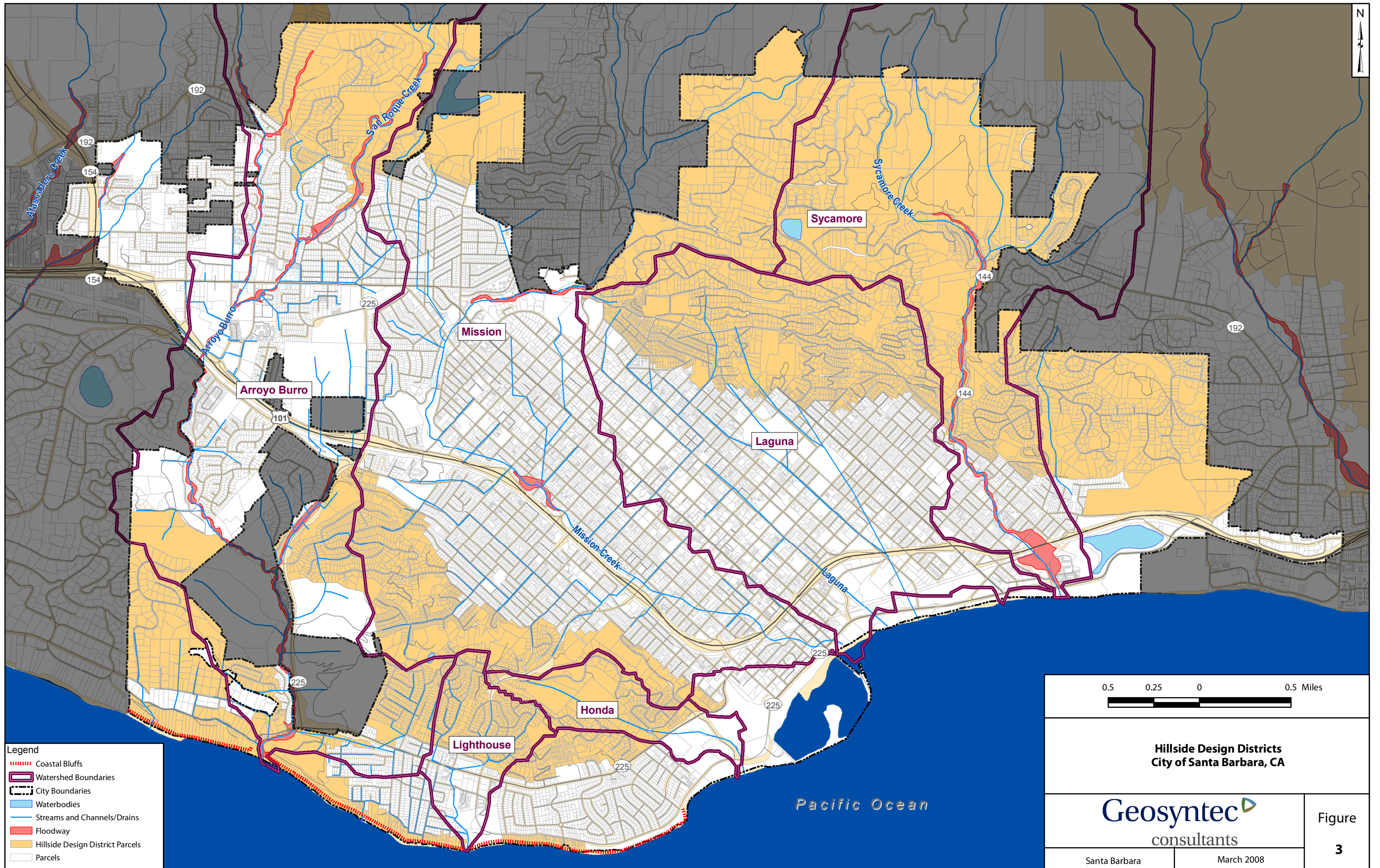

## APPENDIX C BMP SIZING METHODOLOGIES

The following sections reiterate the storm water runoff requirements described in Section 6.2 and provide methodologies for BMP sizing for each of the requirements.

### Maintaining Peak Runoff Discharge Rate Requirements

#### *Requirement*

The requirement for maintaining the peak runoff discharge rate is set by the City's SWMP and based on the **Santa Barbara County Flood Control and Water Conservation District (SBCFC)**. The City's SWMP requires that:

- Storm water runoff BMPs provide detention such that the post-development peak storm water runoff discharge rate shall not exceed the pre-development rate for the 2-, 5-, 10-, and 25-year 24-hour storm events. For redevelopment projects, the net change in peak flow rates are to be compared with the predevelopment condition.

#### *Sizing Methodology*

The following method for sizing storm water runoff BMPs to maintain the pre-development peak storm water runoff discharge rate requirement is an excerpt from the *Santa Barbara County Flood Control and Water Conservation District – Standard Conditions of Project Plan Approval*.

This document can be downloaded at the following website:

<http://www.countyofsb.org/pwd/water/derev.htm>.

- Hydrologic/hydraulic analysis: The hydrologic/hydraulic analysis of detention basins shall be performed by a California-licensed civil engineer using a commercially available version of the Santa Barbara Urban Hydrograph method. Two recommended commercial versions of SBUH are Hydraflow ([www.intelisolve.com](http://www.intelisolve.com)) and HydroCAD ([www.hydrocad.net](http://www.hydrocad.net)). It is also acceptable to use a long-term continuous simulation-based approach in place of the SBUH Method. For some single-family residential projects, an architect or other design professional may produce the analysis, dependent on City staff approval.
- The flowing parameters must be used with the SBUH:
  - Runoff Method: SBUH
  - Pond Routing Method: Storage-Indication
  - Rainfall Distribution: SCS 24-hr, Type I distribution
  - Antecedent Moisture Condition: AMC II
  - Hydrograph ordinate time increment: 0.10 hour
  - Rainfall Amounts, 24-hour totals in inches:

| Area        | 2-Year   | 5-Year   | 10-Year  | 25-year  |
|-------------|----------|----------|----------|----------|
| South Coast | 3.20 in. | 4.61 in. | 5.55 in. | 6.71 in. |

- Hydrologic soil groups for areas within Santa Barbara County can be determined on-line at: <http://websoilsurvey.nrcs.usda.gov/> and/or by viewing the Hydrologic Soil Group Map provided in Appendix B of this manual.
- Curve numbers for hydrologic soil groups per Tables 2-2A through 2-2D (Runoff Curve Numbers) of "TR-55, Urban Hydrology for Small Watersheds," published by USDA NRCS. TR-55 may be viewed on-line at: [ftp://ftp.wcc.nrcs.usda.gov/downloads/hydrology\\_hydraulics/tr55/tr55.pdf](ftp://ftp.wcc.nrcs.usda.gov/downloads/hydrology_hydraulics/tr55/tr55.pdf)
- Information on computing composite curve numbers to account for unconnected impervious areas and low-impact development (LID) design components is given in TR-55 and "Low-Impact Development Hydrologic Analysis" prepared by Prince George's County, Maryland, a portion of which may be viewed online at: <http://www.countofsb.org/pwd/water/derev.htm>

If LID design elements are considered in the hydrologic analysis of the project, those elements must be guaranteed to remain in place for the lifetime of the project. This guarantee must be demonstrated in the form of a written statement from the owner and/or inclusion in the development's Covenants, Conditions and Restrictions.

- Basin data required to be submitted for review includes:
  - Basin input parameters listed above;
  - Watershed maps;
  - Soil Survey Map/Hydrologic Soil Group for watershed, including copy of Soil Survey Map of subject property;
  - Specifics of proposed development (area, time of concentration, including time of concentration and composite curve number calculations);
  - Proposed basin geometry;
  - Proposed outlet works and resultant outlet works hydraulics;
  - Peak depth, peak outflow, peak storage;
  - Inflow volume, outflow volume;
  - Plotted inflow and outflow hydrographs.

## Volume Reduction Requirements

### *Requirement*

Retain on-site the larger of the following two volumes from the entire project site:

- Volume difference between the pre- and post-development conditions for the 25-year, 24-hour design storm,  $V_{25}$
- Volume difference between the pre- and post-development conditions generated from a one-inch, 24-hr storm event,  $V_{\text{one-inch}}$



*Sizing Methodology*

- Calculate the volume difference between pre- and post-development conditions from the entire project site for the 25-year, 24-hour storm event,  $V_{\text{one-inch}}$ , by:
  - Generating the pre- and post-condition runoff hydrographs for the 25-year, 24-hour storm event using the County of Santa Barbara Urban Hydrograph Method (SBUH) as described above in the “maintaining peak discharge rate” section for the 25-year, 24-hour design storm for the South Coast Region (including the City of Santa Barbara) of *6.71 inches*. It is also acceptable to use an alternative long-term continuous simulation-based approach in place of the SBUH Method.
  - Calculating the volume difference between the pre- and post-development conditions for the 25-year, 24-hour storm event,  $V_{25}$ , using the following equation based on the SCS synthetic triangular unit hydrograph method:

$$V_{25} = 0.5 * \Delta Q_{25} * 2.67 * T_c$$

Where:

- $V_{25}$  = volume of runoff to be retained on-site (ft<sup>3</sup>)
- $\Delta Q_{25}$  = the difference in the  $Q_{25}$  peak runoff rate for pre- and post development conditions as determined from the hydrographs developed by the SBUH method
- $T_c$  = time of concentration = 720 seconds

- Calculate the volume generated from a one-inch, 24 hour storm event,  $V_{\text{one-inch}}$  from the entire project site. There are two options for sizing which are up to the discretion of the designer:
  - **Option 1:** Size the BMPs based on the volume of runoff generated from a one-inch, 24-hour storm using the SBUH method. This is a direct calculation of the volume that runs off a site over the 24-hr duration of a one-inch storm and BMPs using this method would be sized to retain this volume which does not account for infiltration that occurs in the BMP during the 24-hr storm period. This option gives you a larger BMP size than Option 2.
  - **Option 2:** Size the BMPs by generating a runoff hydrograph for a one-inch, 24-hour storm using the SBUH method and then routing the runoff hydrograph through the BMP over the 24-hr duration of the storm and generating the volume of runoff based on the routed runoff hydrograph. This calculation would account for the infiltration that takes place in the BMP during the storm so that the actual BMP size would be smaller than Option 1.
- Determine which volume is the larger of the two methods ( $V_{25}$  or  $V_{\text{one-inch}}$ ). The larger volume is the design volume reduction,  $V_{\text{reduction}}$ , that shall be retained on-site.

## Water Quality Treatment Requirements

### Requirements

Water quality treatment requirements are differentiated based on whether the BMP is volumetric-based or flow-based. The criteria for both are as follows:

- Volume-based BMPs shall be sized based on a one-inch 24-hr design storm from the entire project site (not just the new or redeveloped area).
- Flow-based BMPs shall be sized based on a constant rainfall intensity of 0.25 in/hr from the entire project site (not just the new or redeveloped area) Water quality treatment shall be maintained at this rate for a minimum of four hours.

### Sizing Methodology

- The following table identifies which storm water runoff BMPs are designed to treat the flow-based water quality design flow rate ( $Q_{wq}$ ), or the volume-based water quality design treatment volume ( $V_{wq}$ ).

| Manual Section | Storm Water Runoff BMP        | Design Basis |
|----------------|-------------------------------|--------------|
| 6.6.2          | Vegetated Swale Filter        | $Q_{wq}$     |
| 6.6.3          | Vegetated Strip Filter        |              |
| 6.11           | Proprietary Devices           |              |
| 6.6.1          | Bioretention                  | $V_{wq}$     |
| 6.7            | Infiltration Basin            |              |
| 6.7            | Infiltration Trench           |              |
| 6.7            | Dry Well                      |              |
| 6.9.1          | Cistern/Rain Barrel           |              |
| 6.9.2          | Planter Box                   |              |
| 6.10.1         | Constructed Treatment Wetland |              |
| 6.10.2         | Wet Retention Basin           |              |
| 6.10.3         | Dry Extended Detention Basin  |              |
| 6.11           | Proprietary Devices           |              |

- The water quality design treatment volume,  $V_{wq}$ , for **volume-based BMPs** is equivalent to the volume calculated above (see volume reduction requirement section) for the one-inch, 24-hour storm,  $V_{one-inch}$ , using the SBUH method for a one-inch, 24-hr design storm.

The water quality design flow rate,  $Q_{wq}$ , for **flow-based BMPs** is calculated using the Rational Method assuming a design storm with constant intensity of 0.25 in/hr. The runoff coefficient “(0.05 + 0.9\*IMP)” is based on *Controlling Urban Runoff: A Practical Manual for Planning and Designing Urban Best Management Practices* (T. Schueler, 1987).

- This equation is as follows.

$$Q_{wq} = (0.05 + 0.9 * IMP) * 0.25 * A$$

Where:

- $Q_{wq}$  = water quality design flow rate (cfs)
- IMP = percentage of tributary area draining to the flow-based BMP that is impervious, defined as the directly connected impervious area fraction. For more information on computing connected impervious areas, see <http://www.countofsb.org/pwd/water/derev.htm>.
- A = tributary area draining to the flow-based BMP (acres)

### Meeting Storm Water Runoff Requirements Simultaneously

It shall be noted that the volume reduction requirements and water quality treatment requirements are not additive and can be met simultaneously in many cases. Meeting the volume reduction requirements for a specific volume also meets the water quality treatment requirement. Storm water runoff BMPs that allow for infiltration shall be sized using a design volume,  $V_{design}$ , which is the larger of the volume reduction and water quality treatment requirements. Storm water runoff BMPs that do not allow for infiltration will only receive credit towards meeting the water quality treatment requirements. Other storm water runoff BMPs would then need to be used for meeting the volume reduction requirements. See Section 6.5 for suggested strategies for meeting the storm water runoff requirements.

---

**APPENDIX D BMP DESIGN EXAMPLES**

|   |      |
|---|------|
| Bioretention Worksheet.....                     | D-2  |
| Bioretention Design Example.....                | D-4  |
| Vegetated Swale Filter Worksheet.....           | D-7  |
| Vegetated Swale Filter Design Example.....      | D-12 |
| Vegetated Filter Strip Worksheet .....          | D-16 |
| Vegetated Filter Strip Design Example.....      | D-18 |
| Sand Filter Worksheet .....                     | D-20 |
| Sand Filter Design Example.....                 | D-23 |
| Infiltration BMP Worksheet.....                 | D-27 |
| Infiltration BMP Design Example.....            | D-29 |
| Permeable Pavement Worksheet.....               | D-32 |
| Permeable Pavement Design Example.....          | D-35 |
| Constructed Treatment Wetland Worksheet.....    | D-38 |
| Constructed Treatment Wetland Design Example.   | D-43 |
| Wet Retention Basin Worksheet.....              | D-48 |
| Wet Retention Basin Design Example.....         | D-52 |
| Dry Extended Detention Basin Worksheet.....     | D-57 |
| Dry Extended Detention Basin Design Example.... | D-60 |

Bioretention Worksheet

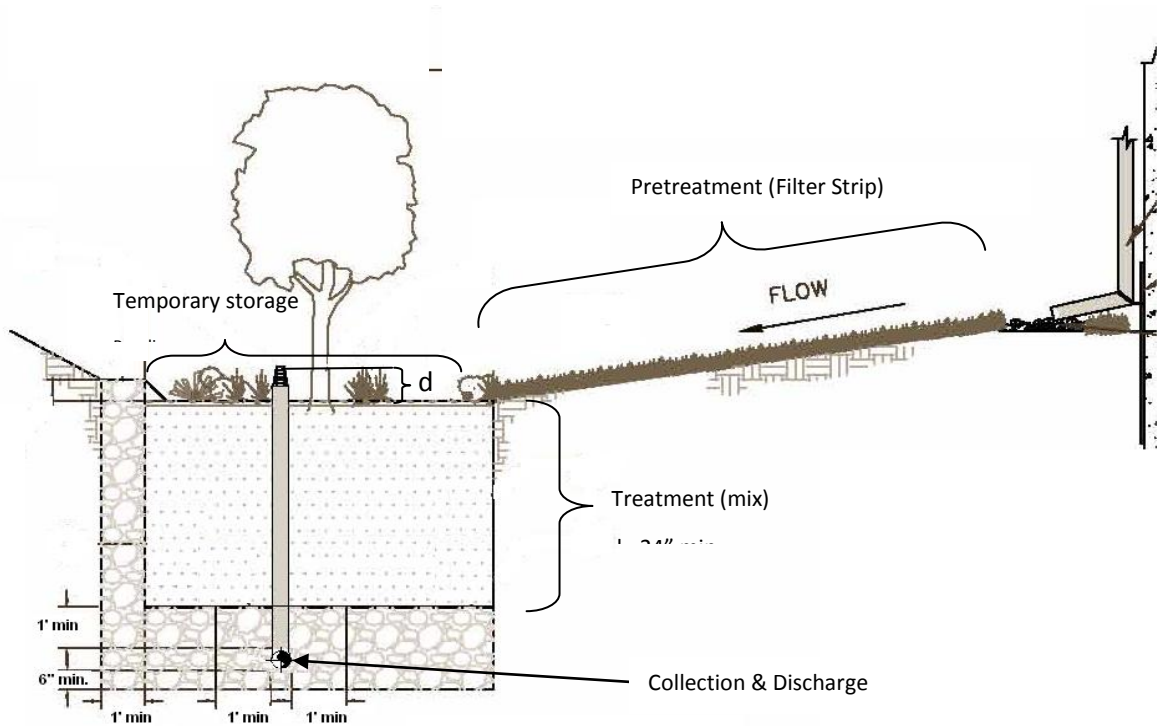

Figure D-1: Bioretention Area Cross-Section

Refer to Figure D-1 and Figure 6-2 for the description of the geometric variables.

| <b>Step 1: Determine design volume reduction, <math>V_{\text{reduction}}</math></b>  |  |
|--|--|
| 1-1. Enter the volume difference between the pre- and post-development conditions for the 25-yr, 24-hr design storm, $V_{25}$ , calculated using SBUH method, Appendix C   | $V_{25} =$ _____ $\text{ft}^3$               |
| 1-2. Enter the volume generated from a one-inch, 24-hr storm event, $V_{\text{one-inch}}$ , calculated using SBUH method, Appendix C                                       | $V_{\text{one-inch}} =$ _____ $\text{ft}^3$  |
| 1-3. Determine design volume reduction which is the larger of $V_{25}$ and $V_{\text{one-inch}}$ and is the volume to be retained on-site                                  | $V_{\text{reduction}} =$ _____ $\text{ft}^3$ |
| <b>Step 2: Determine storm water quality design volume, <math>V_{\text{wq}}</math></b>   |  |
| 2-1. Determine the water quality design volume, $V_{\text{wq}}$ , using SBUH method, Appendix C ( <u>Note</u> : $V_{\text{wq}}$ is always equal to $V_{\text{one-inch}}$ ) | $V_{\text{wq}} =$ _____ $\text{ft}^3$        |

|  |   |
|--|---|
| <b>Step 3: Determine design volume, <math>V_{\text{design}}</math> (for sizing)</b>  |   |
| 3-1. If underdrain system is used, $V_{\text{design}} = V_{\text{wq}}$<br>If there is no underdrain system, $V_{\text{design}} =$ the larger of $V_{\text{reduction}}$ and $V_{\text{wq}}$   | $V_{\text{design}} =$ _____ $\text{ft}^3$ |
| <b>Step 4: Pretreatment</b>  |   |
| 4-1. If pretreatment is required please go the vegetated filter strip worksheet, Appendix C  |   |
| <b>Step 5: Calculate bioretention area</b>   |   |
| 5-1. Enter thickness of planting mix (min. 24"), $l$   | $l =$ _____ in                            |
| 5-2. Enter storage depth (12" max.) above the filter, $d$  | $d =$ _____ in                            |
| 5-3. Enter infiltration rate, $k_{\text{design}}$ ( <b>Note:</b> infiltration rate of planting soil. If no underdrain, infiltration rate of native subsoil or fill). If no underdrains, see Step 4 of the Infiltration BMP Worksheet, Appendix D to calculate $k_{\text{design}}$ ). | $k_{\text{design}} =$ _____ in/hr         |
| 5-4. Enter drawdown time, $t$  | $t =$ _____ hr                            |
| 5-5. Calculate bioretention area, $A_{\text{sf}} = (V_{\text{design}} \bullet l) / [(t \bullet k_{\text{design}} / 12) \bullet (l + d)]$   | $A_{\text{sf}} =$ _____ $\text{ft}^2$     |
| <b>Step 6: Calculate underdrain system flow rate (if an underdrain is provided)</b>  |   |
| 6-1. Calculate filtered flow rate to be conveyed by the longitudinal drain pipe, $Q_f = k_{\text{design}} \bullet A_{\text{sf}} / 43200$ ( <b>Note:</b> for this example, step 6-1 is equivalent to step 5-1 of the Sand Filter Worksheet, Appendix D).                              | $Q_f =$ _____ cfs                         |
| 6-2. Please follow steps 5-2 through 5-7 of the Sand Filter Worksheet, Appendix D to calculate the underdrain system capacity.   |   |
| <b>Step 7: Provide Conveyance Capacity for Flows Higher than <math>Q_{\text{wq}}</math></b>  |   |
| 7-1. An emergency overflow must be provided if the bioretention area is placed online or in the event the surface area becomes clogged.  |   |

## Bioretention Design Example

Bioretention areas have several components that allow the pretreatment, spreading, filtration, collection and discharge of the incoming flows.

### Step 1: Determine Storm Water Quality Design Volume Reduction, $V_{\text{reduction}}$

| Step 1: Determine design volume reduction, $V_{\text{reduction}}$  |   |
|--|---|
| 1-1. Enter the volume difference between the pre- and post-development conditions for the 25-yr, 24-hr design storm, $V_{25}$ , calculated using SBUH method, Appendix C | $V_{25} = \frac{20}{\quad} \text{ft}^3$                   |
| 1-2. Enter the volume generated from a one-inch, 24-hr storm event, $V_{\text{one-inch}}$ , calculated using SBUH method, Appendix C                                     | $V_{\text{one-inch}} = \frac{25,700}{\quad} \text{ft}^3$  |
| 1-3. Determine design volume reduction which is the larger of $V_{25}$ and $V_{\text{one-inch}}$ and is the volume to be retained on-site                                | $V_{\text{reduction}} = \frac{25,700}{\quad} \text{ft}^3$ |

### Step 2: Determine Storm Water Quality Design Volume, $V_{\text{wq}}$

| Step 2: Determine storm water quality design volume, $V_{\text{wq}}$   |  |
|--|--|
| 2-1. Determine the water quality design volume, $V_{\text{wq}}$ , using SBUH method, Appendix C ( <u>Note</u> : $V_{\text{wq}}$ is always equal to $V_{\text{one-inch}}$ ) | $V_{\text{wq}} = \frac{25,700}{\quad} \text{ft}^3$ |

### Step 3: Determine Design Volume, $V_{\text{design}}$

| Step 3: Determine design volume, $V_{\text{design}}$ (for sizing)   |  |
|---|--|
| 3-1. If underdrain system is used, $V_{\text{design}} = V_{\text{wq}}$ . If there is no underdrain system, $V_{\text{design}} =$ the larger of $V_{\text{reduction}}$ and $V_{\text{wq}}$ | $V_{\text{design}} = \frac{25,700}{\quad} \text{ft}^3$ |

### Step 4: Pretreatment

| Step 4: Pretreatment  |  |
|---|--|
| 4-1. If pretreatment is required please go the vegetated filter strip worksheet, Appendix C |  |

The bioretention areas that collect runoff from residential roofs, sidewalks, driveways, or other “cleaner” surfaces do not require pretreatment. If the runoff originates from locations other than “clean” surfaces, then pretreatment is required. Please refer to Vegetated Filter Strip Worksheet (Appendix D) for detailed calculations.

**Step 5: Determine bioretention area footprint area**

A bioretention area is designed with two components: (1) temporary storage reservoir to store runoff, and (2) a planting soil bed (planting soil mixed with sand content = 70%) through which the stored runoff must percolate to obtain treatment.

The simple sizing method does not route flows through the planting soil which would allow a more accurate sizing of the facility. The area of the planting soil bed is determined based on the simple assumption that inflow is immediately discharged through the filter at a rate which is equivalent to drawing down the maximum 12” storage depth and the planting soil depth (min. depth 24”) over 48 hours. If the planting soil bed depth is 24”, the minimum infiltration rate would be (12” + 24”)/48 hr = 0.875 in/hr. Infiltration rates for bioretention area planting soil mixes are often in the range of 1 in/hr to 6 in/hr depending on the pollutants of concern to be targeted for removal.

| Step 5: Calculate bioretention area  |                |                       |
|--|----------------|-----------------------|
| 5-1. Enter thickness of planting mix (min. 24”), l   | l =            | 24 in                 |
| 5-2. Enter storage depth (12" max.) above the filter, d  | d =            | 12 in                 |
| 5-3. Enter infiltration rate, $k_{design}$ (Note: infiltration rate of planting soil. If no underdrain, infiltration rate of native subsoil or fill). If no underdrains, see Step 4 of the Infiltration BMP Worksheet, Appendix D to calculate $k_{design}$ ). | $k_{design}$ = | 1.5 in/hr             |
| 5-4. Enter drawdown time, t  | t =            | 48 hr                 |
| 5-5. Calculate bioretention area, $A_{sf} = (V_{design} \cdot l) / [(t \cdot k_{design} / 12) \cdot (l + d)]$  | $A_{sf}$ =     | 2,856 ft <sup>2</sup> |



**Step 6: Calculate Underdrain System**

If an underdrain is required, please see the Sand Filter underdrain calculation, Appendix D. All underdrain pipes must be 6 inches or greater to facilitate cleaning.

| <b>Step 6: Calculate underdrain system flow rate (if an underdrain is provided)</b>  |         |                                     |
|--|---------|-------------------------------------|
| 6-1. Calculate filtered flow rate to be conveyed by the longitudinal drain pipe, $Q_f = k \cdot A_{sf} / 43200$ (Note: for this example, step 6-1 is equivalent to step 5-1 of the Sand Filter Worksheet, Appendix D). | $Q_f =$ | $\frac{0.099}{\quad\quad\quad}$ cfs |
| 6-2. Please follow steps 5-2 through 5-7 of the Sand Filter Worksheet, Appendix D to calculate the underdrain system capacity.   |         |                                     |

**Step 7: Provide Conveyance Capacity for Flows Higher than  $Q_{wq}$**

Provide conveyance capacity for flows higher than  $Q_{wq}$ , water quality design flow rate, to bypass the bioretention area. An emergency overflow must also be provided in the event that the surface area becomes clogged or the bioretention area is placed online.

Vegetated Swale Filter Worksheet

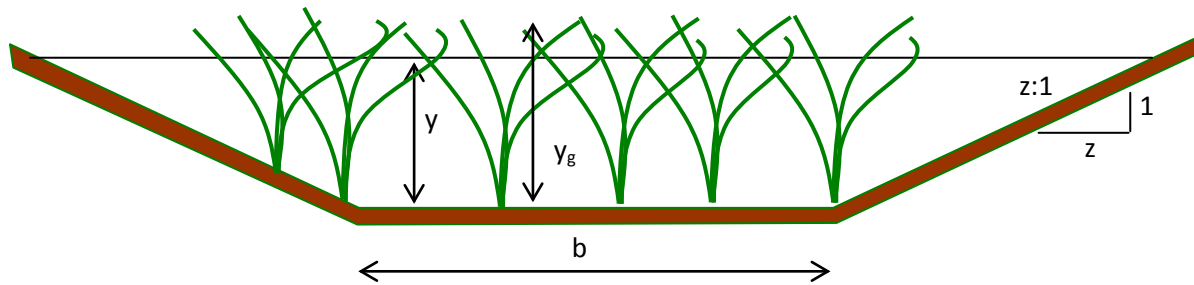

Figure D-2: Vegetated swale filter cross-section

Refer to Figure D-2, Figure 6-5, and Figure 6-6 for a diagrammatic description of the geometric variables.

| Step 1: Determine design volume reduction, $V_{\text{reduction}}$ (if applicable)  |  |
|--|--|
| 1-1. Enter the volume difference between the pre- and post-development conditions for the 25-yr, 24-hr design storm, $V_{25}$ , calculated using SBUH method, Appendix C | $V_{25} =$ _____ $\text{ft}^3$               |
| 1-2. Enter the volume generated from a one-inch, 24-hr storm event, $V_{\text{one-inch}}$ , calculated using SBUH method, Appendix C                                     | $V_{\text{one-inch}} =$ _____ $\text{ft}^3$  |
| 1-3. Determine the design volume reduction, $V_{\text{reduction}}$ , which is the larger of $V_{25}$ and $V_{\text{one-inch}}$ and is the volume to be retained on-site  | $V_{\text{reduction}} =$ _____ $\text{ft}^3$ |
| <b>Note:</b> Volume reduction credit is only provided for vegetated swale filters that include a gravel drainage layer to encourage infiltration.                        |  |
| -  |  |
| Step 2: Determine storm water quality design flow rate, $Q_{\text{wq}}$  |  |
| 2-1. Enter drainage area, A  | A = _____ acres                              |
| 2-2. Enter impervious fraction, Imp  | Imp = _____                                  |
| 2-3. Calculate runoff coefficient, $C = (0.9 \cdot \text{Imp} + 0.05)$   | C = _____                                    |
| 2-4. Calculate the water quality design flow rate, $Q_{\text{wq}}$ , based on a constant rainfall intensity of 0.25 in/hr, Appendix C                                    | $Q_{\text{wq}} =$ _____ cfs                  |

| Step 3: Determine design volume for sizing gravel drainage layer, if applicable   |   |
|---|---|
| 3-1. $V_{\text{design}} = V_{\text{reduction}}$   | $V_{\text{design}} =$ _____ $\text{ft}^3$ |
| 3-2. Please follow Steps 3 through 5 of the Permeable Pavement Worksheet, Appendix D to calculate the size of the gravel drainage layer |   |

| <b>Step 4: Calculate flow depth, d, and swale bottom width, b</b>  |                           |
|--|---------------------------|
| 4-1. Enter Manning's roughness coefficient for shallow flow conditions (0.2 typical), n  | n = _____                 |
| 4-2. Enter expected vegetation height, $y_v$   | $y_v$ = _____ in          |
| 4-3. Calculate design flow depth (0.33 ft max), $d = y_v/18$   | d = _____ ft              |
| 4-4. Enter longitudinal slope (along direction of flow), s   | s = _____ ft/ft           |
| 4-5. Enter side slope length per unit height (e.g. 3 if side slope are 3H :1V), Z  | Z = _____                 |
| 4-6. Calculate bottom width of swale assuming a trapezoidal channel shape, $b = Q_{wq}n_{wq}/1.49y^{1.67}s^{0.5}$  | b = _____ ft              |
| 4-7. Calculate $AR^{2/3}$ , using $Q_{wq}n/1.49s^{0.5}$ (Equation 6-5)   | $AR^{2/3}$ = _____        |
| 4-8. Calculate the wetted area, A  | A = _____ ft <sup>2</sup> |
| 4-9. Calculate the wetted perimeter, P   | P = _____ ft              |
| 4-10. Calculate the hydraulic radius, R  | R = _____ ft              |
| 4-11. Re-calculate $AR^{2/3}$ , using the A and R calculated in steps 4-8 and 4-10. Change b until the $AR^{2/3}$ calculated in this step is equal to $AR^{2/3}$ calculated in 4-7.  | $AR^{2/3}$ = _____        |
| 4-12. If b is between 2 and 10 feet, go to Step 5  |                           |
| 4-13. If $b < 2$ ft, set $b = 2$ ft and go to Step 4-4 and decrease swale slope (0.015 ft/ft max.). If slope cannot be changed due to site constraints, go to Step 4-14.   |                           |
| 4-14. If $b < 2$ ft and slope is maximized, set $b = 2$ ft and go to Step 4-2 and decrease vegetation height   |                           |
| 4-15. If b is greater than 10 ft, one of the following design adjustments must be made:<br>1) increase the longitudinal slope to a maximum of 0.06 ft/ft, and repeat steps 4-7 to 4-11 above.<br>2) include a flow splitter longitudinally along the swale bottom (Figure 6-6 and Appendix F) at least three-quarters of the swale length (beginning at the inlet) |                           |
| <b>Step 5: Determine design flow velocity</b>  |                           |
| 5-1. Calculate design flow velocity, $v_{wq} = Q_{wq}/A$   | $v_{wq}$ = _____ ft/s     |
| 5-2. If the design flow velocity is higher than 1ft/s go to Step 4-4 and decrease the slope, if possible   |                           |

| Step 6: Calculate swale length   |            |                       |
|--|------------|-----------------------|
| 6-1. Enter target residence time (7 minutes minimum), $t_{HR}$   | $t_{HR} =$ | _____ min             |
| 6-2. Calculate swale length, $L = v_{wq} \cdot 60 \cdot t_{HR}$  | $L =$      | _____ ft              |
| 6-3. If L is too long for the site, proceed to step 5 to adjust the swale layout   |            |                       |
| Step 7: Adjust swale layout to fit within site constraints   |            |                       |
| 7-1. Choose a reduced swale length, $L_f$  | $L_f =$    | _____ ft              |
| 7-2. Recalculate flow velocity, $v_{wq} = L_f / (t_{HR} \cdot 60)$   | $v_{wq} =$ | _____ ft/s            |
| 7-3. Recalculate cross-sectional area, $A_{wq} = Q_{wq} / v_{wq}$  | $A_{wq} =$ | _____ ft <sup>2</sup> |
| 7-4. Calculate an increased bottom width, $b_f = (A_{wq} - Zy^2) / y$  | $b_f =$    | _____ ft              |
| 7-5. Recalculate longitudinal slope assuming a rectangular channel shape, $s_f = [Q_{wq} n_{wq} / (1.49 A_{wq} y^{0.67})]^2$                                   | $s_f =$    | _____ ft/ft           |
| 7-6. If $s_f$ is between 1.5% and 6%, the swale design is acceptable for water quality, proceed to Step 6  |            |                       |
| 7-7. If $s_f$ is between 1% and 1.5%, the swale design is acceptable for water quality with underdrains (see design requirements). Proceed to Step 6.          |            |                       |
| 7-8. If $s_f$ is <1%, the swale design is unacceptable. Consider subdividing drainage area and repeat all above steps, or choose a different BMP for the site. |            |                       |

**Step 8: Provide conveyance capacity for flows higher than  $Q_{wq}$**

8-1. If the swale already includes a high-flow bypass to convey flows higher than the water quality design flow rate, skip this step and verify that all parameters meet design requirements to complete sizing.

8-2. If swale does not include a high-flow bypass, check the swale size for the peak discharge rate that will be conveyed in the swale. If online, the peak discharge rate is the 100-yr, 24-hr design storm calculated using the SBUH method (See Appendix C). Calculate the peak discharge velocity,  $V_{peak} = Q_{peak}/A_{swale}$ , where  $Q_{peak}$  = the peak discharge rate (cfs) and  $A_{swale}$  = the cross-sectional area of the swale including freeboard (ft<sup>2</sup>)

$$V_{peak} = \underline{\hspace{2cm}} \text{ ft/s}$$

8-3. If  $V_{peak} > 3.0$  feet per second, return to Step 2 and increase the bottom width or flatten the longitudinal slope as necessary to reduce the peak discharge flow velocity to 3.0 feet per second or less. If the longitudinal slope is flattened, the swale bottom width must be recalculated (Step 2) and must meet all design criteria.

## Vegetated Swale Filter Design Example

### Step 1: Determine Storm Water Quality Design Volume Reduction, $V_{\text{reduction}}$

| Step 1: Determine design volume reduction, $V_{\text{reduction}}$ (if applicable)  |  |
|--|--|
| 1-1. Enter the volume difference between the pre- and post-development conditions for the 25-yr, 24-hr design storm, $V_{25}$ , calculated using SBUH method, Appendix C | $V_{25} = \underline{\quad 20 \quad} \text{ ft}^3$                   |
| 1-2. Enter the volume generated from a one-inch, 24-hr storm event, $V_{\text{one-inch}}$ , calculated using SBUH method, Appendix C                                     | $V_{\text{one-inch}} = \underline{\quad 25,700 \quad} \text{ ft}^3$  |
| 1-3. Determine the design volume reduction, $V_{\text{reduction}}$ , which is the larger of $V_{25}$ and $V_{\text{one-inch}}$ and is the volume to be retained on-site, | $V_{\text{reduction}} = \underline{\quad 25,700 \quad} \text{ ft}^3$ |
| <b>Note:</b> Volume reduction credit is only provided for vegetated swale filters that include a gravel drainage layer to encourage infiltration.                        |  |
| -  |  |

### Step 2: Determine Storm Water Quality Design Flow

For this design example, a 10-acre residential development with a 60% total impervious area is considered. Flow-based sizing as described in Appendix C is assumed. Therefore, the design intensity is 0.25 in/hr.

| Step 2: Determine storm water quality design flow rate, $Q_{\text{wq}}$   |  |
|---|--|
| 2-1. Enter drainage area, A   | $A = \underline{\quad 10 \quad} \text{ acres}$             |
| 2-2. Enter impervious fraction, Imp   | $\text{Imp} = \underline{\quad 0.60 \quad}$                |
| 2-3. Calculate runoff coefficient, $C = (0.9 \cdot \text{Imp} + 0.05)$  | $C = \underline{\quad 0.59 \quad}$                         |
| 2-4. Calculate the water quality design flow rate, $Q_{\text{wq}}$ , based on a constant rainfall intensity of 0.25 in/hr, Appendix C | $Q_{\text{wq}} = \underline{\quad 1.48 \quad} \text{ cfs}$ |

### Step 3: Determine design volume for sizing gravel drainage layer

| Step 3: Determine design volume for sizing gravel drainage layer  |   |
|---|---|
| 3-1. $V_{\text{design}} = V_{\text{reduction}}$   | $V_{\text{design}} = \underline{\quad 25,700 \quad} \text{ ft}^3$ |
| 3-2. Please follow Steps 3 through 5 of the Permeable Pavement Worksheet, Appendix D to calculate the gravel drainage layer |   |

**Step 4: Calculate flow depth, d, and swale bottom width**

The swale bottom width is calculated based on Manning's equation. The grass height in the swale will be maintained at 6-inches. Therefore, the design flow depth is assumed to be 2/3 of 4 inches, or 4 inches (0.33 ft). The default Manning's roughness coefficient is assumed appropriate for expected vegetation density and design depth.

| <b>Step 4: Calculate flow depth, d, and swale bottom width, b</b>  |                                    |
|--|------------------------------------|
| 4-1. Enter Manning's roughness coefficient for shallow flow conditions (0.2 typical), n  | n = 0.2                            |
| 4-2. Enter expected vegetation height, y <sub>v</sub>  | y <sub>v</sub> = $\frac{6}{12}$ in |
| 4-3. Calculate design flow depth (0.33 ft max), d = y <sub>v</sub> /18   | d = $\frac{0.33}{12}$ ft           |
| 4-4. Enter longitudinal slope (along direction of flow), s   | s = $\frac{0.04}{100}$ ft/ft       |
| 4-5. Enter side slope length per unit height (e.g. 3 if side slope are 3H :1V), Z  | Z = 3                              |
| 4-6. Calculate bottom width of swale assuming a trapezoidal channel shape, b = Q <sub>wq</sub> n <sub>wq</sub> /1.49y <sup>1.67</sup> s <sup>0.5</sup>   | b = 9.0 ft                         |
| 4-7. Calculate AR <sup>2/3</sup> , using Q <sub>wq</sub> n /1.49s <sup>0.5</sup> (Equation 6-5)  | AR <sup>2/3</sup> = 1.0            |
| 4-8. Calculate the wetted area, A  | A = 3.3 ft <sup>2</sup>            |
| 4-9. Calculate the wetted perimeter, P   | P = 11.1 ft                        |
| 4-10. Calculate the hydraulic radius, R  | R = 0.3 ft                         |
| 4-11. Re-calculate AR <sup>2/3</sup> , using the A and R calculated in steps 4-8 and 4-10. Change b until the AR <sup>2/3</sup> calculated in this step is equal to AR <sup>2/3</sup> calculated in 4-7. | AR <sup>2/3</sup> = 1.0            |
| 4-12. If b is between 2 and 10 feet, go to Step 5  |                                    |
| 4-13. If b < 2 ft, set b = 2 ft and go to Step 4-4 and decrease swale slope (0.015 ft/ft max.). If slope cannot be changed due to site constraints, go to Step 4-14.                                     |                                    |
| 4-14. If b < 2 ft and slope is maximized, set b= 2 ft and go to Step 4-2 and decrease vegetation height  |                                    |
| 4-15. If b is greater than 10 ft, one of the following design adjustments must be made:  |                                    |
| 1) increase the longitudinal slope to a maximum of 0.06 ft/ft, and repeat steps 4- to 4-11 above.  |                                    |
| 2) include a flow splitter longitudinally along the swale bottom (Figure 6-6 and Appendix F) at least three-quarters of the swale length (beginning at the inlet)  |                                    |



**Step 5: Determine Design Flow Velocity**

| Step 5: Determine design flow velocity  |   |
|---|---|
| 5-1. Calculate design flow velocity, $v_{wq} = Q_{wq}/A$  | $v_{wq} = \frac{0.4}{\quad} \text{ ft/s}$ |
| 5-2. If the design flow velocity is higher than 1 ft/s go to Step 4-4 and decrease the slope, if possible |   |

**Step 6: Calculate Swale Length**

Using the design flow velocity and a minimum residence time of 7 minutes, the length of the swale is calculated as follows. The swale length must be a minimum of 100 ft.

| Step 6: Calculate swale length   |   |
|--|---|
| 6-1. Enter target residence time (7 minutes minimum), $t_{HR}$                   | $t_{HR} = \frac{10}{\quad} \text{ min}$ |
| 6-2. Calculate swale length, $L = v_{wq} \cdot 60 \cdot t_{HR}$                  | $L = \frac{266}{\quad} \text{ ft}$      |
| 6-3. If L is too long for the site, proceed to step 5 to adjust the swale layout |   |

Site constraints only allow a swale length of 200 feet. Reduce the target residence time or proceed to Step 4 to adjust the swale cross-sectional area, A, to shorten the swale length.

**Step 7: Adjust Swale Layout to Fit Within Site Constraints**

To adjust swale length to 200 feet, the bottom width needs to be increased (up to a maximum of 16 ft).

| <b>Step 7: Adjust swale layout to fit within site constraints</b>  |            |                     |
|--|------------|---------------------|
| 7-1. Choose a reduced swale length, $L_f$  | $L_f =$    | 250 ft              |
| 7-2. Recalculate flow velocity, $v_{wq} = L_f / (t_{HR} \bullet 60)$   | $v_{wq} =$ | 0.42 ft/s           |
| 7-3. Recalculate cross-sectional area, $A_{wq} = Q_{wq} / v_{wq}$  | $A_{wq} =$ | 3.5 ft <sup>2</sup> |
| 7-4. Calculate an increased bottom width, $b_f = (A_{wq} - Zy^2) / y$  | $b_f =$    | 9.6 ft              |
| 7-5. Recalculate longitudinal slope assuming a rectangular channel shape, $s_f = [Q_{wq} n_{wq} / (1.49 A_{wq} y^{0.67})]^2$                                   | $s_f =$    | 0.016 ft/ft         |
| 7-6. If $s_f$ is between 1.5% and 6%, the swale design is acceptable for water quality, proceed to Step 6  |            |                     |
| 7-7. If $s_f$ is between 1% and 1.5%, the swale design is acceptable for water quality with underdrains (see design requirements). Proceed to Step 6.          |            |                     |
| 7-8. If $s_f$ is <1%, the swale design is unacceptable. Consider subdividing drainage area and repeat all above steps, or choose a different BMP for the site. |            |                     |

Since width > 10 feet, the swale design is acceptable if a swale divider is included.

**Step 8: Provide Conveyance Capacity for Flows Higher than  $Q_{wq}$**

The swale will be offline such that all flows greater than  $Q_{wq}$  will be bypassed.

### Vegetated Filter Strip Worksheet

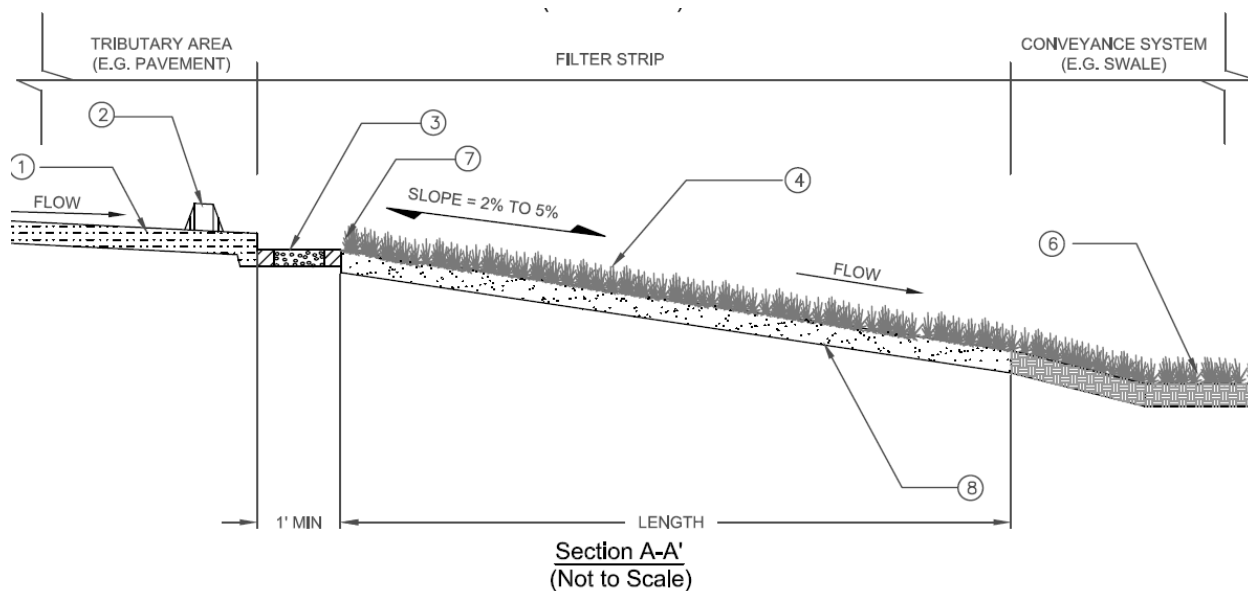

Figure D-3: Vegetated filter strip cross-section

Refer to Figure D-3 and Figure 6-8 for the description of the geometric variables.

| Step 1: Calculate the design flow  |                  |       |
|--|------------------|-------|
| 1-1. Enter drainage area, A  | A = _____        | acres |
| 1-2. Enter impervious fraction, Imp  | Imp = _____      |       |
| 1-3. Calculate runoff coefficient, $C = (0.9 \cdot \text{Imp} + 0.05)$   | C = _____        |       |
| 1-4. Calculate the water quality design flow rate, $Q_{wq}$ , based on a constant rainfall intensity of 0.25 in/hr, Appendix C | $Q_{wq} =$ _____ | cfs   |

| <b>Step 2: Calculate the design flow depth</b>  |                       |
|---|-----------------------|
| 2-1. Enter strip filter slope (in direction of flow), s   | s = _____             |
| 2-2. Enter Manning roughness coefficient (0.25-.3), $n_{wq}$  | $n_{wq}$ = _____      |
| 2-3. Enter width of impervious surface contributing area, W   | W = _____ ft          |
| 2-4. Calculate average depth of water using Manning eq, $d_f = \frac{12[Q_{wq}n_{wq}/1.49Ws^{0.5}]^{0.6}}{}$                  | $d_f$ = _____ in      |
| 2-5. If $d_f > 1"$ , go Step 2-1 and decrease the slope   |                       |
| 2-6. If the slope cannot be changed due to construction constraints, go Step 2-3 and increase the width perpendicular to flow |                       |
| 2-7. If $d_f > 1"$ and neither the slope nor the width can be changed adequately, choose an alternate BMP for the site        |                       |
| <b>Step 3: Calculate the design velocity</b>  |                       |
| 3-1. Calculate design flow velocity, $V_{wq} = Q_{wq}/d_fW$   | $V_{wq}$ = _____ ft/s |
| 3-2. If the design flow velocity is higher than 1ft/s go to step 2-1 and decrease the slope                                   |                       |
| <b>Step 4: Calculate the length of the filter strip</b>   |                       |
| 4-1. Enter residence time (10 minutes, min.), t   | t = _____ min         |
| 4-2. Calculate length of the filter strip, $L = 60tV_{wq}$  | L = _____ ft          |
| 4-3. If $L < 4$ ft (pre-treatment) or less $L < 15$ ft (treatment), go to step 2-1 and increase the slope                     |                       |

## Vegetated Filter Strip Design Example

### Step 1: Calculate the Design Flow

For this design example, a 10-acre residential development with a 60% total impervious area is considered. Flow-based sizing, as described in Appendix C, is assumed. Therefore, the design rainfall intensity is assumed to be 0.25 in/hr.

| Step 1: Calculate the design flow  |            |          |
|--|------------|----------|
| 1-1. Enter drainage area, A  | A =        | 10 acres |
| 1-2. Enter impervious fraction, Imp  | Imp =      | 0.60     |
| 1-3. Calculate runoff coefficient, $C = (0.9 \cdot \text{Imp} + 0.05)$   | C =        | 0.59     |
| 1-4. Calculate the water quality design flow rate, $Q_{wq}$ , based on a constant rainfall intensity of 0.25 in/hr, Appendix C | $Q_{wq} =$ | 1.48 cfs |

### Step 2: Calculate the Design Flow Depth

Based on the site constraints we choose the width of the filter strip 150 ft and the filter strip longitudinal slope as 3%. The design water depth should not exceed 1 inch.

| Step 2: Calculate the design flow depth   |            |         |
|---|------------|---------|
| 2-1. Enter strip filter slope (in direction of flow), s   | s =        | 0.03    |
| 2-2. Enter Manning roughness coefficient (0.25-.3), $n_{wq}$  | $n_{wq} =$ | 0.27    |
| 2-3. Enter width of impervious surface contributing area, W   | W =        | 150 ft  |
| 2-4. Calculate average depth of water using Manning eq, $d_f = 12[Q_{wq}n_{wq}/1.49Ws^{0.5}]^{0.6}$                           | $d_f =$    | 0.77 in |
| 2-5. If $d_f > 1"$ , go Step 2-1 and decrease the slope   |            |         |
| 2-6. If the slope cannot be changed due to construction constraints, go Step 2-3 and increase the width perpendicular to flow |            |         |
| 2-7. If $d_f > 1"$ and neither the slope nor the width can be changed adequately, choose an alternate BMP for the site        |            |         |

**Step 3: Calculate the Design Velocity**

The designed flow velocity should not exceed 1 foot/second across the filter strip.

| Step 3: Calculate the design velocity   |  |
|---|--|
| 3-1. Calculate design flow velocity, $V_{wq} = Q_{wq}/d_f W$                                | $V_{wq} = \underline{\quad 0.1532 \quad}$ ft/s |
| 3-2. If the design flow velocity is higher than 1ft/s go to step 2-1 and decrease the slope |  |

**Step 4: Calculate the Length of the Filter Strip**

The filter strip should be at least 4 feet long (in the direction of flow) and accommodate a minimum residence time of 10 minutes to provide adequate water quality treatment.

| Step 4: Calculate the length of the filter strip  |                    |
|---|--------------------|
| 4-1. Enter residence time (10 minutes, min.), t   | t = <u>10</u> min  |
| 4-2. Calculate length of the filter strip, $L = 60tV_{wq}$  | L = <u>91.9</u> ft |
| 4-3. If $L < 4$ ft (pre-treatment) or less $L < 15$ ft (treatment), go to step 2-1 and increase the slope |                    |

Sand Filter Worksheet

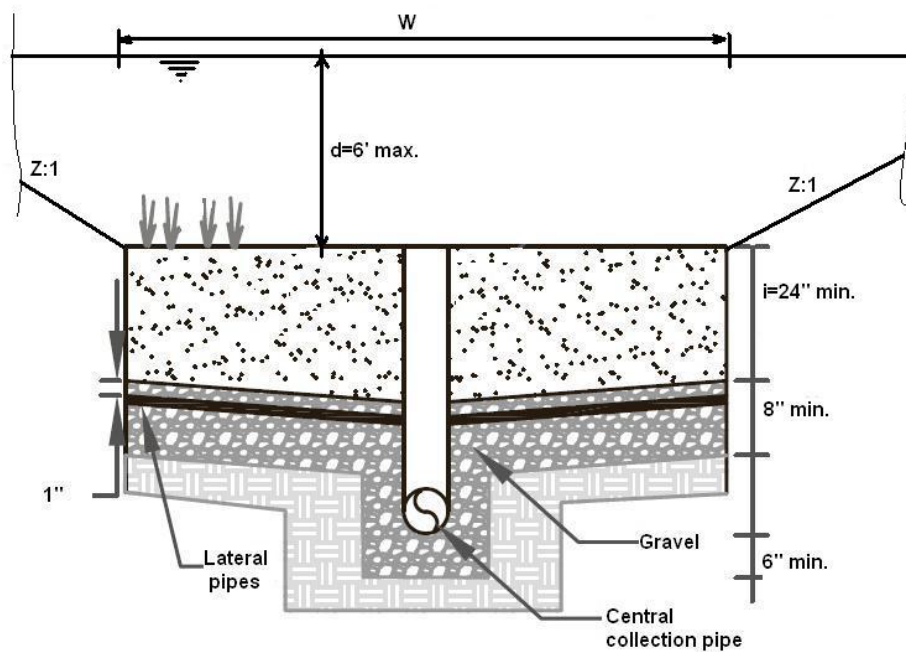

Figure D-4: Sand filter cross-section

Refer to Figure D-4 and Figure 6-10 for a diagrammatic description of the geometric variables.

| <b>Step 1: Determine storm water quality design volume, <math>V_{wq}</math></b>   |  |
|---|--|
| 1-1. Determine the water quality design volume, $V_{wq}$ , using SBUH method, Appendix C ( <u>Note</u> : $V_{wq}$ is always equal to $V_{one-inch}$ ) | $V_{wq} = \underline{\quad 25,700 \quad} \text{ ft}^3$ |

| <b>Step 2: Calculate sand filter area</b>   |             |                          |
|---|-------------|--------------------------|
| 2-1. Enter thickness of sand filter (min. 24" or 2'), $l$   | $l =$       | 2 ft                     |
| 2-2. Enter maximum storage depth (6 feet) above the filter, $d$   | $d =$       | 6 ft                     |
| 2-3. Enter routing adjustment factor, $R$   | $R =$       | 0.7                      |
| 2-4. Calculate average depth of water above the filter, $h = d/2$   | $h =$       | 3 ft                     |
| 2-5. Enter hydraulic conductivity (1"/hr), $K_i$  | $K_i =$     | 1 in/hr                  |
| 2-6. Calculate hydraulic conductivity (ft/day), $K_{day} = 2K_i$  | $K_{day} =$ | 2 ft/day                 |
| 2-7. Calculate hydraulic gradient, $i = (h+l)/l$  | $i =$       | 2.5 ft/ft                |
| 2-8. Enter drawdown time, $t$   | $t =$       | 2 day                    |
| 2-9. Calculate sand filter area, $A_{sf} = (V_{wq}RI)/(K_{day}t(h+l))$  | $A_{sf} =$  | 1,799 ft <sup>2</sup>    |
| <b>Step 3: Determine filter dimensions</b>  |             |                          |
| 3-1. Sand filter area, $A_{sf}$   | $A_{sf} =$  | 1,799 ft <sup>2</sup>    |
| 3-2. Enter geometric configuration, $L_R:W$ ratio (2:1), $L_R$  | $L_R =$     | 2                        |
| 3-3. Calculate the width of the sand filter, $W$  | $W =$       | 30.0 ft                  |
| 3-4. Calculate the length of the sand filter, $L$   | $L =$       | 60.0 ft                  |
| 3-5. Calculate rate of filtration, $r_{wq} = K_{day}i$  | $r_{wq} =$  | 5.0 ft/d/ft <sup>2</sup> |
| <b>Step 4: Calculate storage volume</b>   |             |                          |
| 4-1. Enter interior side slopes, 3H:1V (max), $Z$   | $Z =$       | 3                        |
| 4-2. Calculate top length, $L_t = L + 2Zd$  | $L_t =$     | 96.0 ft                  |
| 4-3. Calculate top width, $W_t = W + 2Zd$   | $W_t =$     | 66.0 ft                  |
| 4-4. Calculate filter storage volume, $V_s = 1/3 \cdot d(A_{sf} + A_t + (A_{sf}A_t)^{0.5})$ where $A_t = L_t \cdot W_t$ | $V_s =$     | 23,018 ft <sup>3</sup>   |



| Step 5: Calculate underdrain system  |             |                 |
|--|-------------|-----------------|
| 5-1. Calculated filtered flow rate, $Q_f = (r_{wq}A_{sf})/86400$   | $Q_f =$     | <u>0.10</u> cfs |
| 5-2. Enter minimum slope for energy gradient, $S_e$  | $S_e =$     | <u>0.005</u>    |
| 5-3. Enter Hazen-Williams coefficient for plastic, $C$   | $C =$       | <u>140</u>      |
| 5-4. Enter pipe diameter, $D$  | $D =$       | <u>6</u> in     |
| 5-5. Calculate pipe hydraulic radius, $R_h = D/48$   | $R_h =$     | <u>0.13</u>     |
| 5-6. Calculate velocity at the outlet of the pipe, $V_p = 1.318CR_h^{0.63}S_e^{0.54}$  | $V_p =$     | <u>2.8</u> ft/s |
| 5-7. Calculate pipe capacity, $Q_{cap} = 0.25\pi(D/12)^2V_p$   | $Q_{cap} =$ | <u>0.6</u> cfs  |
| Step 6: Provide conveyance capacity for filter clogging  |             |                 |
| 6-1. The sand filters should be placed off-line, but an emergency overflow must still be provided in the event the filter becomes clogged and <b>verify that all parameters meet design requirements</b> to complete sizing. |             |                 |

### Sand Filter Design Example

#### Step 1: Calculate the Design Flow

For this design example, a 10-acre residential development with a 60% total impervious area is considered. Flow-based sizing, as described in Appendix C, is assumed. Therefore, the design rainfall intensity is assumed to be 0.25 in/hr.

| Step 1: Calculate the design flow  |            |          |
|--|------------|----------|
| 1-1. Enter drainage area, A  | A =        | 10 acres |
| 1-2. Enter impervious fraction, Imp  | Imp =      | 0.60     |
| 1-3. Calculate runoff coefficient, $C = (0.9 \cdot \text{Imp} + 0.05)$   | C =        | 0.59     |
| 1-4. Calculate the water quality design flow rate, $Q_{wq}$ , based on a constant rainfall intensity of 0.25 in/hr, Appendix C | $Q_{wq}$ = | 1.48 cfs |

**Step 2: Calculate Sand Filter Area**

A sand filter is designed with two components: (1) temporary storage reservoir to store runoff, and (2) a sand filter bed through which the stored runoff must percolate getting treatment.

The simple sizing method does not route flows through the filter. The size of the filter is determined based on the simple assumption that inflow is immediately discharged through the filter. The adjustment factor, R, is applied to compensate for the greater filter size resulting from this method.

| Step 2: Calculate sand filter area                                     |             |       |                 |
|--|-------------|-------|-----------------|
| 2-1. Enter thickness of sand filter (min. 24" or 2'), l                | l =         | 2     | ft              |
| 2-2. Enter maximum storage depth (6 feet) above the filter, d          | d =         | 6     | ft              |
| 2-3. Enter routing adjustment factor, R                                | R =         | 0.7   |                 |
| 2-4. Calculate average depth of water above the filter, $h = d/2$      | h =         | 3     | ft              |
| 2-5. Enter hydraulic conductivity (1"/hr), $K_i$                       | $K_i =$     | 1     | in/hr           |
| 2-6. Calculate hydraulic conductivity (ft/day), $K_{day} = 2K_i$       | $K_{day} =$ | 2     | ft/day          |
| 2-7. Calculate hydraulic gradient, $i = (h+l)/l$                       | i =         | 2.5   | ft/ft           |
| 2-8. Enter drawdown time, t  | t =         | 2     | day             |
| 2-9. Calculate sand filter area, $A_{sf} = (V_{wq}RI)/(K_{day}t(h+l))$ | $A_{sf} =$  | 1,799 | ft <sup>2</sup> |

**Step 3: Determine Filter Dimensions**

| Step 3: Determine filter dimensions                            |            |                        |
|--|------------|------------------------|
| 3-1. Sand filter area, $A_{sf}$                                | $A_{sf} =$ | <u>1,799</u> $ft^2$    |
| 3-2. Enter geometric configuration, $L_R:W$ ratio (2:1), $L_R$ | $L_R =$    | <u>2</u>               |
| 3-3. Calculate the width of the sand filter, $W$               | $W =$      | <u>30.0</u> $ft$       |
| 3-4. Calculate the length of the sand filter, $L$              | $L =$      | <u>60.0</u> $ft$       |
| 3-5. Calculate rate of filtration, $r_{wq} = K_{day}i$         | $r_{wq} =$ | <u>5.0</u> $ft/d/ft^2$ |

**Step 4: Calculate Storage Volume**

The side slopes are will be designed as 3H:1V, so  $Z = 3$ .

| Step 4: Calculate storage volume  |         |                      |
|---|---------|----------------------|
| 4-1. Enter interior side slopes, 3H:1V (max), $Z$   | $Z =$   | <u>3</u>             |
| 4-2. Calculate top length, $L_t = L + 2Zd$  | $L_t =$ | <u>96.0</u> $ft$     |
| 4-3. Calculate top width, $W_t = W + 2Zd$   | $W_t =$ | <u>66.0</u> $ft$     |
| 4-4. Calculate filter storage volume, $V_s = 1/3 \cdot d(A_{sf} + A_t + (A_{sf}A_t)^{0.5})$ where $A_t = L_t \cdot W_t$ | $V_s =$ | <u>23,018</u> $ft^3$ |

### Step 5: Calculate Underdrain System

All underdrain pipes must be 6 inches or greater to facilitate cleaning.

| Step 5: Calculate underdrain system   |             |       |      |
|---|-------------|-------|------|
| 5-1. Calculated filtered flow rate, $Q_f = (r_{wq}A_{sf})/86400$                      | $Q_f =$     | 0.10  | cfs  |
| 5-2. Enter minimum slope for energy gradient, $S_e$                                   | $S_e =$     | 0.005 |      |
| 5-3. Enter Hazen-Williams coefficient for plastic, C                                  | C =         | 140   |      |
| 5-4. Enter pipe diameter, D   | D =         | 6     | in   |
| 5-5. Calculate pipe hydraulic radius, $R_h = D/48$                                    | $R_h =$     | 0.13  |      |
| 5-6. Calculate velocity at the outlet of the pipe, $V_p = 1.318CR_h^{0.63}S_e^{0.54}$ | $V_p =$     | 2.8   | ft/s |
| 5-7. Calculate pipe capacity, $Q_{cap} = 0.25\pi(D/12)^2V_p$                          | $Q_{cap} =$ | 0.6   | cfs  |

### Step 6: Provide Conveyance Capacity for Filter Clogging

The sand filters should be placed off-line, but an emergency overflow must still be provided in the event the filter becomes clogged and **verify that all parameters meet design requirements** to complete sizing.

**Infiltration BMP Worksheet**

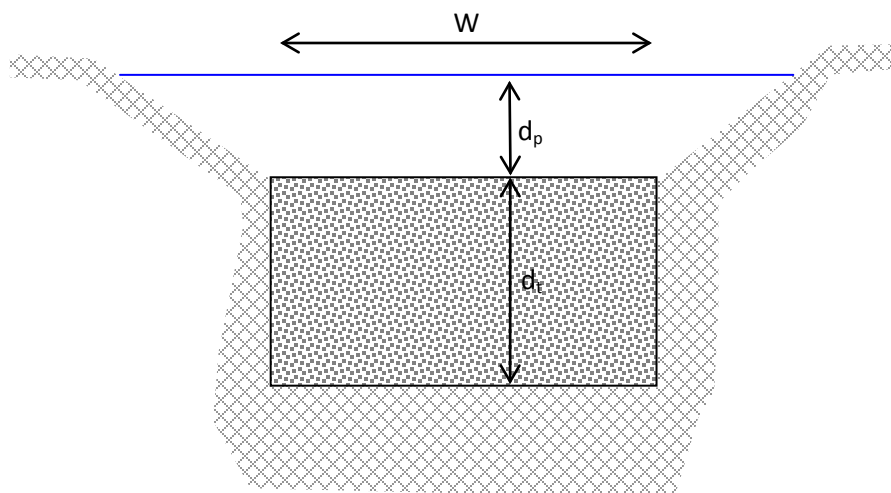

Figure D-5: Infiltration BMP cross-section

Refer to Figures D-5, 6-12, 6-13 and 6-14 for a diagrammatic description of the geometric variables.

| <b>Step 1: Determine design volume reduction, <math>V_{\text{reduction}}</math></b>  |  |
|--|--|
| 1-1. Enter the volume difference between the pre- and post-development conditions for the 25-yr, 24-hr design storm, $V_{25}$ , calculated using SBUH method, Appendix C   | $V_{25} =$ _____ $\text{ft}^3$               |
| 1-2. Enter the volume generated from a one-inch, 24-hr storm event, $V_{\text{one-inch}}$ , calculated using SBUH method, Appendix C                                       | $V_{\text{one-inch}} =$ _____ $\text{ft}^3$  |
| 1-3. Determine design volume reduction which is the larger of $V_{25}$ and $V_{\text{one-inch}}$ and is the volume to be retained on-site                                  | $V_{\text{reduction}} =$ _____ $\text{ft}^3$ |
| <b>Step 2: Determine storm water quality design volume, <math>V_{\text{wq}}</math></b>   |  |
| 2-1. Determine the water quality design volume, $V_{\text{wq}}$ , using SBUH method, Appendix C ( <u>Note</u> : $V_{\text{wq}}$ is always equal to $V_{\text{one-inch}}$ ) | $V_{\text{wq}} =$ _____ $\text{ft}^3$        |
| <b>Step 3: Determine design volume, <math>V_{\text{design}}</math> (for sizing)</b>  |  |
| 3-1. $V_{\text{design}} =$ the larger of $V_{\text{reduction}}$ and $V_{\text{wq}}$  | $V_{\text{design}} =$ _____ $\text{ft}^3$    |

| <b>Step 4: Calculate design infiltration rate</b>   |   |
|---|---|
| 4-1. Enter soil infiltration rate (0.5 in/hr min.), $k_{\text{measured}}$   | $k_{\text{measured}} =$ _____ in/hr     |
| 4-2. Enter correction factor for testing (0.3 small scale, 0.5 large scale), $F_t$  | $F_t =$ _____ ft                        |
| 4-3. Enter correction factor for plugging, (0.7 loams-sandy loams, 0.8 fine-loamy sands, 0.9 medium sands, 1.0 coarse sands-cobbles, $F_p$          | $F_p =$ _____                           |
| 4-4. Enter the depth from the bottom of the facility to the maximum wet-season water table or nearest impervious layer, whichever is less. D        | D = _____ ft                            |
| 4-5. Enter the estimated width of the facility  | W = _____ ft                            |
| 4-6. Calculate the correction factor of geometry (0.25 min, 1.0 max), $F_g = 4 \cdot D/W + 0.05$  | $F_g =$ _____                           |
| 4-7. Calculate the design infiltration rate, $k_{\text{design}} = k_{\text{measured}} F_t F_p F_g$  | $k_{\text{design}} =$ _____ in/hr       |
| <b>Step 5: Determine facility size</b>  |   |
| 5-1. Enter drawdown time(72 hrs max.), $t_d$  | $t_d =$ _____ hrs                       |
| 5-2. Calculate max.depth of runoff that can be infiltrated within the $t_d$ ,<br>$d_{\text{max}} = k_{\text{design}} t_d / 12$                      | $d_{\text{max}} =$ _____ ft             |
| 5-3. Enter trench fill aggregate porosity, $n_t$  | $n_t =$ _____                           |
| 5-4. Enter depth of trench fill, $d_t$  | $d_t =$ _____ in                        |
| 5-5. Enter max ponding depth, or max. $d_p = d_{\text{max}} - n_t d_t$  | $d_p =$ _____ ft                        |
| <b>Step 6: Determine infiltrating surface area (filter bottom area)</b>   |   |
| 6-1. Enter the time to fill infiltration basin or trench with water (Use 2 hours for most designs), T   | T = _____ hrs                           |
| 6-2. Calculate infiltrating surface area for infiltration basin:<br>$A_b = V_{\text{design}} / ((T k_{\text{design}} / 12) + d_p)$                  | $A_b =$ _____ ft <sup>2</sup>           |
| 6-3. Calculate infiltrating surface area for infiltration trenches:<br>$A_t = V_{\text{design}} / ((T k_{\text{design}} / 12) + n_t d_t + d_p)$     | $A_t =$ _____ ft <sup>2</sup>           |
| 6-4. Calculate infiltrating surface area for dry wells:<br>$A_{\text{dw}} = V_{\text{design}} / ((T k_{\text{design}} / 12) + n_t d_t)$             | $A_{\text{dw}} =$ _____ ft <sup>3</sup> |
| <b>Step 7: Provide conveyance capacity for filter clogging</b>  |   |
| 7-1. The infiltration facility should be placed off-line, but an emergency overflow must still be provided in the event the filter becomes clogged. |   |

## Infiltration BMP Design Example

### Step 1: Determine Storm Water Quality Design Volume Reduction, $V_{\text{reduction}}$

| Step 1: Determine design volume reduction, $V_{\text{reduction}}$  |   |
|--|---|
| 1-1. Enter the volume difference between the pre- and post-development conditions for the 25-yr, 24-hr design storm, $V_{25}$ , calculated using SBUH method, Appendix C | $V_{25} = \underline{\quad 20 \quad} \text{ft}^3$                   |
| 1-2. Enter the volume generated from a one-inch, 24-hr storm event, $V_{\text{one-inch}}$ , calculated using SBUH method, Appendix C                                     | $V_{\text{one-inch}} = \underline{\quad 25,700 \quad} \text{ft}^3$  |
| 1-3. Determine design volume reduction which is the larger of $V_{25}$ and $V_{\text{one-inch}}$ and is the volume to be retained on-site                                | $V_{\text{reduction}} = \underline{\quad 25,700 \quad} \text{ft}^3$ |

### Step 2: Determine Storm Water Quality Design Volume, $V_{\text{wq}}$

| Step 2: Determine storm water quality design volume, $V_{\text{wq}}$   |  |
|--|--|
| 2-1. Determine the water quality design volume, $V_{\text{wq}}$ , using SBUH method, Appendix C ( <u>Note</u> : $V_{\text{wq}}$ is always equal to $V_{\text{one-inch}}$ ) | $V_{\text{wq}} = \underline{\quad 25,700 \quad} \text{ft}^3$ |

### Step 3: Determine Design Volume, $V_{\text{design}}$

| Step 3: Determine design volume, $V_{\text{design}}$ (for sizing)                   |  |
|---|--|
| 3-1. $V_{\text{design}} =$ the larger of $V_{\text{reduction}}$ and $V_{\text{wq}}$ | $V_{\text{design}} = \underline{\quad 25,700 \quad} \text{ft}^3$ |



**Step 4: Calculate Design Infiltration Rate**

Infiltration facilities require a minimum soil infiltration rate of 0.5 in/hr. If the rate exceeds 2.4 in/hr, then the runoff should be fully treated in an upstream BMP prior to infiltration to protect the groundwater quality.

The factors applied to in-situ measured infiltration rate take into account uncertainty in measures, depth of water, geometry and long term reductions in permeability due to biofouling and fines accumulation. A small scale testing factor has been assigned to this example. Since the soils in the residential development have been designated as loamy sands, a plugging factor of 0.8 should be used. If the depth from the bottom of the site to the maximum water table is 10 ft and there is space to create the infiltration facility at roughly 60 ft wide, then the correction factor of geometry can be calculated as 0.72.

| Step 4: Calculate design infiltration rate   |                         |            |
|--|-------------------------|------------|
| 4-1. Enter soil infiltration rate (0.5 in/hr min.), $k_{\text{measured}}$  | $k_{\text{measured}} =$ | 4 in/hr    |
| 4-2. Enter correction factor for testing (0.3 small scale, 0.5 large scale), $F_t$   | $F_t =$                 | 0.3        |
| 4-3. Enter correction factor for plugging, (0.7 loams-sandy loams, 0.8 fine-loamy sands, 0.9 medium sands, 1.0 coarse sands-cobbles, $F_p$   | $F_p =$                 | 0.8        |
| 4-4. Enter the depth from the bottom of the facility to the maximum wet-season water table or nearest impervious layer, whichever is less. D | D =                     | 10 ft      |
| 4-5. Enter the estimated width of the facility   | W =                     | 60 ft      |
| 4-6. Calculate the correction factor of geometry (0.25 min, 1.0 max), $F_g = 4 \cdot D/W + 0.05$   | $F_g =$                 | 0.72       |
| 4-7. Calculate the design infiltration rate, $k_{\text{design}} = k_{\text{measured}} F_t F_p F_g$   | $k_{\text{design}} =$   | 0.69 in/hr |

**Step 5: Determine Facility Size**

The simple sizing method requires that the water quality volume must be completely infiltrated within 72 hours. The size of the filter is determined based on the simple assumption that inflow is immediately discharged through the filter.

| Step 5: Determine facility size   |             |      |     |
|---|-------------|------|-----|
| 5-1. Enter drawdown time(72 hrs max.), $t_d$  | $t_d =$     | 72   | hrs |
| 5-2. Calculate max.depth of runoff that can be infiltrated within the $t_d$ ,<br>$d_{max}=k_{design}t_d/12$ | $d_{max} =$ | 4.13 | ft  |
| 5-3. Enter trench fill aggregate porosity, $n_t$  | $n_t =$     | 0.35 |     |
| 5-4. Enter depth of trench fill, $d_t$  | $d_t =$     | 48   | in  |
| 5-5. Enter max ponding depth, or max. $d_p=d_{max}-n_t d_t$   | $d_p =$     | 2.73 | ft  |

**Step 6: Determine Infiltrating Surface Area**

The size of the infiltrating surface is determined by assuming the water quality design volume will fill the available ponding depth plus the void spaces of the computed porosity (usually about 32%) of the filter media.

| Step 6: Determine infiltrating surface area (filter bottom area)   |            |       |                 |
|--|------------|-------|-----------------|
| 6-1. Enter the time to fill infiltration basin or trench with water (Use 2 hours for most designs), T                  | T =        | 2     | hrs             |
| 6-2. Calculate infiltrating surface area for infiltration basin:<br>$A_b=V_{design}/((Tk_{design}/12)+d_p)$            | $A_b =$    | 9,041 | ft <sup>2</sup> |
| 6-3. Calculate infiltrating surface area for infiltration trenches:<br>$A_t=V_{design}/((Tk_{design}/12)+n_t d_t+d_p)$ | $A_t =$    | 1,308 | ft <sup>2</sup> |
| 6-4. Calculate infiltrating surface area for dry wells:<br>$A_{dw}=V_{design}/((Tk_{design}/12)+n_t d_t)$              | $A_{dw} =$ | 1,519 | ft <sup>3</sup> |

**Step 7: Provide Conveyance Capacity for Flows Higher than  $Q_{wq}$**

The infiltration facility should be placed off-line, but an emergency overflow for flows greater than the water quality peak flow rate,  $Q_{wq}$ , must still be provided in the event the filter becomes clogged.

Permeable Pavement Worksheet

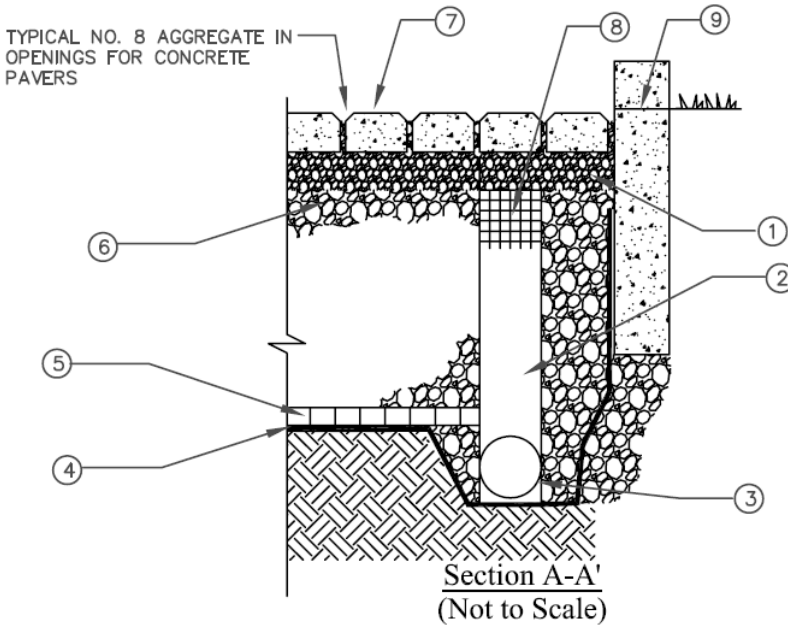

Figure D-6: Permeable Pavement cross-section

Refer to Figures D-6 and Figure 6-16 for a diagrammatic description of the geometric variables.

| <b>Step 1: Determine design volume reduction, <math>V_{reduction}</math></b>   |   |
|--|---|
| 1-1. Enter the volume difference between the pre- and post-development conditions for the 25-yr, 24-hr design storm, $V_{25}$ , calculated using SBUH method, Appendix C | $V_{25} = \underline{\quad 32,000 \quad} \text{ ft}^3$        |
| 1-2. Enter the volume generated from a one-inch, 24-hr storm event, $V_{one-inch}$ , calculated using SBUH method, Appendix C  | $V_{one-inch} = \underline{\quad 25,700 \quad} \text{ ft}^3$  |
| 1-3. Determine design volume reduction which is the larger of $V_{25}$ and $V_{one-inch}$ and is the volume to be retained on-site                                       | $V_{reduction} = \underline{\quad 32,000 \quad} \text{ ft}^3$ |
| <b>Step 2: Determine storm water quality design volume, <math>V_{wq}</math></b>  |   |
| 2-1. Determine the water quality design volume, $V_{wq}$ , using SBUH method, Appendix C ( <u>Note</u> : $V_{wq}$ is always equal to $V_{one-inch}$ )                    | $V_{wq} = \underline{\quad 25,700 \quad} \text{ ft}^3$        |

| <b>Step 3: Determine design volume, <math>V_{\text{design}}</math> (for sizing)</b>  |   |
|--|---|
| 3-1. If no infiltration (i.e., impermeable liner w/ underdrains), $V_{\text{design}} = V_{\text{wq}}$ .  | $V_{\text{design}} = \underline{\quad 25,700 \quad} \text{ ft}^3$ |
| 3-2. If partial infiltration (i.e., permeable liner w/underdrains), $V_{\text{design}} = V_{\text{wq}} + 0.2V_{\text{wq}}$                     | $V_{\text{design}} = \underline{\quad 30,840 \quad} \text{ ft}^3$ |
| 3-3. If full infiltration (i.e., permeable liner w/ no underdrains), $V_{\text{design}} = V_{\text{reduction}}$                                | $V_{\text{design}} = \underline{\quad 32,000 \quad} \text{ ft}^3$ |
| <b>Step 4: Calculate design infiltration rate (assume full infiltration, <math>V_{\text{design}} = V_{\text{reduction}}</math>)</b>            |   |
| 4-1. Enter soil infiltration rate (0.5 in/hr min.), $k_{\text{measured}}$  | $k_{\text{measured}} = \underline{\quad 3 \quad} \text{ in/hr}$   |
| 4-2. Enter correction factor for testing (0.3 small scale, 0.5 large scale), $F_t$   | $F_t = \underline{\quad 0.3 \quad} \text{ ft}$                    |
| 4-3. Enter correction factor for plugging, (0.7 loams-sandy loams, 0.8 fine-loamy sands, 0.9 medium sands, 1.0 coarse sands-cobbles, $F_p$     | $F_p = \underline{\quad 0.8 \quad}$                               |
| 4-4. Enter the depth from the bottom of the facility to the maximum wet-season water table or nearest impervious layer, whichever is less. $D$ | $D = \underline{\quad 10 \quad} \text{ ft}$                       |
| 4-5. Enter the estimated width of the facility   | $W = \underline{\quad 60 \quad} \text{ ft}$                       |
| 4-6. Calculate the correction factor of geometry (0.25 min, 1.0 max), $F_g = 4 \cdot D/W + 0.05$   | $F_g = \underline{\quad 0.72 \quad}$                              |
| 4-7. Calculate the design infiltration rate, $k_{\text{design}} = k_{\text{measured}} F_t F_p F_g$   | $k_{\text{design}} = \underline{\quad 0.52 \quad} \text{ in/hr}$  |
| <b>Step 5: Determine maximum depth that can be infiltrated</b>   |   |
| 5-1. Enter drawdown time (72 hrs max.), $t$  | $t = \underline{\quad 72 \quad} \text{ hrs}$                      |
| 5-2. Calculate max.depth of runoff that can be infiltrated within the $t$ , $d_{\text{max}} = k_{\text{design}} t / 12$                        | $d_{\text{max}} = \underline{\quad 3.10 \quad} \text{ ft}$        |
| <b>Step 6: Determine infiltrating surface area (gravel drainage area)</b>  |   |
| 6-1. Enter gravel drainage layer porosity, $n$   | $n = \underline{\quad 0.32 \quad}$                                |
| 6-2. Enter depth of gravel drainage layer, $l$   | $l = \underline{\quad 48.00 \quad} \text{ in}$                    |
| 6-3. Enter the time to fill the gravel drainage layer with water (Use 2 hours for most designs), $T$   | $T = \underline{\quad 2 \quad} \text{ hrs}$                       |
| 6-4. Calculate infiltrating surface area for dry wells:<br>$A = V_{\text{design}} / (Tk_{\text{design}}/12 + n \cdot l)$                       | $A = \underline{\quad 2,072 \quad} \text{ ft}^3$                  |

**Step 7: Provide conveyance capacity for filter clogging**

7-1. The permeable pavement must have an emergency overflow for storm events greater than the design and in the event the permeable pavement becomes clogged.

## Permeable Pavement Design Example

### Step 1: Determine Storm Water Quality Design Volume Reduction, $V_{\text{reduction}}$

| Step 1: Determine design volume reduction, $V_{\text{reduction}}$  |   |
|--|---|
| 1-1. Enter the volume difference between the pre- and post-development conditions for the 25-yr, 24-hr design storm, $V_{25}$ , calculated using SBUH method, Appendix C | $V_{25} = \underline{\quad 20 \quad} \text{ft}^3$                   |
| 1-2. Enter the volume generated from a one-inch, 24-hr storm event, $V_{\text{one-inch}}$ , calculated using SBUH method, Appendix C                                     | $V_{\text{one-inch}} = \underline{\quad 25,700 \quad} \text{ft}^3$  |
| 1-3. Determine design volume reduction which is the larger of $V_{25}$ and $V_{\text{one-inch}}$ and is the volume to be retained on-site                                | $V_{\text{reduction}} = \underline{\quad 25,700 \quad} \text{ft}^3$ |

### Step 2: Determine Storm Water Quality Design Volume, $V_{\text{wq}}$

| Step 2: Determine storm water quality design volume, $V_{\text{wq}}$   |  |
|--|--|
| 2-1. Determine the water quality design volume, $V_{\text{wq}}$ , using SBUH method, Appendix C ( <u>Note</u> : $V_{\text{wq}}$ is always equal to $V_{\text{one-inch}}$ ) | $V_{\text{wq}} = \underline{\quad 25,700 \quad} \text{ft}^3$ |

### Step 3: Determine Design Volume, $V_{\text{design}}$

| Step 3: Determine design volume, $V_{\text{design}}$ (for sizing)  |  |
|--|--|
| 3-1. If no infiltration (i.e., impermeable liner w/ underdrains), $V_{\text{design}} = V_{\text{wq}}$ .                    | $V_{\text{design}} = \underline{\hspace{2cm}} \text{ft}^3$ |
| 3-2. If partial infiltration (i.e., permeable liner w/underdrains), $V_{\text{design}} = V_{\text{wq}} + 0.2V_{\text{wq}}$ | $V_{\text{design}} = \underline{\hspace{2cm}} \text{ft}^3$ |
| 3-3. If full infiltration (i.e., permeable liner w/ no underdrains), $V_{\text{design}} = V_{\text{reduction}}$            | $V_{\text{design}} = \underline{\hspace{2cm}} \text{ft}^3$ |

**Step 4: Calculate Design Infiltration Rate (assuming full infiltration)**

Permeable pavement with no underdrain requires a minimum soil infiltration rate of 0.5 in/hr.

The factors applied to in-situ measured infiltration rate take into account uncertainty in measures, depth of water, geometry and long term reductions in permeability due to biofouling and fines accumulation. A small scale testing factor has been assigned to this example. Since the soils in the residential development have been designated as loamy sands, a plugging factor of 0.8 should be used. If the depth from the bottom of the site to the maximum water table is 10 ft and there is space to create the infiltration facility at roughly 60 ft wide, then the correction factor of geometry can be calculated as 0.72.

| <b>Step 4: Calculate design infiltration rate (assume full infiltration, <math>V_{design} = V_{reduction}</math>)</b>                        |                           |
|--|---------------------------|
| 4-1. Enter soil infiltration rate (0.5 in/hr min.), $k_{measured}$   | $k_{measured} = 3$ in/hr  |
| 4-2. Enter correction factor for testing (0.3 small scale, 0.5 large scale), $F_t$   | $F_t = 0.3$ ft            |
| 4-3. Enter correction factor for plugging, (0.7 loams-sandy loams, 0.8 fine-loamy sands, 0.9 medium sands, 1.0 coarse sands-cobbles), $F_p$  | $F_p = 0.8$               |
| 4-4. Enter the depth from the bottom of the facility to the maximum wet-season water table or nearest impervious layer, whichever is less. D | $D = 10$ ft               |
| 4-5. Enter the estimated width of the facility   | $W = 60$ ft               |
| 4-6. Calculate the correction factor of geometry (0.25 min, 1.0 max), $F_g = 4 \cdot D/W + 0.05$   | $F_g = 0.72$              |
| 4-7. Calculate the design infiltration rate, $k_{design} = k_{measured} F_t F_p F_g$   | $k_{design} = 0.52$ in/hr |

**Step 5: Determine maximum depth that can be infiltrated**

| <b>Step 5: Determine maximum depth that can be infiltrated</b>   |                     |
|--|---------------------|
| 5-1. Enter drawdown time (72 hrs max.), t  | $t = 72$ hrs        |
| 5-2. Calculate max.depth of runoff that can be infiltrated within the t, $d_{max} = k_{design} t / 12$ | $d_{max} = 3.10$ ft |

**Step 6: Determine the infiltrating surface area (gravel drainage area)**

| <b>Step 6: Determine infiltrating surface area (gravel drainage area)</b>   |                           |
|---|---------------------------|
| 6-1. Enter gravel drainage layer porosity, n  | n = 0.32                  |
| 6-2. Enter depth of gravel drainage layer, l  | l = 48.00 in              |
| 6-3. Enter the time to fill the gravel drainage layer with water (Use 2 hours for most designs), T                        | T = 2 hrs                 |
| 6-4. Calculate infiltrating surface area for dry wells:<br>$A = V_{\text{design}} / ((T k_{\text{design}} / 12) + n * l)$ | A = 2,072 ft <sup>3</sup> |

**Step 7: Determine maximum depth that can be infiltrated**

| <b>Step 7: Provide conveyance capacity for filter clogging</b>  |
|---|
| 7-1. The permeable pavement must have an emergency overflow for storm events greater than the design and in the event the permeable pavement becomes clogged. |



**Constructed Treatment Wetland Worksheet**

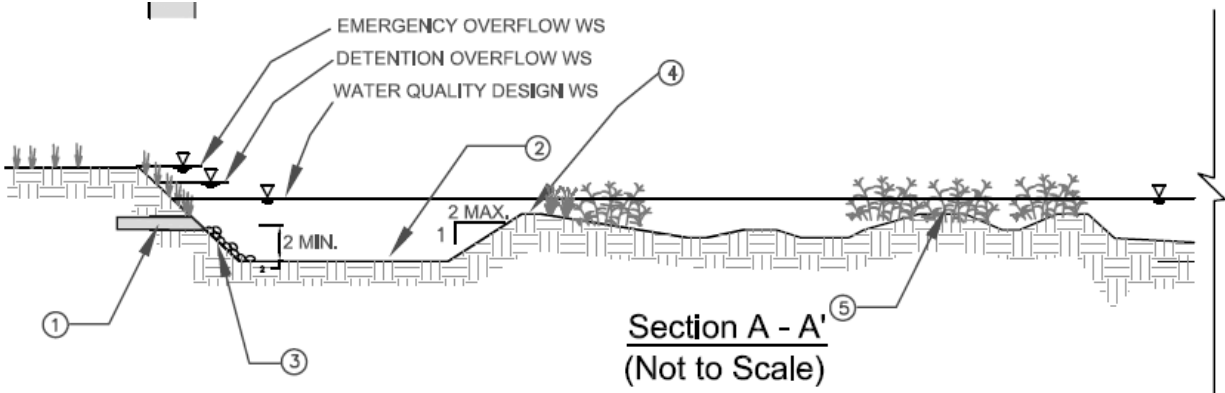

Figure D-7: Constructed treatment wetland cross-section

Refer to Figures D-7 and 6-22 for a diagrammatic description of the geometric variables.

|   |                         |
|---|-------------------------|
| <b>Step 1: Determine storm water quality design volume, <math>V_{wq}</math></b>   |                         |
| 1-1. Determine the water quality design volume, $V_{wq}$ , using SBUH method, Appendix C ( <u>Note</u> : $V_{wq}$ is always equal to $V_{one-inch}$ ) | $V_{wq} =$ _____ $ft^3$ |

**Step 2: Determine Wetland Location, Wetland Type and Preliminary Geometry Based on Site Constraints**

2-1. Based on site constraints, determine the wetland geometry and the storage available by developing an elevation-storage relationship for the wetland. For this simple example, assume a trapezoidal geometry for cell 1 (forebay) and cell 2. The wetland does not have extended detention.

2-2. Enter the total surface area of the wetland footprint based on site constraints,  $A_{tot}$

$A_{tot} =$  \_\_\_\_\_  $ft^2$

2-3. Enter the length of the wetland footprint based on site constraints,  $L_{tot}$

$L_{tot} =$  \_\_\_\_\_  $ft$

2-4. Calculate the width of the wetland footprint,  $W_{tot} = A_{tot} / L_{tot}$

$W_{tot} =$  \_\_\_\_\_  $ft$

2-5. Enter interior side slope as length per unit height (min = 3),  $Z$

$Z =$  \_\_\_\_\_

2-6. Enter desired freeboard depth,  $d_{fb}$

$d_{fb} =$  \_\_\_\_\_  $ft$

2-7. Calculate the length of the water quality surface area including the internal berm but excluding freeboard,  $L_{wq-tot} = L_{tot} - 2Zd_{fb}$

$L_{wq-tot} =$  \_\_\_\_\_  $ft$

2-8. Calculate the width of the water quality surface area including the internal berm but excluding freeboard,  $W_{wq-tot} = W_{tot} - 2Zd_{fb}$

$W_{wq-tot} =$  \_\_\_\_\_  $ft$

2-9. Calculate the total water quality surface area including the internal berm and excluding freeboard,  $A_{wq-tot} = L_{wq-tot} \cdot W_{wq-tot}$

$A_{wq-tot} =$  \_\_\_\_\_  $ft^2$

2-10. Enter the width of the internal berm (6 ft min),  $W_{berm}$

$W_{berm} =$  \_\_\_\_\_  $ft$

2-11. Enter the length of the internal berm,  $L_{berm} = W_{wq-tot}$

$L_{berm} =$  \_\_\_\_\_  $ft$

2-12. Calculate the area of the berm,  $A_{berm} = W_{berm} \cdot L_{berm}$

$A_{berm} =$  \_\_\_\_\_  $ft^2$

2-13. Calculate the active volume surface area excluding the internal berm and freeboard,  $A_{wq} = A_{wq-tot} - A_{berm}$

$A_{wq} =$  \_\_\_\_\_  $ft^2$

| Step 3: Determine Dimensions of Cell 1   |           |                     |
|--|-----------|---------------------|
| 3-1. Enter the percent of $V_{wq}$ in Cell 1 (10-20% required), $\%V_1$  | $\%V_1 =$ | _____ %             |
| 3-2. Calculate the active volume of Cell 1 (including sediment storage), $V_1 = (V_{wq} \cdot \%V_1)/100$                                    | $V_1 =$   | _____ $\text{ft}^3$ |
| 3-3. Enter desired average depth of Cell 1 (5-9 ft including sediment storage of 1 ft), $d_1$  | $d_1 =$   | _____ ft            |
| 3-4. Calculate the surface area for the water quality volume of Cell 1, $A_1 = V_1 / d_1$  | $A_1 =$   | _____ $\text{ft}^2$ |
| 3-5. Enter the width of Cell 1, $W_1 = W_{av-tot} = L_{berm}$  | $W_1 =$   | _____ ft            |
| 3-6. Calculate the length of Cell 1 ( <u>Note</u> : inlet and outlet should be configured to maximize the residence time), $L_1 = A_1 / W_1$ | $L_1 =$   | _____ ft            |

| <b>Step 4: Determine Dimensions of Cell 2</b>  |              |                       |
|--|--------------|-----------------------|
| 4-1. Calculate the active volume of Cell 2, $V_2 = V_{wq} - V_1$   | $V_2 =$      | _____ ft <sup>3</sup> |
| 4-2. Calculate surface area of Cell 2, $A_2 = A_{wq} - A_1$  | $A_2 =$      | _____ ft <sup>2</sup> |
| 4-3. Enter width of Cell 2, $W_2 = W_1 = W_{wq-tot} = L_{berm}$  | $W_2 =$      | _____ ft              |
| 4-4. Calculate top length of Cell 2, $L_2 = A_2 / W_2$   | $L_2 =$      | _____ ft              |
| 4-5. Verify that the length-to-width ratio of Cell 2 is at least 3:1 with $\geq 4:1$ preferred. If the length-to-width ratio is less than 3:1, modify input parameters until a ratio of at least 3:1 is achieved. If the input parameters cannot be modified as a result of site constraints, another site for the pond should be chosen, $LW_2 = L_2 / W_2$ | $LW_2 =$     | _____                 |
| 4-6. Enter percent of surface area of very shallow zone, % $A_{vs}$  | $\%A_{vs} =$ | _____ ft <sup>2</sup> |
| 4-7. Calculate very shallow zone surface area, $A_{vs} = (A_2 \cdot \%A_{vs})/100$   | $A_{vs} =$   | _____ ft <sup>2</sup> |
| 4-8. Enter average depth of very shallow zone (0.1 - 1 ft), $d_{vs}$   | $d_{vs} =$   | _____ ft              |
| 4-9. Calculate volume of very shallow zone, $V_{vs} = A_{vs} \cdot d_{vs}$   | $V_{vs} =$   | _____ ft <sup>3</sup> |
| 4-10. Enter width of very shallow zone, $W_{vs} = W_2$   | $W_{vs} =$   | _____ ft              |
| 4-11. Calculate length of very shallow zone, $L_{vs} = A_{vs} / W_{vs}$  | $L_{vs} =$   | _____ ft              |
| 4-12. Enter percent of surface area of shallow zone, % $A_s$   | $\%A_s =$    | _____                 |
| 4-13. Calculate surface area of shallow zone, $A_s = (A_2 \cdot \%A_s)/100$  | $A_s =$      | _____ ft <sup>2</sup> |
| 4-14. Enter average depth of shallow zone (1 - 3 ft), $d_s$  | $d_s =$      | _____ ft              |
| 4-15. Calculate volume of shallow zone, $V_s = A_s \cdot d_s$  | $V_s =$      | _____ ft <sup>3</sup> |
| 4-16. Enter width of shallow zone, $W_s = W_2$   | $W_s =$      | _____ ft              |
| 4-17. Calculate length of shallow zone, $L_s = A_s / W_s$  | $L_s =$      | _____ ft              |
| 4-18. Calculate surface area of deep zone, $A_{deep} = A_2 - A_{vs} - A_s$   | $A_{deep} =$ | _____ ft <sup>2</sup> |
| 4-19. Calculate volume of deep zone, $V_{deep} = V_2 - V_{vs} - V_s$   | $V_{deep} =$ | _____ ft <sup>3</sup> |
| 4-20. Calculate average depth of deep zone (3 - 5 ft), $d_{deep} = V_{deep} / A_{deep}$  | $d_{deep} =$ | _____ ft              |
| 4-21. Enter width of deep zone, $W_{deep} = W_2$   | $W_{deep} =$ | _____ ft              |
| 4-22. Calculate length of deep zone, $L_{deep} = A_{deep} / W_{deep}$  | $L_{deep} =$ | _____ ft              |
| <b>Step 5: Ensure Design Requirements and Site Constraints are Achieved</b>  |              |                       |
| 5-1. Check design requirements and site constraints. Modify design geometry until requirements are met. If the chosen site for the wetland is inadequate to meet the design requirements, choose a new location for the wetland.   |              |                       |

**Step 6: Size Outlet Structure**

6-1. Please refer to Appendix D for outlet structure sizing methodologies and examples. The wetland outlet pipe shall be sized, at a minimum, to pass flows greater than the water quality design peak flow for off-line basins or flow from the capital storm for on-line basins.

**Step 7: Determine Emergency Spillway Requirements**

7-1. For online basins, an emergency overflow spillway should be sized to pass the capital design storm in order to prevent overtopping of the walls or berms in the event that a blockage of the riser occurs. For offline basins, an emergency spillway or riser should be sized to pass the water quality design storm. For sites where the emergency spillway discharges to a steep slope, an emergency overflow riser, in addition to the spillway should be provided.

### Constructed Treatment Wetland Design Example

Wetland siting requires the following considerations prior to construction: (1) availability of base flow – storm water wetlands require a regular source of water to support wetland biota, (2) slope stability – storm water wetlands are not permitted near steep slope hazard areas, (3) surface space availability – large footprint area is required, and (4) compatibility with flood control – basins must not interfere with flood control functions of existing conveyance and detention structures.

The wetland in this example does not have extended detention. An internal berm separates the forebay (Cell 1) and the main basin (Cell 2). The berm is at the elevation of the active volume design surface which is also the permanent wetpool elevation.

#### Step 1: Determine Water Quality Design Volume

For this design example, a 10-acre residential development with a 60% total impervious area is considered.

| Step 1: Determine storm water quality design volume, $V_{wq}$  |  |
|--|--|
| 1-1. Determine the water quality design volume, $V_{wq}$ , using SBUH method, Appendix C (Note: $V_{wq}$ is always equal to $V_{one-inch}$ ) | $V_{wq} = \underline{\quad 27,500 \quad} \text{ ft}^3$ |

**Step 2: Determine Pond Location and Preliminary Geometry Based on Site Constraints**

A total footprint area and total length available for the wetland is provided. This step calculates the total active volume surface area which is equivalent to the permanent wetpool surface area. This step also calculates the dimensions of the internal berm.

| <b>Step 2: Determine Wetland Location, Wetland Type and Preliminary Geometry Based on Site Constraints</b>  |                |                        |
|---|----------------|------------------------|
| 2-1. Based on site constraints, determine the wetland geometry and the storage available by developing an elevation-storage relationship for the wetland. For this simple example, assume a trapezoidal geometry for cell 1 (forebay) and cell 2. The wetland does not have extended detention. |                |                        |
| 2-2. Enter the total surface area of the wetland footprint based on site constraints, $A_{tot}$   | $A_{tot} =$    | 11,000 ft <sup>2</sup> |
| 2-3. Enter the length of the wetland footprint based on site constraints, $L_{tot}$   | $L_{tot} =$    | 200 ft                 |
| 2-4. Calculate the width of the wetland footprint, $W_{tot} = A_{tot} / L_{tot}$  | $W_{tot} =$    | 55 ft                  |
| 2-5. Enter interior side slope as length per unit height (min = 3), $Z$   | $Z =$          | 3                      |
| 2-6. Enter desired freeboard depth, $d_{fb}$  | $d_{fb} =$     | 2 ft                   |
| 2-7. Calculate the length of the water quality surface area including the internal berm but excluding freeboard, $L_{wq-tot} = L_{tot} - 2Zd_{fb}$  | $L_{wq-tot} =$ | 188 ft                 |
| 2-8. Calculate the width of the water quality surface area including the internal berm but excluding freeboard, $W_{wq-tot} = W_{tot} - 2Zd_{fb}$   | $W_{wq-tot} =$ | 43 ft                  |
| 2-9. Calculate the total water quality surface area including the internal berm and excluding freeboard, $A_{wq-tot} = L_{wq-tot} \cdot W_{wq-tot}$   | $A_{wq-tot} =$ | 8,084 ft <sup>2</sup>  |
| 2-10. Enter the width of the internal berm (6 ft min), $W_{berm}$   | $W_{berm} =$   | 6 ft                   |
| 2-11. Enter the length of the internal berm, $L_{berm} = W_{wq-tot}$  | $L_{berm} =$   | 43 ft                  |
| 2-12. Calculate the area of the berm, $A_{berm} = W_{berm} \cdot L_{berm}$  | $A_{berm} =$   | 258 ft <sup>2</sup>    |
| 2-13. Calculate the active volume surface area excluding the internal berm and freeboard, $A_{wq} = A_{wq-tot} - A_{berm}$  | $A_{wq} =$     | 7,826 ft <sup>2</sup>  |

**Step 3: Determine Dimensions of Cell 1**

It should be assumed that cell 1 (the forebay) should be 15% of the water quality design volume,  $V_{wq}$ .

| <b>Step 3: Determine Dimensions of Cell 1</b>   |           |       |                 |
|---|-----------|-------|-----------------|
| 3-1. Enter the percent of $V_{wq}$ in Cell 1 (10-20% required), $\%V_1$   | $\%V_1 =$ | 15    | %               |
| 3-2. Calculate the active volume of Cell 1 (including sediment storage), $V_1 = (V_{wq} \cdot \%V_1)/100$                                   | $V_1 =$   | 4,125 | ft <sup>3</sup> |
| 3-3. Enter desired average depth of Cell 1 (5-9 ft including sediment storage of 1 ft), $d_1$   | $d_1 =$   | 5     | ft              |
| 3-4. Calculate the surface area for the water quality volume of Cell 1, $A_1 = V_1 / d_1$   | $A_1 =$   | 825   | ft <sup>2</sup> |
| 3-5. Enter the width of Cell 1, $W_1 = W_{av-tot} = L_{berm}$   | $W_1 =$   | 43    | ft              |
| 3-6. Calculate the length of Cell 1 ( <u>Note:</u> inlet and outlet should be configured to maximize the residence time), $L_1 = A_1 / W_1$ | $L_1 =$   | 19    | ft              |



**Step 4: Determine Dimensions of Cell 2**

Verify that the surface area and length-to-width ratio of Cell 2 meet the design criteria. Calculate volumes, depths, and surface areas for the very shallow, shallow and deep zones.

| <b>Step 4: Determine Dimensions of Cell 2</b>  |              |        |                 |
|--|--------------|--------|-----------------|
| 4-1. Calculate the active volume of Cell 2, $V_2 = V_{wq} - V_1$   | $V_2 =$      | 23,375 | ft <sup>3</sup> |
| 4-2. Calculate surface area of Cell 2, $A_2 = A_{wq} - A_1$  | $A_2 =$      | 7,001  | ft <sup>2</sup> |
| 4-3. Enter width of Cell 2, $W_2 = W_1 = W_{wq-tot} = L_{berm}$  | $W_2 =$      | 43     | ft              |
| 4-4. Calculate top length of Cell 2, $L_2 = A_2 / W_2$   | $L_2 =$      | 163    | ft              |
| 4-5. Verify that the length-to-width ratio of Cell 2 is at least 3:1 with $\geq 4:1$ preferred. If the length-to-width ratio is less than 3:1, modify input parameters until a ratio of at least 3:1 is achieved. If the input parameters cannot be modified as a result of site constraints, another site for the pond should be chosen, $LW_2 = L_2 / W_2$ |              |        |                 |
| 4-6. Enter percent of surface area of very shallow zone, % $A_{vs}$  | % $A_{vs} =$ | 15     | ft <sup>2</sup> |
| 4-7. Calculate very shallow zone surface area, $A_{vs} = (A_2 \cdot \%A_{vs})/100$   | $A_{vs} =$   | 1,050  | ft <sup>2</sup> |
| 4-8. Enter average depth of very shallow zone (0.1 - 1 ft), $d_{vs}$   | $d_{vs} =$   | 1      | ft              |
| 4-9. Calculate volume of very shallow zone, $V_{vs} = A_{vs} \cdot d_{vs}$   | $V_{vs} =$   | 1,050  | ft <sup>3</sup> |
| 4-10. Enter width of very shallow zone, $W_{vs} = W_2$   | $W_{vs} =$   | 43     | ft              |
| 4-11. Calculate length of very shallow zone, $L_{vs} = A_{vs} / W_{vs}$  | $L_{vs} =$   | 24     | ft              |
| 4-12. Enter percent of surface area of shallow zone, % $A_s$   | % $A_s =$    | 55     |                 |
| 4-13. Calculate surface area of shallow zone, $A_s = (A_2 \cdot \%A_s)/100$  | $A_s =$      | 3,851  | ft <sup>2</sup> |
| 4-14. Enter average depth of shallow zone (1 - 3 ft), $d_s$  | $d_s =$      | 3      | ft              |
| 4-15. Calculate volume of shallow zone, $V_s = A_s \cdot d_s$  | $V_s =$      | 11,552 | ft <sup>3</sup> |
| 4-16. Enter width of shallow zone, $W_s = W_2$   | $W_s =$      | 43     | ft              |
| 4-17. Calculate length of shallow zone, $L_s = A_s / W_s$  | $L_s =$      | 90     | ft              |
| 4-18. Calculate surface area of deep zone, $A_{deep} = A_2 - A_{vs} - A_s$   | $A_{deep} =$ | 2,100  | ft <sup>2</sup> |
| 4-19. Calculate volume of deep zone, $V_{deep} = V_2 - V_{vs} - V_s$   | $V_{deep} =$ | 10,773 | ft <sup>3</sup> |
| 4-20. Calculate average depth of deep zone (3 - 5 ft), $d_{deep} = V_{deep} / A_{deep}$  | $d_{deep} =$ | 5      | ft              |
| 4-21. Enter width of deep zone, $W_{deep} = W_2$   | $W_{deep} =$ | 43     | ft              |
| 4-22. Calculate length of deep zone, $L_{deep} = A_{deep} / W_{deep}$  | $L_{deep} =$ | 49     | ft              |

**Step 5: Ensure Design Requirements and Site Conditions are Achieved**

Check design requirements and site constraints. Modify design geometry until requirements are met. If the chosen site for the wetland is inadequate to meet the design requirements, choose a new location for the wetland.

**Step 6: Size Outlet Structure**

Please refer to Appendix E for wetland outlet structure sizing methodologies and examples. The wetland outlet pipe shall be sized, at a minimum, to pass flows greater than the water quality design peak flow for off-line basins or flow from the capital storm for on-line basins.

**Step 7: Determine Emergency Spillway Requirements**

For online basins, an emergency overflow spillway should be sized to pass the capital design storm to prevent overtopping of the walls or berms in the event that a blockage of the riser occurs. For offline basins, an emergency spillway or riser should be sized to pass the water quality design storm. For sites where the emergency spillway discharges to a steep slope, an emergency overflow riser, in addition to the spillway should be provided.

Wet Retention Basin Worksheet

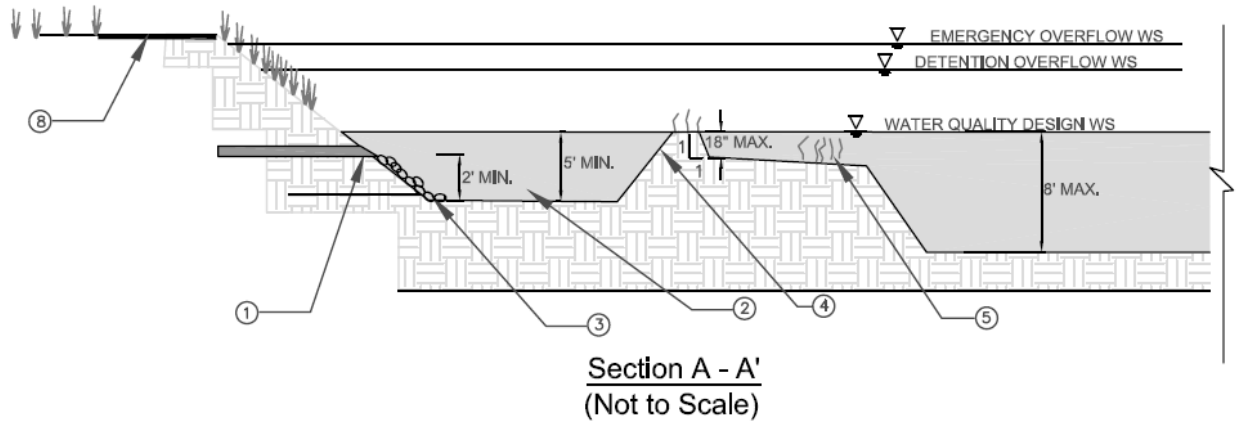

Figure D-8: Wet Retention Basin cross-section

Refer to Figure D-8 and Figure 6-24 for a diagrammatic description of the geometric variables.

|  |                         |
|--|-------------------------|
| <b>Step 1: Determine storm water quality design volume, <math>V_{wq}</math></b>  |                         |
| 1-1. Determine the water quality design volume, $V_{wq}$ , using SBUH method, Appendix C (Note: $V_{wq}$ is always equal to $V_{one-inch}$ ) | $V_{wq} =$ _____ $ft^3$ |
| <b>Step 2: Determine Active Design Volume for the Wet Pond without Extended Detention</b>  |                         |
| 2-1. Calculate the active design volume (without extended detention), $V_a = 1.05V_{wq}$   | $V_a =$ _____ $ft^3$    |

| Step 3: Determine Pond Location and Preliminary Geometry Based on Site Constraints  |                      |                 |
|---|----------------------|-----------------|
| 3-1. Based on site constraints, determine the pond geometry and the storage available by developing an elevation-storage relationship for the pond. For this simple example, assume a trapezoidal geometry for cell 1 (forebay) and cell 2. |                      |                 |
| 3-2. Enter the total surface area of the pond footprint based on site constraints, $A_{tot}$  | $A_{tot} =$ _____    | ft <sup>2</sup> |
| 3-3. Enter the length of the pond footprint based on site constraints, $L_{tot}$  | $L_{tot} =$ _____    | ft              |
| 3-4. Calculate the width of the pond footprint, $W_{tot} = A_{tot} / L_{tot}$   | $W_{tot} =$ _____    | ft              |
| 3-5. Enter interior side slope as length per unit height (min = 3), $Z$   | $Z =$ _____          |                 |
| 3-6. Enter desired freeboard depth, $d_{fb}$  | $d_{fb} =$ _____     | ft              |
| 3-7. Calculate the length of the active volume surface area including the internal berm but excluding freeboard, $L_{av-tot} = L_{tot} - 2Zd_{fb}$  | $L_{av-tot} =$ _____ | ft              |
| 3-8. Calculate the width of the active volume surface area including the internal berm but excluding freeboard, $W_{av-tot} = W_{tot} - 2Zd_{fb}$   | $W_{av-tot} =$ _____ | ft              |
| 3-9. Calculate the total water quality surface area including the internal berm and excluding freeboard, $A_{av-tot} = L_{av-tot} \cdot W_{av-tot}$   | $A_{av-tot} =$ _____ | ft <sup>2</sup> |
| 3-10. Enter the width of the internal berm (6 ft min), $W_{berm}$   | $W_{berm} =$ _____   | ft              |
| 3-11. Enter the length of the internal berm, $L_{berm} = W_{av-tot}$  | $L_{berm} =$ _____   | ft              |
| 3-12. Calculate the area of the berm, $A_{berm} = W_{berm} \cdot L_{berm}$  | $A_{berm} =$ _____   | ft <sup>2</sup> |
| 3-13. Calculate the active volume surface area excluding the internal berm and freeboard, $A_{av} = A_{av-tot} - A_{berm}$  | $A_{av} =$ _____     | ft <sup>2</sup> |
| Step 4: Determine Dimensions of Cell 1  |                      |                 |
| 4-1. Enter the percent of $V_a$ in Cell 1, $\%V_1$  | $\%V_1 =$ _____      | %               |
| 4-2. Calculate the active volume of Cell 1 (including sediment storage), $V_1 = (V_a \cdot \%V_1)/100$  | $V_1 =$ _____        | ft <sup>3</sup> |
| 4-3. Enter desired average depth of Cell 1 (5-9 ft including sediment storage of 1 ft), $d_1$   | $d_1 =$ _____        | ft              |
| 4-4. Calculate the surface area for the active volume of Cell 1, $A_1 = V_1 / d_1$  | $A_1 =$ _____        | ft <sup>2</sup> |
| 4-5. Enter the width of Cell 1, $W_1 = W_{av-tot} = L_{berm}$   | $W_1 =$ _____        | ft              |
| 4-6. Calculate the length of Cell 1 ( <u>Note</u> : inlet and outlet should be configured to maximize the residence time), $L_1 = A_1 / W_1$  | $L_1 =$ _____        | ft              |

| <b>Step 5: Determine Dimensions of Cell 2</b>  |   |
|--|---|
| 5-1. Calculate the active volume of Cell 2, $V_2 = V_a - V_1$  | $V_2 =$ _____ $\text{ft}^3$             |
| 5-2. Determine <u>minimum</u> wetpool surface area, $A_{\text{min}2} = V_2 \cdot 0.3$  | $A_{\text{min}2} =$ _____ $\text{ft}^2$ |
| 5-3. Determine actual wetpool surface area, $A_2 = A_{\text{av}} - A_1$  | $A_2 =$ _____ $\text{ft}^2$             |
| 5-4. If $A_2$ is greater than $A_{\text{min}2}$ then move on to step 5-5. If $A_2$ is less than $A_{\text{min}2}$ , then modify input parameters to increase $A_2$ until it is greater than $A_{\text{min}2}$ . If site constraints limit this criterion, then another site for the pond should be chosen.   |   |
| 5-5. Enter width of Cell 2, $W_2 = W_1 = W_{\text{av-tot}} = L_{\text{berm}}$  | $W_2 =$ _____ $\text{ft}$               |
| 5-6. Calculate top length of Cell 2, $L_2 = A_2 / W_2$   | $L_2 =$ _____ $\text{ft}$               |
| 5-7. Verify that the length-to-width ratio of Cell 2 is at least 1.5:1 with $\geq 2:1$ preferred. If the length-to-width ratio is less than 1.5:1, modify input parameters until a ratio of at least 1.5:1 is achieved. If the input parameters cannot be modified as a result of site constraints, another site for the pond should be chosen, $LW_2 = L_2 / W_2$ |   |
|  | $LW_2 =$ _____                          |
| 5-8. Enter percent of surface area that will be planted with emergent vegetation (25-75%), $\%A_{\text{ev}}$   | $\%A_{\text{ev}} =$ _____ $\%$          |
| 5-9. Calculate emergent vegetation surface area, $A_{\text{ev}} = (A_2 \cdot \%A_{\text{ev}}) / 100$   | $A_{\text{ev}} =$ _____ $\text{ft}^2$   |
| 5-10. Enter average depth of emergent vegetation shallow zone (1.5 - 3 ft), $d_{\text{ev}}$  | $d_{\text{ev}} =$ _____ $\text{ft}$     |
| 5-11. Calculate volume of emergent vegetation shallow zone (1.5 - 3 ft), $V_{\text{ev}} = A_{\text{ev}} \cdot d_{\text{ev}}$   | $V_{\text{ev}} =$ _____ $\text{ft}^3$   |
| 5-12. Enter width of emergent vegetation shallow zone, $W_{\text{ev}} = W_2$   | $W_{\text{ev}} =$ _____ $\text{ft}$     |
| 5-13. Calculate length of emergent vegetation shallow zone, $L_{\text{ev}} = A_{\text{ev}} / W_{\text{ev}}$  | $L_{\text{ev}} =$ _____ $\text{ft}$     |
| 5-14. Calculate volume in deep zone, $V_{\text{deep}} = V_2 - V_{\text{ev}}$   | $V_{\text{deep}} =$ _____ $\text{ft}^3$ |
| 5-15. Calculate surface area of deep (>3 ft) zone, $A_{\text{deep}} = A_2 - A_{\text{ev}}$   | $A_{\text{deep}} =$ _____ $\text{ft}^2$ |
| 5-16. Calculate the average depth in deep zone (4-8 ft), $d_{\text{deep}} = V_{\text{deep}} / A_{\text{deep}}$   | $d_{\text{deep}} =$ _____ $\text{ft}$   |
| 5-17. Enter width of deep zone, $W_{\text{deep}} = W_2$  | $W_{\text{deep}} =$ _____ $\text{ft}$   |
| 5-18. Calculate length of deep zone, $L_{\text{deep}} = A_{\text{deep}} / W_{\text{deep}}$   | $L_{\text{deep}} =$ _____ $\text{ft}$   |
| <b>Step 6: Ensure Design Requirements and Site Constraints are Achieved</b>  |   |
| 6-1. Check design requirements and site constraints. Modify design geometry until requirements are met. If the chosen site for the pond is inadequate to meet the design requirements, choose a new location for the pond.   |   |

**Step 7: Size Outlet Structure**

7-1. Please refer to Appendix D for pond outlet structure sizing methodologies and examples. The pond outlet pipe shall be sized, at a minimum, to pass flows greater than the water quality design peak flow for off-line basins or flow from the capital storm for on-line basins.

**Step 8: Determine Emergency Spillway Requirements**

8-1. For online basins, an emergency overflow spillway should be sized to pass the capital design storm to prevent overtopping of the walls or berms in the event that a blockage of the riser occurs. For offline basins, an emergency spillway or riser should be sized to pass the water quality design storm. For sites where the emergency spillway discharges to a steep slope, an emergency overflow riser, in addition to the spillway should be provided.

### Wet Retention Basin Design Example

Wet retention basin siting requires the following considerations prior to construction: (1) availability of base flow – wet retention basins require a regular source of water if water level is to be maintained, (2) surface space availability – large footprint area is required, and (3) compatibility with flood control – basins must not interfere with flood control functions of existing conveyance and detention structures.

The wet retention basin in this example does not have extended detention. An internal berm separates the forebay (Cell 1) and the main basin (Cell 2). The berm is at the elevation of the active volume design surface which is also the permanent wetpool elevation.

#### Step 1: Determine Water Quality Design Volume

For this design example, a 10-acre residential development with a 60% total impervious area is considered.

| <b>Step 1: Determine storm water quality design volume, <math>V_{wq}</math></b>   |  |
|---|--|
| 1-1. Determine the water quality design volume, $V_{wq}$ , using SBUH method, Appendix C ( <u>Note</u> : $V_{wq}$ is always equal to $V_{one-inch}$ ) | $V_{wq} = \underline{\hspace{2cm} 25,700 \hspace{2cm}} \text{ ft}^3$ |

#### Step 2: Determine Active Design Volume for a Wet Retention Basin without Extended Detention

If there is no extended detention provided, wet retention basins shall be sized to provide a minimum wet pool volume equal to the water quality design volume plus an additional 5% for sediment accumulation.

| <b>Step 2: Determine Active Design Volume for the Wet Pond without Extended Detention</b> |   |
|---|---|
| 2-1. Calculate the active design volume (without extended detention), $V_a = 1.05V_{wq}$  | $V_a = \underline{\hspace{2cm} 26,985 \hspace{2cm}} \text{ ft}^3$ |

**Step 3: Determine Retention Basin Location and Preliminary Geometry Based on Site Constraints**

A total footprint area and total length available for the basin is provided. This step calculates the total active volume surface area which is equivalent to the permanent wetpool surface area. This step also calculates the dimensions of the internal berm.

| <b>Step 3: Determine Pond Location and Preliminary Geometry Based on Site Constraints</b>   |                |                                     |
|---|----------------|-------------------------------------|
| 3-1. Based on site constraints, determine the pond geometry and the storage available by developing an elevation-storage relationship for the pond. For this simple example, assume a trapezoidal geometry for cell 1 (forebay) and cell 2. |                |                                     |
| 3-2. Enter the total surface area of the pond footprint based on site constraints, $A_{tot}$  | $A_{tot} =$    | $\frac{11,000}{\quad} \text{ ft}^2$ |
| 3-3. Enter the length of the pond footprint based on site constraints, $L_{tot}$  | $L_{tot} =$    | $\frac{200}{\quad} \text{ ft}$      |
| 3-4. Calculate the width of the pond footprint, $W_{tot} = A_{tot} / L_{tot}$   | $W_{tot} =$    | $\frac{55}{\quad} \text{ ft}$       |
| 3-5. Enter interior side slope as length per unit height (min = 3), $Z$   | $Z =$          | $\frac{3}{\quad}$                   |
| 3-6. Enter desired freeboard depth, $d_{fb}$  | $d_{fb} =$     | $\frac{2}{\quad} \text{ ft}$        |
| 3-7. Calculate the length of the active volume surface area including the internal berm but excluding freeboard, $L_{av-tot} = L_{tot} - 2Zd_{fb}$  | $L_{av-tot} =$ | $\frac{188}{\quad} \text{ ft}$      |
| 3-8. Calculate the width of the active volume surface area including the internal berm but excluding freeboard, $W_{av-tot} = W_{tot} - 2Zd_{fb}$   | $W_{av-tot} =$ | $\frac{43}{\quad} \text{ ft}$       |
| 3-9. Calculate the total water quality surface area including the internal berm and excluding freeboard, $A_{av-tot} = L_{av-tot} \cdot W_{av-tot}$   | $A_{av-tot} =$ | $\frac{8,084}{\quad} \text{ ft}^2$  |
| 3-10. Enter the width of the internal berm (6 ft min), $W_{berm}$   | $W_{berm} =$   | $\frac{6}{\quad} \text{ ft}$        |
| 3-11. Enter the length of the internal berm, $L_{berm} = W_{av-tot}$  | $L_{berm} =$   | $\frac{43}{\quad} \text{ ft}$       |
| 3-12. Calculate the area of the berm, $A_{berm} = W_{berm} \cdot L_{berm}$  | $A_{berm} =$   | $\frac{258}{\quad} \text{ ft}^2$    |
| 3-13. Calculate the active volume surface area excluding the internal berm and freeboard, $A_{av} = A_{av-tot} - A_{berm}$  | $A_{av} =$     | $\frac{7,826}{\quad} \text{ ft}^2$  |



**Step 4: Determine Dimensions of Cell 1**

It should be assumed that Cell 1 (the forebay) should be 20% of the total active design volume,  $V_a$ .

| Step 4: Determine Dimensions of Cell 1   |           |       |                 |
|--|-----------|-------|-----------------|
| 4-1. Enter the percent of $V_a$ in Cell 1, $\%V_1$   | $\%V_1 =$ | 20    | %               |
| 4-2. Calculate the active volume of Cell 1 (including sediment storage), $V_1 = (V_a \cdot \%V_1)/100$                                       | $V_1 =$   | 5,397 | ft <sup>3</sup> |
| 4-3. Enter desired average depth of Cell 1 (5-9 ft including sediment storage of 1 ft), $d_1$  | $d_1 =$   | 5     | ft              |
| 4-4. Calculate the surface area for the active volume of Cell 1, $A_1 = V_1 / d_1$   | $A_1 =$   | 1,079 | ft <sup>2</sup> |
| 4-5. Enter the width of Cell 1, $W_1 = W_{av-tot} = L_{berm}$  | $W_1 =$   | 43    | ft              |
| 4-6. Calculate the length of Cell 1 ( <u>Note</u> : inlet and outlet should be configured to maximize the residence time), $L_1 = A_1 / W_1$ | $L_1 =$   | 25    | ft              |

**Step 5: Determine Dimensions of Cell 2**

Verify that the surface area and length-to-width ratio of Cell 2 meet the design criteria. Calculate volumes, depths and surface areas for the emergent vegetation shallow zone and the deep zone.

| Step 5: Determine Dimensions of Cell 2   |              |        |                 |
|--|--------------|--------|-----------------|
| 5-1. Calculate the active volume of Cell 2, $V_2 = V_a - V_1$  | $V_2 =$      | 21,588 | ft <sup>3</sup> |
| 5-2. Determine <u>minimum</u> wetpool surface area, $A_{min2} = V_2 \cdot 0.3$   | $A_{min2} =$ | 6,476  | ft <sup>2</sup> |
| 5-3. Determine actual wetpool surface area, $A_2 = A_{av} - A_1$   | $A_2 =$      | 6,747  | ft <sup>2</sup> |
| 5-4. If $A_2$ is greater than $A_{min2}$ then move on to step 5-5. If $A_2$ is less than $A_{min2}$ , then modify input parameters to increase $A_2$ until it is greater than $A_{min2}$ . If site constraints limit this criterion, then another site for the pond should be chosen.  |              |        |                 |
| 5-5. Enter width of Cell 2, $W_2 = W_1 = W_{av-tot} = L_{berm}$  | $W_2 =$      | 43     | ft              |
| 5-6. Calculate top length of Cell 2, $L_2 = A_2 / W_2$   | $L_2 =$      | 157    | ft              |
| 5-7. Verify that the length-to-width ratio of Cell 2 is at least 1.5:1 with $\geq 2:1$ preferred. If the length-to-width ratio is less than 1.5:1, modify input parameters until a ratio of at least 1.5:1 is achieved. If the input parameters cannot be modified as a result of site constraints, another site for the pond should be chosen, $LW_2 = L_2 / W_2$ |              |        |                 |
|  | $LW_2 =$     | 4      |                 |

| Step 5: Determine Dimensions of Cell 2   |                     |                                      |
|--|---------------------|--------------------------------------|
| 5-8. Enter percent of surface area that will be planted with emergent vegetation (25-75%), %A <sub>ev</sub>                  | %A <sub>ev</sub> =  | 25 %                                 |
| 5-9. Calculate emergent vegetation surface area, A <sub>ev</sub> = (A <sub>2</sub> • %A <sub>ev</sub> )/100                  | A <sub>ev</sub> =   | $\frac{1,687}{100}$ ft <sup>2</sup>  |
| 5-10. Enter average depth of emergent vegetation shallow zone (1.5 - 3 ft), d <sub>ev</sub>                                  | d <sub>ev</sub> =   | $\frac{2}{1}$ ft                     |
| 5-11. Calculate volume of emergent vegetation shallow zone (1.5 - 3 ft), V <sub>ev</sub> = A <sub>ev</sub> • d <sub>ev</sub> | V <sub>ev</sub> =   | $\frac{3,373}{100}$ ft <sup>3</sup>  |
| 5-12. Enter width of emergent vegetation shallow zone, W <sub>ev</sub> = W <sub>2</sub>                                      | W <sub>ev</sub> =   | $\frac{43}{1}$ ft                    |
| 5-13. Calculate length of emergent vegetation shallow zone, L <sub>ev</sub> = A <sub>ev</sub> / W <sub>ev</sub>              | L <sub>ev</sub> =   | $\frac{39}{1}$ ft                    |
| 5-14. Calculate volume in deep zone, V <sub>deep</sub> = V <sub>2</sub> - V <sub>ev</sub>                                    | V <sub>deep</sub> = | $\frac{18,215}{100}$ ft <sup>3</sup> |
| 5-15. Calculate surface area of deep (>3 ft) zone, A <sub>deep</sub> = A <sub>2</sub> - A <sub>ev</sub>                      | A <sub>deep</sub> = | $\frac{5,060}{100}$ ft <sup>2</sup>  |
| 5-16. Calculate the average depth in deep zone (4-8 ft), d <sub>deep</sub> = V <sub>deep</sub> / A <sub>deep</sub>           | d <sub>deep</sub> = | $\frac{4}{1}$ ft                     |
| 5-17. Enter width of deep zone, W <sub>deep</sub> = W <sub>2</sub>   | W <sub>deep</sub> = | $\frac{43}{1}$ ft                    |
| 5-18. Calculate length of deep zone, L <sub>deep</sub> = A <sub>deep</sub> / W <sub>deep</sub>                               | L <sub>deep</sub> = | $\frac{118}{1}$ ft                   |

**Step 6: Ensure Design Requirements and Site Conditions are Achieved**

Check design requirements and site constraints. Modify design geometry until requirements are met. If the chosen site for the basin is inadequate to meet the design requirements, choose a new location for the basin.

**Step 7: Size Outlet Structure**

Please refer to Appendix F for basin outlet structure sizing methodologies and examples. The basin outlet pipe shall be sized, at a minimum, to pass flows greater than the water quality design peak flow for off-line basins or flow from the capital storm for on-line basins.

**Step 8: Determine Emergency Spillway Requirements**

For online basins, an emergency overflow spillway should be sized to pass the capital design storm to prevent overtopping of the walls or berms in the event that a blockage of the riser occurs. For offline basins, an emergency spillway or riser should be sized to pass the water quality design storm. For sites where the emergency spillway discharges to a steep slope, an emergency overflow riser, in addition to the spillway should be provided.

**Footnotes**

Wetpool volumes less than or equal to 4,000 cubic feet (or 0.0918 acre-feet) may be single celled.

**Dry Extended Detention Basin Worksheet**

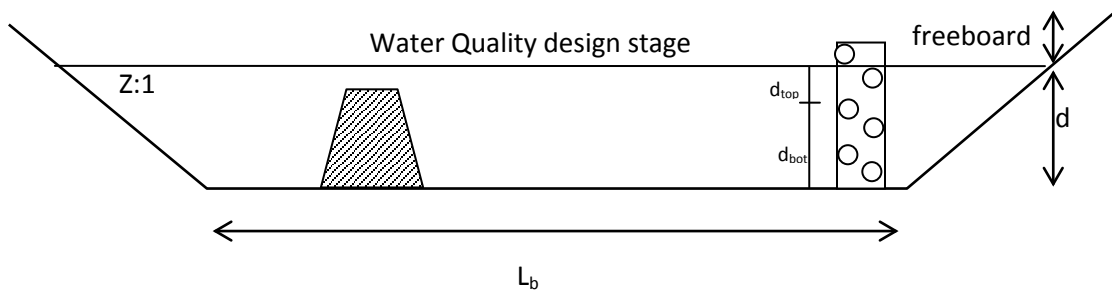

Figure D-9: Extended detention basin longitudinal profile

Refer to Figure D-9 and Figure 6-28 for a diagrammatic description of the geometric variables.

| <b>Step 1: Determine design volume reduction, <math>V_{\text{reduction}}</math></b>  |  |
|--|--|
| 1-1. Enter the volume difference between the pre- and post-development conditions for the 25-yr, 24-hr design storm, $V_{25}$ , calculated using SBUH method, Appendix C   | $V_{25} =$ _____ $\text{ft}^3$               |
| 1-2. Enter the volume generated from a one-inch, 24-hr storm event, $V_{\text{one-inch}}$ , calculated using SBUH method, Appendix C                                       | $V_{\text{one-inch}} =$ _____ $\text{ft}^3$  |
| 1-3. Determine design volume reduction which is the larger of $V_{25}$ and $V_{\text{one-inch}}$ and is the volume to be retained on-site                                  | $V_{\text{reduction}} =$ _____ $\text{ft}^3$ |
| <b>Step 2: Determine storm water quality design volume, <math>V_{\text{wq}}</math></b>   |  |
| 2-1. Determine the water quality design volume, $V_{\text{wq}}$ , using SBUH method, Appendix C ( <u>Note</u> : $V_{\text{wq}}$ is always equal to $V_{\text{one-inch}}$ ) | $V_{\text{wq}} =$ _____ $\text{ft}^3$        |
| <b>Step 3: Determine design volume, <math>V_{\text{design}}</math> (for sizing)</b>  |  |
| 3-1. $V_{\text{design}} =$ the larger of $V_{\text{reduction}}$ and $V_{\text{wq}}$  | $V_{\text{design}} =$ _____ $\text{ft}^3$    |
| <b>Step 4: Calculate the volume of the active basin</b>  |  |
| 4-1. Calculate basin active volume, $V_a = 1.05V_{\text{wq}}$  | $V_a =$ _____ $\text{ft}^3$                  |

**Step 5: Determine Detention Basin Location and Preliminary Geometry Based on Site Constraints**

5-1. Based on site constraints, determine the basin geometry and the storage available by developing an elevation-storage relationship for the basin. For this simple example, assume a trapezoidal geometry for cell 1 (forebay) and cell 2.

5-2. Enter the total surface area of the basin footprint based on site constraints,  $A_{tot}$

$A_{tot} =$  \_\_\_\_\_  $ft^2$

5-3. Enter the length of the basin footprint based on site constraints,  $L_{tot}$

$L_{tot} =$  \_\_\_\_\_  $ft$

5-4. Calculate the width of the basin footprint,  $W_{tot} = A_{tot} / L_{tot}$

$W_{tot} =$  \_\_\_\_\_  $ft$

5-5. Enter interior side slope as length per unit height (min = 3),  $Z$

$Z =$  \_\_\_\_\_

5-6. Enter desired freeboard depth,  $d_{fb}$

$d_{fb} =$  \_\_\_\_\_  $ft$

5-7. Calculate the length of the active volume surface area including the internal berm but excluding freeboard,  $L_{av-tot} = L_{tot} - 2Zd_{fb}$

$L_{av-tot} =$  \_\_\_\_\_  $ft$

5-8. Calculate the width of the active volume surface area including the internal berm but excluding freeboard,  $W_{av-tot} = W_{tot} - 2Zd_{fb}$

$W_{av-tot} =$  \_\_\_\_\_  $ft$

5-9. Calculate the total active volume surface area including the internal berm and excluding freeboard,  $A_{av-tot} = L_{av-tot} \cdot W_{av-tot}$

$A_{av-tot} =$  \_\_\_\_\_  $ft^2$

5-10. Enter the width of the internal berm (6 ft min),  $W_{berm}$

$W_{berm} =$  \_\_\_\_\_  $ft$

5-11. Enter the length of the internal berm,  $L_{berm} = W_{av-tot}$

$L_{berm} =$  \_\_\_\_\_  $ft$

5-12. Calculate the area of the berm,  $A_{berm} = W_{berm} \cdot L_{berm}$

$A_{berm} =$  \_\_\_\_\_  $ft^2$

5-13. Calculate the water quality surface area excluding the internal berm and freeboard,  $A_{av} = A_{av-tot} - A_{berm}$

$A_{av} =$  \_\_\_\_\_  $ft^2$

**Step 6: Determine Dimensions of Cell 1**

6-1. Enter the percent of  $V_a$  in Cell 1 (25% required),  $\%V_1$

$\%V_1 =$  \_\_\_\_\_  $\%$

6-2. Calculate the active volume of Cell 1 (including sediment storage),  $V_1 = (V_a \cdot \%V_1) / 100$

$V_1 =$  \_\_\_\_\_  $ft^3$

6-3. Enter a desired average depth for the active volume of Cell 1,  $d_1$

$d_1 =$  \_\_\_\_\_  $ft$

6-4. Calculate the surface area for the active volume of Cell 1,  $A_1 = V_1 / d_1$

$A_1 =$  \_\_\_\_\_  $ft^2$

6-5. Enter the width of Cell 1,  $W_1 = W_{av-tot} = L_{berm}$

$W_1 =$  \_\_\_\_\_  $ft$

6-6. Calculate the length of Cell 1 (Note: inlet and outlet should be configured to maximize the residence time),  $L_1 = A_1 / W_1$

$L_1 =$  \_\_\_\_\_  $ft$

| <b>Step 7: Determine Dimensions of Cell 2</b>  |                                |
|--|--------------------------------|
| 7-1. Calculate the active volume of Cell 2, $V_2 = V_a - V_1$  | $V_2 =$ _____ $\text{ft}^3$    |
| 7-2. Calculate the surface area of the active volume of Cell 2, $A_2 = A_{av} - A_1$   | $A_2 =$ _____ $\text{ft}^2$    |
| 7-3. Calculate the average depth of the active volume of Cell 2, $d_2 = V_2 / A_2$   | $d_2 =$ _____ $\text{ft}$      |
| 7-4. Enter the width of Cell 2, $W_2 = W_1 = W_{av-tot} = L_{berm}$  | $W_2 =$ _____ $\text{ft}$      |
| 7-5. Calculate the length of Cell 2, $L_2 = A_2 / W_2$   | $L_2 =$ _____ $\text{ft}$      |
| 7-6. Calculate the width of Cell 2 at half of $d_2$ , $W_{mid2} = W_2 - Zd_2$  | $W_{mid2} =$ _____ $\text{ft}$ |
| 7-7. Calculate the length of Cell 2 at half of $d_2$ , $L_{mid2} = W_2 - Zd_2$   | $L_{mid2} =$ _____ $\text{ft}$ |
| 7-8. Verify that the length-to-width ratio of Cell 2 at half of $d_2$ is at least 1.5:1 with $\geq 2:1$ preferred. If the length-to-width ratio is less than 1.5:1, modify input parameters until a ratio of at least 1.5:1 is achieved. If the input parameters cannot be modified as a result of site constraints, another site for the basin should be chosen, $LW_{mid2} = L_{mid2} / W_{mid2}$  | $LW_{mid2} =$ _____            |
| <b>Step 8: Ensure Design Requirements and Site Constraints are Achieved</b>  |                                |
| 8-1. Check design requirements and site constraints. Modify design geometry until requirements are met. If the chosen site for the basin is inadequate to meet the design requirements, choose a new location.   |                                |
| <b>Step 9: Size Outlet Structure</b>   |                                |
| 9-1. Refer to Appendix F for basin outlet structure sizing methodologies and examples. The total drawdown time for the basin should be 48 hours. The outlet structure shall be designed to release the bottom 50% of the detention volume (half-full to empty) over 32 hours, and the top half (full to half-full) in 16 hours. A primary overflow should be sized to pass the peak flow rate from the developed capital design storm.                                       |                                |
| <b>Step 10: Determine Emergency Spillway Requirements</b>  |                                |
| 10-1. For online basins, an emergency overflow spillway should be sized to pass the capital design storm in order to prevent overtopping of the walls or berms in the event that a blockage of the riser occurs. For offline basins, an emergency spillway or riser should be sized to pass the water quality design storm. For sites where the emergency spillway discharges to a steep slope, an emergency overflow riser, in addition to the spillway should be provided. |                                |

## Dry Extended Detention Basin Design Example

### Step 1: Determine Storm Water Quality Design Volume Reduction, $V_{\text{reduction}}$

| Step 1: Determine design volume reduction, $V_{\text{reduction}}$  |                          |                        |
|--|--------------------------|------------------------|
| 1-1. Enter the volume difference between the pre- and post-development conditions for the 25-yr, 24-hr design storm, $V_{25}$ , calculated using SBUH method, Appendix C | $V_{25} =$               | 20 ft <sup>3</sup>     |
| 1-2. Enter the volume generated from a one-inch, 24-hr storm event, $V_{\text{one-inch}}$ , calculated using SBUH method, Appendix C                                     | $V_{\text{one-inch}} =$  | 25,700 ft <sup>3</sup> |
| 1-3. Determine design volume reduction which is the larger of $V_{25}$ and $V_{\text{one-inch}}$ and is the volume to be retained on-site, if practical and feasible     | $V_{\text{reduction}} =$ | 25,700 ft <sup>3</sup> |

### Step 2: Determine Storm Water Quality Design Volume, $V_{\text{wq}}$

| Step 2: Determine storm water quality design volume, $V_{\text{wq}}$   |                   |                        |
|--|-------------------|------------------------|
| 2-1. Determine the water quality design volume, $V_{\text{wq}}$ , using SBUH method, Appendix C ( <u>Note</u> : $V_{\text{wq}}$ is always equal to $V_{\text{one-inch}}$ ) | $V_{\text{wq}} =$ | 25,700 ft <sup>3</sup> |

### Step 3: Determine Design Volume, $V_{\text{design}}$

| Step 3: Determine design volume, $V_{\text{design}}$ (for sizing)                   |                       |                        |
|---|-----------------------|------------------------|
| 3-1. $V_{\text{design}} =$ the larger of $V_{\text{reduction}}$ and $V_{\text{wq}}$ | $V_{\text{design}} =$ | 25,700 ft <sup>3</sup> |

### Step 4: Calculate Volume of the Active Basin and the Forebay Basin

| Step 4: Calculate the volume of the active basin              |         |                        |
|---|---------|------------------------|
| 4-1. Calculate basin active volume, $V_a = 1.05V_{\text{wq}}$ | $V_a =$ | 26,985 ft <sup>3</sup> |

**Step 5: Determine Detention Basin Location and Preliminary Geometry Based on Site Constraints**

The detention basin in this example has an internal berm separating the forebay (Cell 1) and the main basin (Cell 2). The internal berm elevation is equivalent to the elevation of the active design volume. The berm length is equal to the width of the basin when filled to the active design volume.

| <b>Step 5: Determine Detention Basin Location and Preliminary Geometry Based on Site Constraints</b>  |                |                        |
|---|----------------|------------------------|
| 5-1. Based on site constraints, determine the basin geometry and the storage available by developing an elevation-storage relationship for the basin. For this simple example, assume a trapezoidal geometry for cell 1 (forebay) and cell 2. |                |                        |
| 5-2. Enter the total surface area of the basin footprint based on site constraints, $A_{tot}$   | $A_{tot} =$    | 11,000 ft <sup>2</sup> |
| 5-3. Enter the length of the basin footprint based on site constraints, $L_{tot}$   | $L_{tot} =$    | 200 ft                 |
| 5-4. Calculate the width of the basin footprint, $W_{tot} = A_{tot} / L_{tot}$  | $W_{tot} =$    | 55 ft                  |
| 5-5. Enter interior side slope as length per unit height (min = 3), $Z$   | $Z =$          | 3                      |
| 5-6. Enter desired freeboard depth, $d_{fb}$  | $d_{fb} =$     | 2 ft                   |
| 5-7. Calculate the length of the active volume surface area including the internal berm but excluding freeboard, $L_{av-tot} = L_{tot} - 2Zd_{fb}$  | $L_{av-tot} =$ | 188 ft                 |
| 5-8. Calculate the width of the active volume surface area including the internal berm but excluding freeboard, $W_{av-tot} = W_{tot} - 2Zd_{fb}$   | $W_{av-tot} =$ | 43 ft                  |
| 5-9. Calculate the total active volume surface area including the internal berm and excluding freeboard, $A_{av-tot} = L_{av-tot} \cdot W_{av-tot}$   | $A_{av-tot} =$ | 8,084 ft <sup>2</sup>  |
| 5-10. Enter the width of the internal berm (6 ft min), $W_{berm}$   | $W_{berm} =$   | 6 ft                   |
| 5-11. Enter the length of the internal berm, $L_{berm} = W_{av-tot}$  | $L_{berm} =$   | 43 ft                  |
| 5-12. Calculate the area of the berm, $A_{berm} = W_{berm} \cdot L_{berm}$  | $A_{berm} =$   | 258 ft <sup>2</sup>    |
| 5-13. Calculate the water quality surface area excluding the internal berm and freeboard, $A_{av} = A_{av-tot} - A_{berm}$  | $A_{av} =$     | 7,826 ft <sup>2</sup>  |



**Step 6: Calculate Dimensions of Cell 1**

Calculate the dimensions of the forebay (Cell 1) based on the active design volume for Cell 1 (25% of  $V_a$ ) and a desired average depth,  $d_1$ . The width of the forebay,  $W_1$ , is equivalent to the length of the berm,  $L_{\text{berm}}$ , and the width of Cell 2,  $W_2$ .

| <b>Step 6: Determine Dimensions of Cell 1</b>  |           |       |                 |
|--|-----------|-------|-----------------|
| 6-1. Enter the percent of $V_a$ in Cell 1 (25% required), $\%V_1$  | $\%V_1 =$ | 25    | %               |
| 6-2. Calculate the active volume of Cell 1 (including sediment storage),<br>$V_1 = (V_a \cdot \%V_1)/100$                                    | $V_1 =$   | 6,746 | ft <sup>3</sup> |
| 6-3. Enter a desired average depth for the active volume of Cell 1, $d_1$  | $d_1 =$   | 5     | ft              |
| 6-4. Calculate the surface area for the active volume of Cell 1, $A_1 = V_1 / d_1$   | $A_1 =$   | 1,349 | ft <sup>2</sup> |
| 6-5. Enter the width of Cell 1, $W_1 = W_{\text{av-tot}} = L_{\text{berm}}$  | $W_1 =$   | 43    | ft              |
| 6-6. Calculate the length of Cell 1 ( <u>Note</u> : inlet and outlet should be configured to maximize the residence time), $L_1 = A_1 / W_1$ | $L_1 =$   | 31    | ft              |

**Step 7: Calculate the Dimensions of Cell 2**

Calculate the dimensions of the main basin (Cell 2) based on the active design volume for Cell 2 and a desired average depth,  $d_2$ . A calculation of the length,  $L_{mid2}$ , and width,  $W_{mid2}$ , at half basin depth,  $d_2$ , is conducted in order to verify that the length-to-width ratio at half  $d_2$  is greater than 1.5:1.

| <b>Step 7: Determine Dimensions of Cell 2</b>   |               |        |                 |
|---|---------------|--------|-----------------|
| 7-1. Calculate the active volume of Cell 2, $V_2 = V_a - V_1$   | $V_2 =$       | 20,239 | ft <sup>3</sup> |
| 7-2. Calculate the surface area of the active volume of Cell 2, $A_2 = A_{av} - A_1$  | $A_2 =$       | 6,477  | ft <sup>2</sup> |
| 7-3. Calculate the average depth of the active volume of Cell 2, $d_2 = V_2 / A_2$  | $d_2 =$       | 3      | ft              |
| 7-4. Enter the width of Cell 2, $W_2 = W_1 = W_{av-tot} = L_{berm}$   | $W_2 =$       | 43     | ft              |
| 7-5. Calculate the length of Cell 2, $L_2 = A_2 / W_2$  | $L_2 =$       | 151    | ft              |
| 7-6. Calculate the width of Cell 2 at half of $d_2$ , $W_{mid2} = W_2 - Zd_2$   | $W_{mid2} =$  | 34     | ft              |
| 7-7. Calculate the length of Cell 2 at half of $d_2$ , $L_{mid2} = W_2 - Zd_2$  | $L_{mid2} =$  | 52     | ft              |
| 7-8. Verify that the length-to-width ratio of Cell 2 at half of $d_2$ is at least 1.5:1 with $\geq 2:1$ preferred. If the length-to-width ratio is less than 1.5:1, modify input parameters until a ratio of at least 1.5:1 is achieved. If the input parameters cannot be modified as a result of site constraints, another site for the basin should be chosen, $LW_{mid2} = L_{mid2} / W_{mid2}$ | $LW_{mid2} =$ | 1.6    |                 |

**Step 8: Ensure Design Requirements and Site Constraints are Achieved**

Check design requirements and site constraints. Modify design geometry until requirements are met. If the chosen site for the basin is inadequate to meet the design requirements, choose a new location.

**Step 9: Size Outlet Structure**

Refer to Appendix F for basin outlet structure sizing methodologies and examples. The total drawdown time for the basin should be 48 hours. The outlet structure shall be designed to release the bottom 50% of the detention volume (half-full to empty) over 32 hours, and the top half (full to half-full) in 16 hours. A primary overflow should be sized to pass the peak flow rate from the developed capital design storm.

**Step 10: Determine Emergency Spillway Requirements**

For online basins, an emergency overflow spillway should be sized to pass the capital design storm in order to prevent overtopping of the walls or berms in the event that a blockage of the riser occurs. For offline basins, an emergency spillway or riser should be sized to pass the water quality design storm. For sites where the emergency spillway discharges to a steep slope, an emergency overflow riser, in addition to the spillway should be provided.

## APPENDIX E BASIN OUTLET SIZING EXAMPLES

### Perforated Risers Outlet Sizing Methodology (Figure 2-2)

The following attributes influence the perforated riser outlet sizing calculations:

- Shape of the basin (e.g. trapezoidal)
- Depth and volume of the basin
- Elevation / depth of first row of holes
- Elevation / depth of last row of holes
- Size of perforations
- Number of rows or perforations and number of perforations per row
- Desired draw down time (e.g. 16 hour and 32 hour draw down for top half and bottom half respectively, 48 hour total draw down time)

The governing rate of discharge from a perforated riser structure can be calculated using Equation E-1 below:

$$Q = C_p \frac{2A_p}{3H_s} \sqrt{2gH}^{3/2} \quad \text{(Equation E-1)}$$

Where:

- Q = riser flow discharge (cfs)
- C<sub>p</sub> = discharge coefficient for perforations (use 0.61)
- A<sub>p</sub> = cross-sectional area of all the holes (ft<sup>2</sup>)
- s = center to center vertical spacing between perforations (ft)
- H<sub>s</sub> = distance from s/2 below the lowest row of holes to s/2 above the top row of holes (McEnroe 1988)
- H = effective head on the orifice (measured from center of orifice to water surface)

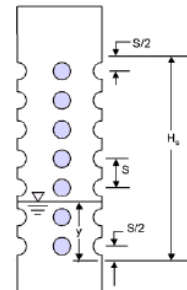

For the iterative computations needed to size the perforations in the riser and determine the riser height a simplified version of Equation E-1 may be used, as shown below in Equation E-2:

$$Q = kH^{3/2} \quad \text{(Equation E-2)}$$

Where:

$$k = C_p \frac{2A_p}{3H_s} \sqrt{2g} \quad \text{(Equation E-3)}$$

Uniformly perforated riser designs are defined by the depth or elevation of the first row of perforations, the length of the perforated section of pipe, and the size or diameter of each perforation. The steps needed to size a perforated riser outlet are outlined below.

Step 1: Determine riser elevation or depth in the basin

Set the riser elevation at 6" above the basin bottom to provide for sediment storage. Select a riser height such that the last row of perforations is in-line with the top of the water quality pool elevation.

Step 2: Determine basin and riser attributes and constants for computations

Parameters examined at this step include basin geometry such as basin shape, basin bottom length and width, and basin side slopes. Organize the attributes obtained in this step in a table such as Table E-1.

Step 3: Determine constant  $k$

Determine the value of the constant  $k$  (Equations E-2 and E-3) that provides the desired draw down time.

Set up a computation table such as Table E-3. Note that the table must have at least 19 height slices or the bottom 5% of the basin shall be combined in the computations. The formulas for each column of the computation table are provided in Table E-2.

Using the basin depth, partition the basin into equal height horizontal slices to be stored as entries in Table E-3. At each elevation  $E_n$  (or table entry), complete the following:

|             |   |                                   |
|-------------|---|-----------------------------------|
|             | Determine the change in elevation $H_n$ (ft)              | $[H_n = (E_o - E_{n+1})]$         |
|             | Calculate the average discharge $Q_n$ (cfs)               | $[Q_n = k(H_n)^{3/2}]$ Eqn E-2    |
|             | Calculate the basin surface area $A_n$ (ft <sup>2</sup> ) | $[A_n = L_n \times W_n$ for       |
| rectangular | basins]   |                                   |
|             | Compute the available storage $V_n$ (ft <sup>3</sup> )    | $[V_n = A_n \times H_n]$          |
|             | Determine the average drain time $T_n$ (hrs)              | $[T_n = (V_n / Q_n) \times 3600]$ |

Sum up the drain times at each height slice to determine the total drain time for the basin. If the value obtained is smaller or greater than the desired value, increase or decrease the  $k$  value and repeat the computations in step b until the desired drain time is achieved.

Step 4: Determine the size and number of rows of perforations

Determine the size and number of rows of perforations that yield a  $k$  value equal to the  $k$  value used in the previous step. Follow the steps below to obtain riser attributes:

Select an initial number of rows, number or holes per row and an initial hole diameter.

Obtain flow area per row values from Table E-4 or compute flow area.

Select a value for  $H_s$  and  $C_p$  and compute  $k$ .

Repeat the above steps varying the number of rows, hole diameter, number of holes per row and  $H_s$  until the desired value of  $k$  is obtained or it is determined that  $k$  is too small to be matched by any realistic combination of inputs. Hole diameter shall not be less than 1/4" to minimize the potential for clogging.

Step 5: Verify the design

The design is completed by verifying that the drain time for both the top half and the bottom half are acceptable and the total drain time is equivalent to the desired value. Note that the drain time for the top half can be obtained by summing the drain times for the top half of the entries in the computation Table E-3. The drain time for the bottom half can similarly be obtained by summing values for the drain times for the bottom half of the entries in the computation Table E-3.

**Table E-1: Constants Used in Example Computations**

| Constant                         | Values  | Units                |
|----------------------------------|---------|----------------------|
| Orifice coefficient ( $C_p$ )    | 0.6     | -                    |
| Perforation diameter (d)         | 0.0468  | ft                   |
| Combined area of holes ( $A_p$ ) | 0.0399  | ft <sup>2</sup>      |
| Acceleration due to gravity (g)  | 32.2    | ft/s <sup>2</sup>    |
| Basin bottom length (L)          | 40      | ft                   |
| Basin bottom width (W)           | 20      | ft                   |
| Side slopes (z)                  | 3       | -                    |
| Basin bottom surface area (A)    | 800     | ft <sup>2</sup>      |
| $k$                              | 0.02791 | ft <sup>3/2</sup> /s |

**Table E-2: Basin Draw Down Time Calculation**

| Line No. | Elev. (ft) | Change in Elevation (ft) | Average Discharge (cfs) | *Basin Surface Area (ft <sup>2</sup> ) | Storage Volume (ft <sup>3</sup> ) | Average Drain Time (hrs) |
|----------|------------|--------------------------|-------------------------|--|-----------------------------------|--------------------------|
| 1        | $E_o$      | $H_o = (E_o - E_1)$      | $Q_o = k(H_o)^{3/2}$    | $A_o = L_o \times W_o$                 | $V_o = A_o \times H_o$            | $T_o = V_o / Q_o$        |
| 2        | $E_1$      | $H_1 = (E_1 - E_2)$      | $Q_1 = k(H_1)^{3/2}$    | $A_1 = L_1 \times W_1$                 | $V_1 = A_1 \times H_1$            | $T_1 = V_1 / Q_1$        |
| 3        | $E_2$      | $H_2 = (E_2 - E_1)$      | $Q_2 = k(H_2)^{3/2}$    | $A_2 = L_2 \times W_2$                 | $V_2 = A_2 \times H_2$            | $T_2 = V_2 / Q_2$        |
| ...      | ...        | ...                      | ...                     | ...                                    | ...                               | ...                      |

\* Basin surface area can be calculated or measured. Non rectangular cross sections must use the appropriate formulas for calculating cross-sectional areas.

**Table E-3: Sample Spread Sheet for Perforated Riser Outlet Sizing Calculations**

| Line No. | Elevation | Change in height | Average Flow at Elev. (top orifice only) | Basin Surface Area | Storage Volume | Time to Drain Unit at Current |
|----------|-----------|------------------|--|--------------------|----------------|-------------------------------|
|----------|-----------|------------------|--|--------------------|----------------|-------------------------------|

|                      |                           |   |                                       |                                      |   | Flow   |
|----------------------|---------------------------|---|---------------------------------------|--------------------------------------|---|--|
|                      | [E <sub>n</sub> ]<br>(ft) | [E <sub>n</sub> - E <sub>n+1</sub> ]<br>H <sub>n</sub> (ft) | [See Eqn E-2]<br>Q <sub>n</sub> (cfs) | A <sub>n</sub><br>(ft <sup>2</sup> ) | [A <sub>n</sub> x H <sub>n</sub> ]<br>V <sub>n</sub> (ft <sup>3</sup> ) | [V <sub>n</sub> / Q <sub>n</sub> ]<br>T <sub>n</sub> (hrs) |
| 1                    | 6                         | 0.3   | 0.4102                                | 4256                                 | 1419  | 1.0  |
| 2                    | 5.7                       | 0.3   | 0.3765                                | 3996                                 | 1332  | 1.0  |
| 3                    | 5.3                       | 0.3   | 0.3438                                | 3744                                 | 1248  | 1.0  |
| 4                    | 5.0                       | 0.3   | 0.3120                                | 3500                                 | 1167  | 1.0  |
| 5                    | 4.7                       | 0.3   | 0.2814                                | 3264                                 | 1088  | 1.1  |
| 6                    | 4.3                       | 0.3   | 0.2518                                | 3036                                 | 1012  | 1.1  |
| 7                    | 4.0                       | 0.3   | 0.2233                                | 2816                                 | 939   | 1.2  |
| 8                    | 3.7                       | 0.3   | 0.1960                                | 2604                                 | 868   | 1.2  |
| 9                    | 3.3                       | 0.3   | 0.1699                                | 2400                                 | 800   | 1.3  |
| 10                   | 3.0                       | 0.3   | 0.1450                                | 2204                                 | 735   | 1.4  |
| 11                   | 2.7                       | 0.3   | 0.1215                                | 2016                                 | 672   | 1.5  |
| 12                   | 2.3                       | 0.3   | 0.0995                                | 1836                                 | 612   | 1.7  |
| 13                   | 2.0                       | 0.3   | 0.0789                                | 1664                                 | 555   | 2.0  |
| 14                   | 1.7                       | 0.3   | 0.0601                                | 1500                                 | 500   | 2.3  |
| 15                   | 1.3                       | 0.3   | 0.0430                                | 1344                                 | 448   | 2.9  |
| 16                   | 1.0                       | 0.3   | 0.0279                                | 1196                                 | 399   | 4.0  |
| 17                   | 0.7                       | 0.3   | 0.0152                                | 1056                                 | 352   | 6.4  |
| 18                   | 0.3                       | 0.3   | 0.0054                                | 924                                  | 308   | 15.9   |
| 19                   | 0.0                       | 0.0   | 0.0000                                | 800                                  | 0   | 0.0  |
| Total Draw Down Time |                           |   |                                       |                                      |   | 48   |

**Table E-4: Circular Perforation Sizing for Perforated Riser.**

| Hole Dia<br>(in) *                    | Hole Dia<br>(in) | Min. S <sub>c</sub><br>(in) | Area per Row (sq in) |      |      |
|---------------------------------------|------------------|-----------------------------|----------------------|------|------|
|                                       |                  |                             | n=1                  | n=2  | n=3  |
| 1/4                                   | 0.250            | 1                           | 0.05                 | 0.10 | 0.15 |
| 5/16                                  | 0.313            | 2                           | 0.08                 | 0.15 | 0.23 |
| 3/8                                   | 0.375            | 2                           | 0.11                 | 0.22 | 0.33 |
| 7/16                                  | 0.438            | 2                           | 0.15                 | 0.30 | 0.45 |
| 1/2                                   | 0.500            | 2                           | 0.20                 | 0.39 | 0.59 |
| 9/16                                  | 0.563            | 3                           | 0.25                 | 0.50 | 0.75 |
| 5/8                                   | 0.625            | 3                           | 0.31                 | 0.61 | 0.92 |
| 11/16                                 | 0.688            | 3                           | 0.37                 | 0.74 | 1.11 |
| 3/4                                   | 0.750            | 3                           | 0.44                 | 0.88 | 1.33 |
| 13/16                                 | 0.813            | 3                           | 0.52                 | 1.04 | 1.56 |
| 7/8                                   | 0.875            | 3                           | 0.60                 | 1.20 | 1.80 |
| 15/16                                 | 0.938            | 3                           | 0.69                 | 1.38 | 2.07 |
| 1                                     | 1.000            | 4                           | 0.79                 | 1.57 | 2.36 |
| 1 1/16                                | 1.063            | 4                           | 0.89                 | 1.77 | 2.66 |
| 1 1/8                                 | 1.125            | 4                           | 0.99                 | 1.99 | 2.98 |
| 1 3/16                                | 1.188            | 4                           | 1.11                 | 2.22 | 3.32 |
| 1 1/4                                 | 1.250            | 4                           | 1.23                 | 2.45 | 3.68 |
| 1 5/16                                | 1.313            | 4                           | 1.35                 | 2.71 | 4.06 |
| 1 3/8                                 | 1.375            | 4                           | 1.48                 | 2.97 | 4.45 |
| 1 7/16                                | 1.438            | 4                           | 1.62                 | 3.25 | 4.87 |
| 1 1/2                                 | 1.500            | 4                           | 1.77                 | 3.53 | 5.30 |
| 1 9/16                                | 1.563            | 4                           | 1.92                 | 3.83 | 5.75 |
| 1 5/8                                 | 1.625            | 4                           | 2.07                 | 4.15 | 6.22 |
| 1 11/16                               | 1.688            | 4                           | 2.24                 | 4.47 | 6.71 |
| 1 3/4                                 | 1.750            | 4                           | 2.41                 | 4.81 | 7.22 |
| 1 13/16                               | 1.813            | 4                           | 2.58                 | 5.16 | 7.74 |
| 1 7/8                                 | 1.875            | 4                           | 2.76                 | 5.52 | 8.28 |
| 1 15/16                               | 1.938            | 4                           | 2.95                 | 5.90 | 8.84 |
| 2                                     | 2.000            | 4                           | 3.14                 | 6.28 | 9.42 |
| n = Number of columns of perforations |                  |                             |                      |      |      |

Source: UDFCD, 1999



Multiple Orifice Outlet Sizing Methodology

The following attributes influence multiple orifice outlet sizing calculations:

- Shape of the basin (e.g. trapezoidal)
- Depth and volume of the basin
- Elevation of each orifice
- Desired draw-down time (e.g., 16 hour and 32 hour draw down times for top half and bottom half, respectively, 48 hour draw down time for whole basin )

The rate of discharge from a single orifice can be calculated using Equation E-4 below:

$$Q = CA(2gH)^{0.5} \quad \text{(Equation E-4)}$$

Where:

- Q = orifice flow discharge
- C = discharge coefficient
- A = cross-sectional area of orifice or pipe (ft<sup>2</sup>)
- g = acceleration due to gravity (32.2 ft/s<sup>2</sup>)
- H = effective head on the orifice (measured from center of orifice to water surface)

Multiple orifice designs are defined by the depth (or elevation) and the size (or diameter) of each orifice (Figure 2-1). The steps needed to size a dual orifice outlet are outlined below; multiple orifices may be provided and sized using a similar approach.

Step 1: Determine orifice elevations

For the bottom orifice, set the orifice elevation ( $H_b$ ) at a maximum of 6" above the basin bottom. If the bottom orifice is below the invert of the outlet pipe, then use the outlet pipe invert elevation for orifice calculations.

For the top orifice, set the orifice elevation ( $H_t$ ) at half way to the top of the water quality pool.

Step 2: Determine basin and orifice attributes and constants for computations

Parameters examined at this step include basin geometry such as basin shape, basin bottom length and bottom width and basin side slopes. Organize the attributes obtained in this step in a table such as Table E-5.

Step 3: Determine the required size of the bottom orifice

Set up a computation table such as Table E-6. The formulas for each column of the computation table are provided in Table E-7.

Using the basin depth, partition the basin into equal height horizontal slices to be stored as entries in Table E-6. At each elevation  $E_n$  (or table entry), complete the following:

|             |   |                                   |
|-------------|---|-----------------------------------|
|             | Determine the change in elevation $H_n$ (ft)              | $[H_n = (E_o - E_{n+1})]$         |
|             | Calculate the average discharge $Q_n$ (cfs)               | $[Q_n = CA(2gH_n)^{0.5}]$ Eqn E-4 |
| rectangular | Calculate the basin surface area $A_n$ (ft <sup>2</sup> ) | $[A_n = L_n \times W_n$ for       |
|             | basins]   |                                   |
|             | Compute the available storage $V_n$ (ft <sup>3</sup> ).   | $[V_n = A_n \times H_n]$          |
|             | Determine the average drain time $T_n$ (hrs)              | $[T_n = (V_n / Q_n) \times 3600]$ |

Sum up the drain times at each height slice to determine the total drain time for the bottom half of the basin. If the value obtained is smaller or greater than the desired value, increase or decrease the orifice diameter and repeat the computations in step b above until the desired drain time is achieved

Step 4: Determine the required size of the top orifice

Set up a Table such as Table E-8. The formulas for each column of the computation tables are provided in Table E-7.

At each elevation  $E_n$  complete the following:

|             |   |                                   |
|-------------|---|-----------------------------------|
|             | Determine the change in elevation $H_n$ (ft)                      | $[H_n = (E_n - E_{n+1})]$         |
|             | Calculate the average discharge $Q_n$ (cfs)                       | $[Q_n = CA(2gH_n)^{0.5}]$ Eqn E-4 |
|             | Calculate the combine average discharge $Q_{TOT-n}$               | $[Q_{TOT-n} = Q_n + Q_b]$         |
| rectangular | Calculate the basin surface area $A_n$ (ft <sup>2</sup> )         | $[A_n = L_n \times W_n$ for       |
|             | basins]   |                                   |
|             | Compute the available storage $V_n$ (ft <sup>3</sup> )            | $[V_n = A_n \times H_n]$          |
|             | Determine the average drain time $T_n$ (hrs)                      | $[T_n = V_n / Q_i]$               |
|             | Note that $Q_b$ is the maximum discharge from the bottom orifice. |                                   |

Sum up the drain times at each height slice to determine the total drain time for the top half of the basin. If the value obtained is smaller than the desired value, increase or decrease the orifice diameter and repeat the computations in step 4b until the desired drain time is achieved.

Step 5: Verify the design

The design is completed by verifying that the sum of the detention times for the top half of the basin and the bottom half of the basin add up to the total desired detention time (36 to 48 hours).

**Table E-5: Constants Used in Example Computations**

| Constant                         | Lower Orifice Values | Upper Orifice Values | Units             |
|----------------------------------|----------------------|----------------------|-------------------|
| Orifice coefficient ( $C_p$ )    | 0.6                  | 0.6                  | -                 |
| Orifice diameter (d)             | 0.0633               | 0.0675               | ft                |
| Orifice cross-sectional area (a) | 0.003                | 0.004                | ft <sup>2</sup>   |
| Acceleration due to gravity (g)  | 32.2                 | 32.2                 | ft/s <sup>2</sup> |
| Basin bottom length (L)          | 40                   | 40                   | ft                |
| Basin bottom width (W)           | 20                   | 20                   | ft                |
| Side slopes (z)                  | 3                    | 3                    | -                 |
| Basin bottom surface area (A)    | 800                  | 800                  | ft <sup>2</sup>   |

**Table E-6: Sample Spreadsheet for Dual Orifice Basin Outlet Sizing Calculations: Bottom Half of Basin**

| Line Number             | Elevation [E] | Change in height  | Average Discharge at Elevation, E (bottom orifice only) | Basin Surface Area | Available Storage Volume | Average Drawdown Time at Current Flow Rate |
|-------------------------|---------------|-------------------|---|--------------------|--------------------------|--|
|                         |               | $[E_n - E_{n+1}]$ | [See Eqn E-4]   | $A_n$              | $[A_n \times H_n]$       | $[V_n / Q_n]$                              |
|                         | (ft)          | $H_n$ (ft)        | $Q_n$ (cfs)   | (ft <sup>2</sup> ) | $V_n$ (ft <sup>3</sup> ) | $T_n$ (hrs)                                |
| 1                       | 3.0           | 3.0               | 0.0567  | 2204               | 735                      | 3.6  |
| 2                       | 2.7           | 2.7               | 0.0534  | 2016               | 672                      | 3.5  |
| 3                       | 2.3           | 2.3               | 0.0500  | 1836               | 612                      | 3.4  |
| 4                       | 2.0           | 2.0               | 0.0463  | 1664               | 555                      | 3.3  |
| 5                       | 1.7           | 1.7               | 0.0422  | 1500               | 500                      | 3.3  |
| 6                       | 1.3           | 1.3               | 0.0378  | 1344               | 448                      | 3.3  |
| 7                       | 1.0           | 1.0               | 0.0327  | 1196               | 399                      | 3.4  |
| 8                       | 0.7           | 0.7               | 0.0267  | 1056               | 352                      | 3.7  |
| 9                       | 0.3           | 0.3               | 0.0189  | 924                | 308                      | 4.5  |
| 10                      | 0.0           | 0.0               | 0.0000  | 800                | 0                        | 0.0  |
| Subtotal Draw Down Time |               |                   |   |                    | 32.0                     |  |

**Table E-7: Basin Draw Down Time Calculation**

| Line No. | Elev (ft) | Change in Elevation (ft) | Average Discharge at Elevation, E (top orifice only) (cfs) | *Combined Average Discharge (cfs) | **Basin Surface Area (ft <sup>2</sup> ) | Storage Volume (ft <sup>3</sup> ) | Average Drain Time (hrs) |
|----------|-----------|--------------------------|--|-----------------------------------|---|-----------------------------------|--------------------------|
| 1        | $E_0$     | $H_0 = (E_0 - E_1)$      | $Q_0 = CA(2gH_0)^{0.5}$                                    | $Q_{TOT-0} = Q_0 + Q_b$           | $A_0 = L_0 \times W_0$                  | $V_0 = A_0 \times H_0$            | $T_0 = V_0 / Q_0$        |
| 2        | $E_1$     | $H_1 = (E_1 - E_2)$      | $Q_1 = CA(2gH_1)^{0.5}$                                    | $Q_{TOT-1} = Q_1 + Q_b$           | $A_1 = L_1 \times W_1$                  | $V_1 = A_1 \times H_1$            | $T_1 = V_1 / Q_1$        |
| 3        | $E_2$     | $H_2 = (E_2 - E_1)$      | $Q_2 = CA(2gH_2)^{0.5}$                                    | $Q_{TOT-2} = Q_2 + Q_b$           | $A_2 = L_2 \times W_2$                  | $V_2 = A_2 \times H_2$            | $T_2 = V_2 / Q_2$        |
| ...      | ...       | ...                      | ...  | ...                               | ...                                     | ...                               | ...                      |

\*  $Q_b$  is the maximum discharge from the bottom orifice.

\*\* Basin surface area can be calculated or measured. Non-rectangular cross sections must use the appropriate formulas for calculating cross-sectional areas.

**Table E-H-8: Sample Spreadsheet for Dual Orifice Basin Outlet Sizing Calculations: Top Half of Basin**

| Line Number             | Elevation | Change in height  | Average Flow at Elevation, E (top orifice only) | Combined Average Discharge | Basin Surface Area | Storage Volume           | Time to Drain Unit at Current Flow |
|-------------------------|-----------|-------------------|---|----------------------------|--------------------|--------------------------|------------------------------------|
|                         | [E]       | $[E_n - E_{n+1}]$ | [See Eqn E-4]                                   | $[Q_n + Q_b]$              | $A_n$              | $[A_n \times H_n]$       | $[V_n / Q_n]$                      |
|                         | (ft)      | H (ft)            | $Q_n$ (cfs)                                     | $Q_{TOT-n}$ (cfs)          | (ft <sup>2</sup> ) | $V_n$ (ft <sup>3</sup> ) | $T_n$ (hrs)                        |
| 1                       | 6.0       | 3.0               | 0.1615  | 0.2181                     | 4256               | 1419                     | 1.8                                |
| 2                       | 5.7       | 2.7               | 0.1522  | 0.2089                     | 3996               | 1332                     | 1.8                                |
| 3                       | 5.3       | 2.3               | 0.1424  | 0.1990                     | 3744               | 1248                     | 1.7                                |
| 4                       | 5.0       | 2.0               | 0.1318  | 0.1885                     | 3500               | 1167                     | 1.7                                |
| 5                       | 4.7       | 1.7               | 0.1203  | 0.1770                     | 3264               | 1088                     | 1.7                                |
| 6                       | 4.3       | 1.3               | 0.1076  | 0.1643                     | 3036               | 1012                     | 1.7                                |
| 7                       | 4.0       | 1.0               | 0.0932  | 0.1499                     | 2816               | 939                      | 1.7                                |
| 8                       | 3.7       | 0.7               | 0.0761  | 0.1328                     | 2604               | 868                      | 1.8                                |
| 9                       | 3.3       | 0.3               | 0.0538  | 0.1105                     | 2400               | 800                      | 2.0                                |
| 10                      | 3.0       | 0.0               | 0.0000  | 0.0567                     | 2204               | 0                        | 0.0                                |
| Subtotal Draw Down Time |           |                   |   |                            |                    |                          | 16.0                               |
| Total Draw Down Time    |           |                   |   |                            |                    |                          | 48.0                               |

## APPENDIX F FLOW SPLITTER DESIGN SPECIFICATIONS

Flow splitters must be provided for off-line facilities to divert the water quality design flow to the BMP and bypass higher flows. In most cases, it is a designer's choice whether storm water treatment BMPs described in this manual are designed as on-line or off-line; exceptions are vegetated strip filters, permeable pavement, and building BMPs which are designed on-line.

A crucial factor in designing flow splitters is to ensure that low flows are delivered to the treatment facility up to the water quality design flow rate. Above this rate, additional flows remain in the storm drain or are diverted to a bypass drain with minimal increase in head at the flow splitter structure to avoid surcharging the water quality facility under high flow conditions.

Flow splitters are typically manholes or vaults with baffles. In place of baffles, the splitter mechanism may be a half tee section with a solid top and an orifice in the bottom of the tee section. A full tee option may also be used (see "Design Criteria" below). Two possible design options for flow splitters are shown in Figures F1 and F2. Other equivalent designs that achieve the result of splitting low flows, up to the WQ design flow, into the WQ treatment facility and divert higher flows around the facility are also acceptable.

Flow splitters may be modeled using standard level pool routing techniques, as described in the Handbook of Applied Hydrology (Ven te Chow; 1964) and elsewhere. The stage/discharge relationship of the outflow pipes shall be determined using backwater analysis techniques. Orifices, if used, may be designed using the approach outlined in "Outlet Structure and Drawdown Time" in the Dry Extended Detention Basin Section 6.10.3. Weirs shall be analyzed as sharp-crested weirs.

### Design Criteria

A flow splitter shall be designed to deliver the required water quality design flow rate to the storm water treatment facility.

The top of the weir shall be located at the water surface for the design flow. Remaining flows enter the bypass line.

The maximum head shall be minimized for flow in excess of the water quality design flow. Specifically, flow to the treatment facility at the capital storm water surface shall not increase the design water quality design flow by more than 10%.

Example designs are shown in Figure F1 and Figure F2. Equivalent designs are also acceptable.

Special applications, such as roads, may require the use of a modified flow splitter. The baffle wall may be fitted with a notch and adjustable weir plate to proportion runoff volumes other than high flows.

For ponding facilities, backwater effects must be included in designing the height of the standpipe in the manhole.

Ladder or step and handhold access shall be provided. If the weir wall is higher than 36 inches, two ladders, on the either side of the wall, are required.

### **Material Requirements**

The splitter baffle shall be installed in a standard manhole or vault. The baffle wall shall be made of material resistant to corrosion (minimum 4-inch thick reinforced concrete, Type 302 or Type 316 stainless steel plate, or equivalent).

The minimum clearance between the top of the baffle wall and the bottom of the manhole or vault cover shall be 4 feet; otherwise, dual access points shall be provided.

All metal parts shall be corrosion resistant. Examples of preferred materials include aluminum, stainless steel, and plastic. Zinc and galvanized materials are not permitted because of aquatic toxicity. Painting metal parts shall not be allowed because of poor longevity.

Figure F-10: Flow Splitter - Option A

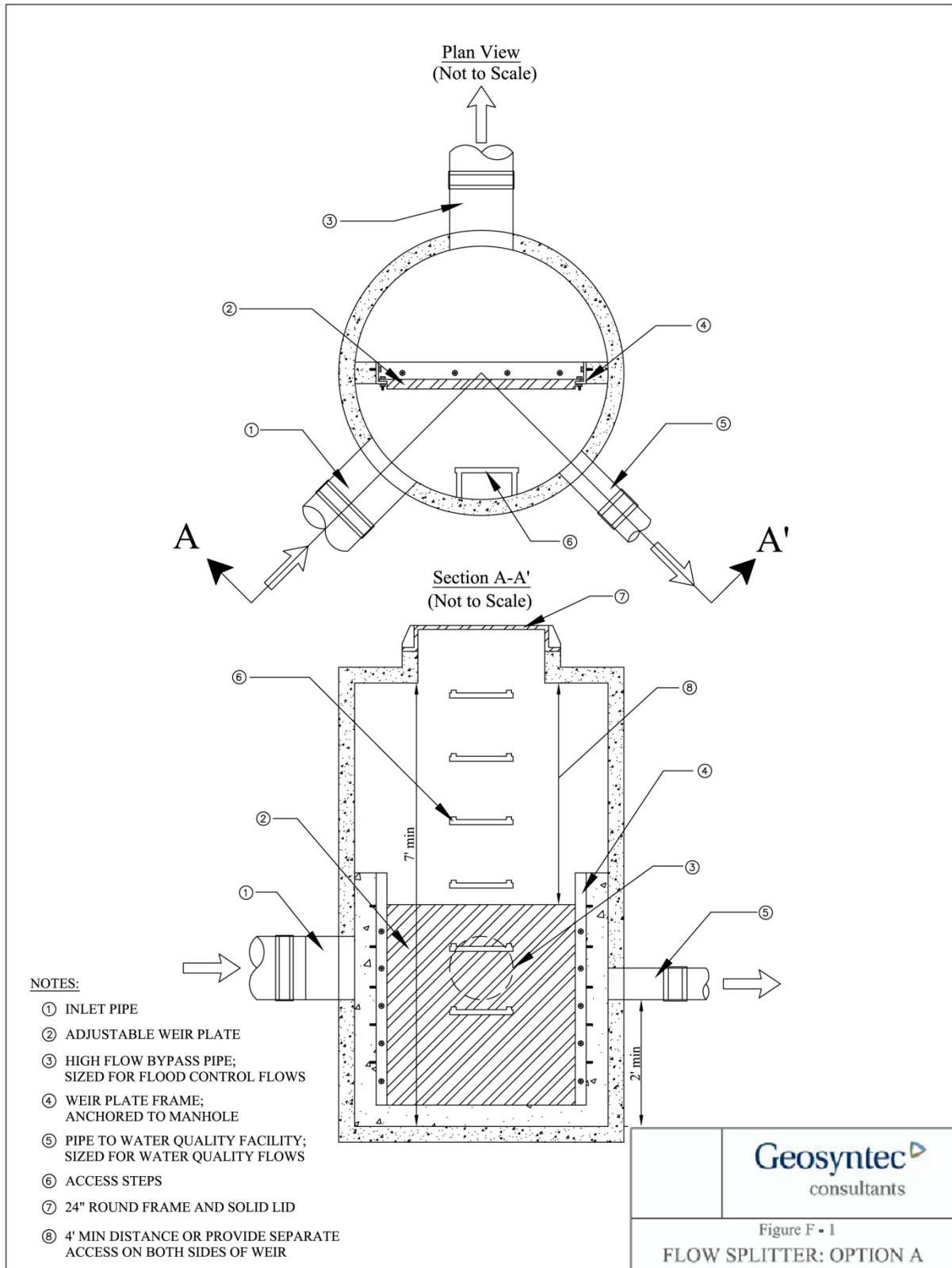
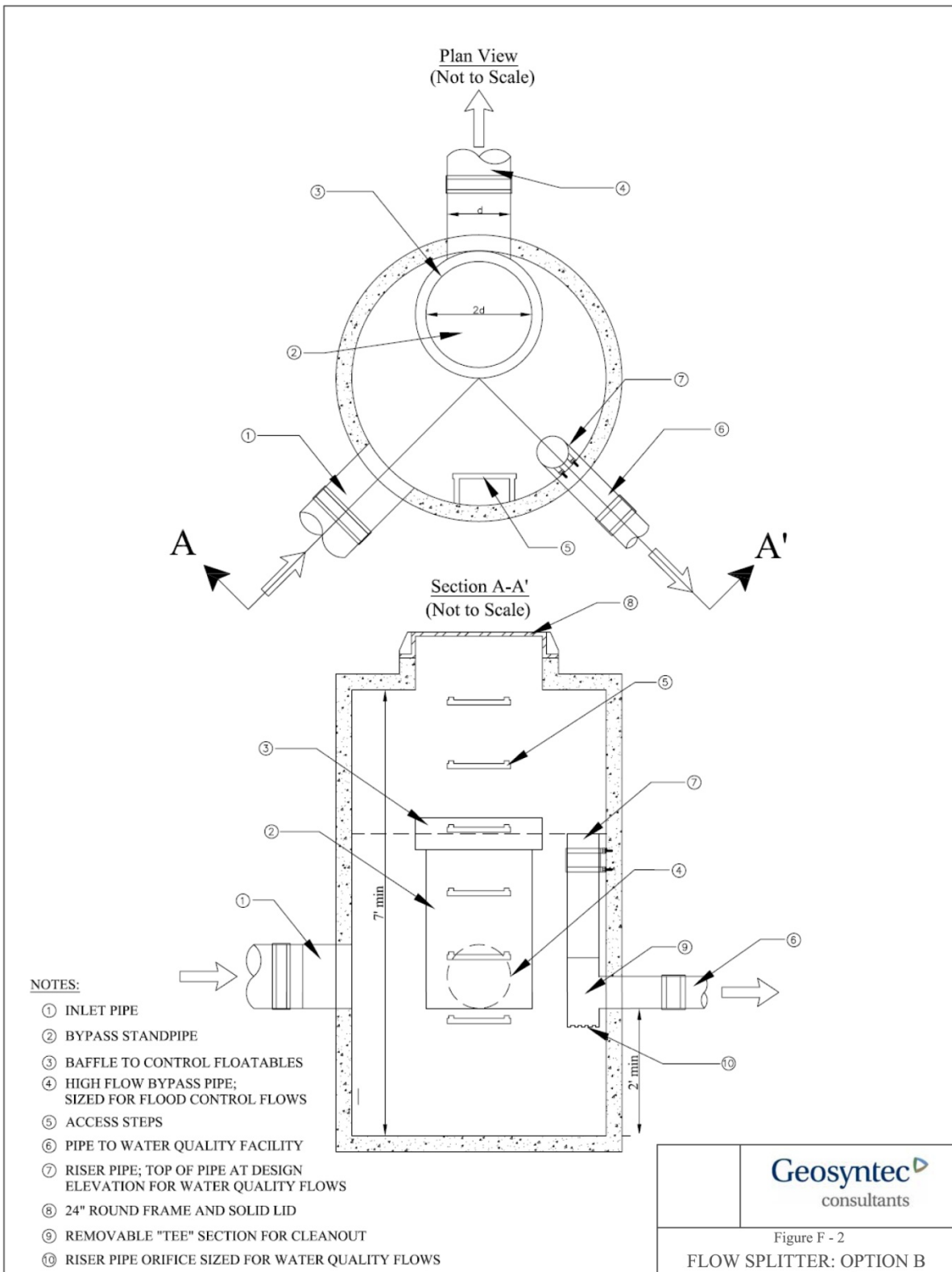

Figure F-11: Flow Splitter - Option B





## APPENDIX G LOCAL PLANT LIST

### PLANT LIST RECOMMENDATIONS

#### Green Roofs

**Note:** The following list is from the *Green Roofs – Cooling Los Angeles: Resource Guide* and provides vegetated roof plants applicable to Santa Barbara. For more information visit, [http://www.fypower.org/pdf/LA\\_GreenRoofsResourceGuide.pdf](http://www.fypower.org/pdf/LA_GreenRoofsResourceGuide.pdf). For *roof garden* plants, use sun and drought tolerant, self-sustaining native trees, shrubs and ecoroof plants.

| <u>Common Name</u>           | <u>Scientific Name</u>             |
|------------------------------|------------------------------------|
| Gold Tooth Aloe              | <i>Aloe nobilis</i>                |
| Golden Barrel Cactus         | <i>Echinocactus grusonii</i>       |
| Hasse's Dudleya              | <i>Dudleya hassei</i>              |
| Beavertail Prickly Pear      | <i>Opuntia basilaris</i>           |
| Blue-blad Cactus             | <i>Opuntia violacea santa-rita</i> |
| Chalk Dudleya                | <i>Dudleya Pulverulenta</i>        |
| Felt Plant                   | <i>Kalanchoe beharensis</i>        |
| Ice Plant                    | <i>Delosperma cooperii</i>         |
| Lampranthus                  | <i>Lampranthus productus</i>       |
| October Daphne               | <i>Sedum sieboldii</i>             |
| Oscularia                    | <i>Lampranthus deltoids</i>        |
| Purple Stonecrop             | <i>Sedum spathulifolium</i>        |
| White Trailing Ice Plant     | <i>Delosperma Alba</i>             |
| Brown Sedge                  | <i>Carex testacea</i>              |
| Deer Grass                   | <i>Muhlenbergia rigens</i>         |
| Tussock Sedge                | <i>Carex stricta</i>               |
| <i>Many species of agave</i> |                                    |

#### **Bioretention Areas, Rain Gardens, Planter Boxes, Infiltration Basins, Vegetated Swales, Vegetated Filter Strips, and Dry Extended Detention Basins:**

The plants listed in this section include native plantings that are suitable for areas that will receive short periods of inundation (e.g. 24 to 72 hours) as well as plants suitable for upland areas.

#### ***Native Plantings – Trees (Can Handle Short Periods of Inundation)***

| <u>Common Name</u>  | <u>Scientific Name</u>   |
|---------------------|--------------------------|
| Western Sycamore    | <i>Platanus racemosa</i> |
| Freemont Cottonwood | <i>Populus fremontii</i> |
| Boxelder            | <i>Acer negundo</i>      |
| Coast Live Oak      | <i>Quercus agrifolia</i> |

***Native Plantings – Shrubs & Grasses (Can Handle Short Periods of Inundation)***

| <u>Common Name</u>          | <u>Scientific Name</u>       |
|-----------------------------|------------------------------|
| California Sagebrush        | <i>Artemisia californica</i> |
| Mugwort                     | <i>Artemisia douglasiana</i> |
| Clustered Field Sedge       | <i>Carex praegracilis</i>    |
| Salt Grass                  | <i>Distichlis spicata</i>    |
| California Fuschia          | <i>Epilobium canum</i>       |
| California Meadow Barley    | <i>Hordeum bachyantherum</i> |
| Coast Goldenbush            | <i>Isocoma manzeisii</i>     |
| Mexican Rush                | <i>Juncus mexicanus</i>      |
| Common Rush                 | <i>Juncus patens</i>         |
| Creeping Rye Grass          | <i>Leymus triticoides</i>    |
| Deerweed                    | <i>Lotus scoparius</i>       |
| Coastal Bush Lupine         | <i>Lupinus arboreus</i>      |
| Sticky Monkey Flower        | <i>Mimulus aurantiacus</i>   |
| Fuschia-flowered Gooseberry | <i>Ribes speciosum</i>       |
| California Rose             | <i>Rosa californica</i>      |
| Blackberry                  | <i>Rubus ursinus</i>         |
| Arroyo Willow               | <i>Salix lasiolepis</i>      |
| Yerba Buena                 | <i>Satureja douglasii</i>    |
| Snowberry                   | <i>Symphoricarpus mollis</i> |
| Verbena                     | <i>Verbena lasiostachya</i>  |

***Upper Bank – Native Shrubs (Generally Suitable for Upland Areas)***

| <u>Common Name</u>    | <u>Scientific Name</u>         |
|-----------------------|--------------------------------|
| California Sagebrush  | <i>Artemisia californica</i>   |
| Coyote Bush           | <i>Baccharis pilularis</i>     |
| Monkeyflower          | <i>Diplacus duranliucus</i>    |
| Giant Ryegrass        | <i>Elymus condensatus</i>      |
| Wild Rye              | <i>Leymus triticoides</i>      |
| Catalina Cherry       | <i>Prunus lyonii</i>           |
| Toyon                 | <i>Heteromeles arbutifolia</i> |
| Lemonade Berry        | <i>Rhus integrifolia</i>       |
| Purple Needle Grass   | <i>Nassella pulchra</i>        |
| Barkberry             | <i>Berberis nenenii</i>        |
| California Blackberry | <i>Rubis urnsinus</i>          |
| Mugwort               | <i>Artemesia douglasii</i>     |

**Wet Retention Basins and Constructed Treatment Wetlands:**

The plants in this section include obligate and facultative wetland plants that generally need saturated conditions for most of the year for survival. The plants listed above that are suitable for areas that can handle short periods of inundation and upland areas may be used along the banks and within the upland areas surrounding the wet retention basins and constructed treatment wetlands.

***Native Wetland – Shrubs***

| <u>Common Name</u>      | <u>Scientific Name</u>                     |
|-------------------------|--|
| Yerba Manza             | <i>Anemopsis californicus</i>              |
| Santa Barbara Sedge     | <i>Carex barbarae</i>                      |
| Common Spike Rush       | <i>Eleocharis macrostachya</i>             |
| Marsh Pennywort         | <i>Hydrocotyle verticillata</i>            |
| Southwestern Spiny Rush | <i>Juncus acutus</i> spp. <i>Leopoldii</i> |
| Water Lily              | <i>Lilium pardolinum</i>                   |
| Bull Rush               | <i>Scirpus maritimus</i>                   |
| Bull Rush               | <i>Scirpus californica</i>                 |
| Dwarf Bulrush           | <i>Scirpus cernuus</i>                     |
| Common Rush             | <i>Juncus phaeocephalus</i>                |
| Common Rush             | <i>Juncus effuses</i>                      |
| Iris-leaved Rush        | <i>Juncus xiphioides</i>                   |

***Commercial Sources for Native Plant Material***

|                    |              |
|--------------------|--------------|
| San Marcos Growers | 805-683-1561 |
| Las Palitas        | 805-438-5992 |
| El Nativo Growers  | 626-969-8449 |
| Tree of Life       | 949-728-0685 |
| Native Sons        | 805-481-5996 |

**Note:** This list is not all-inclusive and is only up-to-date at the time of this manual's release. If you are interested in being added to this list notify Autumn Malanca at [AMalanca@SantaBarbaraCA.gov](mailto:AMalanca@SantaBarbaraCA.gov). For additional local plant and landscape resources, visit the following websites:

- City of Santa Barbara Water Conservation Program: [www.santabarbaraca.gov/Resident/Water/Water\\_Conservation/WCLandscaping.htm](http://www.santabarbaraca.gov/Resident/Water/Water_Conservation/WCLandscaping.htm)
- El Pueblo Viejo District Guidelines Recommended Plant Materials (Appendix F): [http://www.santabarbaraca.gov/NR/rdonlyres/98B4241F-B4BD-4C2C-99CB-7773A198D6D3/0/EPV\\_PlantLIST\\_intable.pdf](http://www.santabarbaraca.gov/NR/rdonlyres/98B4241F-B4BD-4C2C-99CB-7773A198D6D3/0/EPV_PlantLIST_intable.pdf)
- sbwater.org – Saving Your Water: [www.sbwater.org/yourlandscape.htm](http://www.sbwater.org/yourlandscape.htm)

For additional native plant resources, visit the following websites:

- CalFlora - a database of wild California plants that include plant characteristics and photos: <http://www.calflora.org>

- L.A. River Master Plan Landscaping and Plant Palettes - a guidance document providing a listing of native plant communities in the Los Angeles area that is also applicable to Santa Barbara:  
[http://ladpw.org/wmd/watershed/LA/LAR\\_planting\\_guidelines\\_webversion.pdf](http://ladpw.org/wmd/watershed/LA/LAR_planting_guidelines_webversion.pdf)
- Jepson Online Interchange For California Floristics - a database that provides information on identification, taxonomy, distribution, ecology, relationships, and diversity of California vascular plants: <http://ucjeps.berkeley.edu/interchange.html>
- For a more inclusive list of native nurseries, visit: [www.plantnative.org/nd\\_ca.htm](http://www.plantnative.org/nd_ca.htm)
- For a database of commercial native seed availability in the Southern California, visit: [www.nativeseednetwork.org](http://www.nativeseednetwork.org)

## **APPENDIX H FACILITY INSPECTION AND MAINTENANCE CHECKLISTS**

Included in this appendix are a series of checklists that can be used by both inspectors and maintenance personnel to ensure that observed deficiencies in BMPs are maintained appropriately. The BMP Inspection/Maintenance Checklists are presented in the following order:

1. Bioretention/Planter Box
2. Vegetated Swale Filter
3. Vegetated Filter Strip
4. Sand Filter
5. Infiltration BMPs
6. Permeable Pavement
7. Constructed Treatment Wetland
8. Wet Retention Basin
9. Dry Extended Detention Basin
10. Proprietary Devices

### 1. Bioretention/Planter Box Inspection and Maintenance Checklist

Date: \_\_\_\_\_ Work Order # \_\_\_\_\_

Type of Inspection:    post-storm    annual    routine    post-wet season    pre-wet season

Facility: \_\_\_\_\_ Inspector(s): \_\_\_\_\_

| Defect                        | Conditions When Maintenance Is Needed  | Inspection Result (0, 1, or 2) <sup>†</sup> | Date Maintenance Performed | Comments or Action(s) Taken to Resolve Issue |
|-------------------------------|--|---|----------------------------|--|
| Appearance                    | Untidy   |   |                            |  |
| Trash and Debris Accumulation | Trash, plant litter and dead leaves accumulated on surface.                                    |   |                            |  |
| Vegetation                    | Unhealthy plants and appearance.   |   |                            |  |
| Irrigation                    | Functioning incorrectly (if applicable).   |   |                            |  |
| Inlet                         | Inlet pipe blocked or impeded.   |   |                            |  |
| Splash Blocks                 | Blocks or pads correctly positioned to prevent erosion.  |   |                            |  |
| Overflow                      | Overflow pipe blocked or broken.   |   |                            |  |
| Filter media                  | Infiltration design rate is met (e.g., drains 36-48 hours after moderate - large storm event). |   |                            |  |

<sup>†</sup>Maintenance: Enter 0 if satisfactory, 1 if maintenance is needed and include WO#. Enter 2 if maintenance was performed same day.

## 2. Vegetated Swale Filter Inspection and Maintenance Checklist

Date: \_\_\_\_\_ Work Order # \_\_\_\_\_

Type of Inspection:    post-storm    annual    routine    post-wet season    pre-wet season

Facility: \_\_\_\_\_ Inspector(s): \_\_\_\_\_

| Defect                        | Conditions When Maintenance Is Needed   | Inspection Result (0, 1, or 2)† | Date Maintenance Performed | Comments or Action(s) Taken to Resolve Issue |
|-------------------------------|---|---------------------------------|----------------------------|--|
| Appearance                    | Untidy  |                                 |                            |  |
| Trash and Debris Accumulation | Trash and debris accumulated in the swale.  |                                 |                            |  |
| Vegetation                    | When the grass becomes excessively tall (greater than 10-inches); when nuisance weeds and other vegetation start to take over.                                      |                                 |                            |  |
| Excessive Shading             | Vegetation growth is poor because sunlight does not reach swale. Evaluate vegetation suitability.   |                                 |                            |  |
| Poor Vegetation Coverage      | When vegetation is sparse or bare or eroded patches occur in more than 10% of the swale bottom. Evaluate vegetation suitability.                                    |                                 |                            |  |
| Sediment Accumulation         | Sediment depth exceeds 2 inches or covers more than 10% of design area.   |                                 |                            |  |
| Standing Water                | When water stands in the swale between storms and does not drain freely.  |                                 |                            |  |
| Flow spreader or Check Dams   | Flow spreader or check dams uneven or clogged so that flows are not uniformly distributed through entire swale width.   |                                 |                            |  |
| Constant Baseflow             | When small quantities of water continually flow through the swale, even when it has been dry for weeks and an eroded, muddy channel has formed in the swale bottom. |                                 |                            |  |
| Inlet/Outlet                  | Inlet/outlet areas clogged with sediment and/or debris.   |                                 |                            |  |
| Erosion/ Scouring             | Eroded or scoured swale bottom due to flow channelization, or higher flows. Eroded or rilled side slopes.   |                                 |                            |  |
|                               | Eroded or undercut inlet/outlet structures  |                                 |                            |  |

†Maintenance: Enter 0 if satisfactory, 1 if maintenance is needed and include WO#. Enter 2 if maintenance was performed same day.

### 3. Vegetated Filter Strip Inspection and Maintenance Checklist

Date: \_\_\_\_\_ Work Order # \_\_\_\_\_

Type of Inspection:    post-storm    annual    routine    post-wet season    pre-wet season

Facility: \_\_\_\_\_ Inspector(s): \_\_\_\_\_

| Defect                         | Conditions When Maintenance Is Needed   | Inspection Result (0, 1 or 2) <sup>†</sup> | Date Maintenance Performed | Comments or Action(s) Taken to Resolve Issue |
|--------------------------------|---|--|----------------------------|--|
| Appearance                     | Untidy  |  |                            |  |
| Trash and Debris Accumulation  | Trash and debris accumulated on the filter strip.   |  |                            |  |
| Vegetation                     | When the grass becomes excessively tall (greater than 10-inches); when nuisance weeds and other vegetation starts to take over. |  |                            |  |
| Excessive Shading              | Grass growth is poor because sunlight does not reach swale. Evaluate grass species suitability.                                 |  |                            |  |
| Poor Vegetation Coverage       | When grass is sparse or bare or eroded patches occur in more than 10% of the swale bottom. Evaluate grass species suitability.  |  |                            |  |
| Erosion/Scouring               | Eroded or scoured areas due to flow channelization, or higher flows.  |  |                            |  |
| Sediment Accumulation on Grass | Sediment depth exceeds 2 inches.  |  |                            |  |
| Flow spreader                  | Flow spreader uneven or clogged so that flows are not uniformly distributed through entire filter width.                        |  |                            |  |

<sup>†</sup>Maintenance: Enter 0 if satisfactory, 1 if maintenance is needed and include WO#. Enter 2 if maintenance was performed same day.



### 4. Sand Filter Inspection and Maintenance Checklist

Date: \_\_\_\_\_ Work Order # \_\_\_\_\_

Type of Inspection:    post-storm    annual    routine    post-wet season    pre-wet season

Facility: \_\_\_\_\_ Inspector(s): \_\_\_\_\_

| Defect  | Conditions When Maintenance Is Needed   | Inspection Result (0,1, or 2) † | Date Maintenance Performed | Comments or Action(s) taken to resolve issue |
|---|---|---------------------------------|----------------------------|--|
| Trash & Debris  | Any trash and debris which exceed 5 cubic feet per 1,000 square feet of filter bed area (one standard garbage can). In general, there shall be no visual evidence of dumping.<br>If less than threshold all trash and debris will be removed as part of next scheduled maintenance. |                                 |                            |  |
| Inlet erosion   | Visible evident of erosion occurring near flow spreader outlets.  |                                 |                            |  |
| Slow drain time   | Standing water long after storm has passed (after 24 to 48 hours) and/or flow through the overflow pipes occurs frequently.   |                                 |                            |  |
| Concentrated Flow                                       | Flow spreader uneven or clogged so that flows are not uniformly distributed across the sand filter.   |                                 |                            |  |
| Appearance of poisonous, noxious or nuisance vegetation | Excessive grass and weed growth. Noxious weeds, woody vegetation establishing, Turf growing over rock filter  |                                 |                            |  |
| Standing Water  | Standing water long after storm has passed (after 24 to 48 hours), and/or flow through the overflow pipes occurs frequently.  |                                 |                            |  |
| Tear in Filter Fabric                                   | When there is a visible tear or rip in the filter fabric allowing water to bypass the fabric.   |                                 |                            |  |
| Pipe Settlement   | If piping has visibly settled more than 1 inch.   |                                 |                            |  |
| Filter Media  | Drawdown of water through the media takes longer than 1 hour and/or overflow occurs frequently.   |                                 |                            |  |
| Short Circuiting  | Flows do not properly enter filter cartridges.  |                                 |                            |  |

†Maintenance: Enter 0 if satisfactory, 1 if maintenance is needed and include WO#. Enter 2 if maintenance was performed same day.

### 5. Infiltration BMP Inspection and Maintenance Checklist

Date: \_\_\_\_\_ Work Order # \_\_\_\_\_

Type of Inspection:    post-storm    annual    routine    post-wet season    pre-wet season

Facility: \_\_\_\_\_ Inspector(s): \_\_\_\_\_

| Defect                        | Conditions When Maintenance Is Needed   | Inspection Result (0,1, or 2) † | Date Maintenance Performed | Comments or Action(s) Taken to Resolve Issue |
|-------------------------------|---|---------------------------------|----------------------------|--|
| Appearance, vegetative health | Mowing and trimming vegetation is needed to prevent establishment of woody vegetation, and for aesthetic and vector reasons.  |                                 |                            |  |
| Vegetation                    | Poisonous or nuisance vegetation or noxious weeds.  |                                 |                            |  |
|                               | Excessive loss of turf or ground cover (if applicable).   |                                 |                            |  |
| Trash & Debris                | Trash and debris > 5 cf/1,000 sf (one standard size garbage can).   |                                 |                            |  |
| Contaminants and Pollution    | Any evidence of oil, gasoline, contaminants or other pollutants.  |                                 |                            |  |
| Erosion                       | Undercut or eroded areas at inlet or outlet structures.   |                                 |                            |  |
| Sediment and Debris           | Accumulation of sediment, debris, and oil/grease on surface, inflow, outlet or overflow structures.   |                                 |                            |  |
| Sediment and Debris           | Accumulation of sediment and debris, in sediment forebay and pretreatment devices.  |                                 |                            |  |
| Water drainage rate           | Standing water, or by visual inspection of wells (if available), indicates design drain times are not being achieved (i.e., within 72 hours).                                     |                                 |                            |  |
| Media clogging surface layer  | Lift surface layer (and filter fabric if installed) and check for media clogging with sediment (function may be able to be restored by replacing surface aggregate/filter cloth). |                                 |                            |  |
| Media clogging                | Lift surface layer (and filter fabric if installed) and check for media clogging with sediment (partial or complete clogging which may require full replacement).                 |                                 |                            |  |

†Maintenance: Enter 0 if satisfactory, 1 if maintenance is needed and include WO#. Enter 2 if maintenance was performed same day.

### 6. Permeable Pavement Inspection and Maintenance Checklist

Date: \_\_\_\_\_ Work Order # \_\_\_\_\_

Type of Inspection:    post-storm    annual    routine    post-wet season    pre-wet season

Facility: \_\_\_\_\_ Inspector(s): \_\_\_\_\_

| Defect   | Conditions When Maintenance Is Needed   | Inspection Result (0,1, or 2) † | Date Maintenance Performed | Comments or Action(s) taken to resolve issue |
|--|---|---------------------------------|----------------------------|--|
| Sediment Accumulation                            | Sediment is visible   |                                 |                            |  |
| Missing gravel/sand fill                         | There are noticeable gaps in between pavers   |                                 |                            |  |
| Weeds/mosses filling voids                       | Vegetation is growing in/on permeable pavement  |                                 |                            |  |
| Trash and Debris Accumulation                    | Trash and debris accumulated on the permeable pavement.   |                                 |                            |  |
| Dead or dying vegetation in adjacent landscaping | Vegetation is dead or dying leaving bare soil prone to erosion  |                                 |                            |  |
| Surface clog                                     | Clogging is evidenced by ponding on the surface   |                                 |                            |  |
| Overflow clog                                    | <ul style="list-style-type: none"> <li>Excessive build up of water accompanied by observation of low flow in observation well (connected to underdrain system)</li> <li>If a surface overflow system is used, observation of an obvious clog</li> </ul> |                                 |                            |  |
| Visual contaminants and pollution                | Any visual evidence of oil, gasoline, contaminants or other pollutants.   |                                 |                            |  |
| Erosion  | Tributary area <ul style="list-style-type: none"> <li>Exhibits signs of erosion</li> <li>Noticeably not completely stabilized</li> </ul>  |                                 |                            |  |
| Deterioration/ Roughening                        | Integrity of pavement is compromised (i.e., cracks, depressions, crumbling, etc.)   |                                 |                            |  |
| Subsurface Clog                                  | Clogging is evidenced by ponding on the surface and is not remedied by addressing surface clogging.   |                                 |                            |  |

† Maintenance: Enter 0 if satisfactory, 1 if maintenance is needed and include WO#. Enter 2 if maintenance was performed same day.

### 7. Constructed Treatment Wetland Inspection and Maintenance Checklist

Date: \_\_\_\_\_ Work Order # \_\_\_\_\_

Type of Inspection:    post-storm    annual    routine    post-wet season    pre-wet season

Facility: \_\_\_\_\_ Inspector(s): \_\_\_\_\_

| Defect                | Conditions When Maintenance Is Needed   | Inspection Result (0,1, or 2) † | Date Maintenance Performed | Comments or Action(s) taken to resolve issue |
|-----------------------|---|---------------------------------|----------------------------|--|
| Trash & Debris        | Any trash and debris which exceed 5 cubic feet per 1,000 sf of basin area (one standard garbage can). In general, there shall be no visual evidence of dumping.<br><br>If less than threshold all trash and debris will be removed as part of next scheduled maintenance. If trash and debris is observed blocking or partially blocking an outlet structure or inhibiting flows between cells, it shall be removed quickly |                                 |                            |  |
| Sediment Accumulation | Sediment accumulation in basin bottom that exceeds the depth of sediment zone plus 6 inches in the sediment forebay. If sediment is blocking an inlet or outlet, it shall be removed.   |                                 |                            |  |
| Erosion               | Erosion of basin's side slopes and/or scouring of basin bottom.   |                                 |                            |  |
| Oil Sheen on Water    | Prevalent and visible oil sheen.  |                                 |                            |  |
| Noxious Pests         | Visual observations or receipt of complaints of numbers of pests that would not be naturally occurring and could pose a threat to human or aquatic health.  |                                 |                            |  |
| Water Level           | First cell empty, doesn't hold water.   |                                 |                            |  |
| Aesthetics            | Minor vegetation removal and thinning.<br>Mowing berms and surroundings   |                                 |                            |  |
| Noxious Weeds         | Any evidence of noxious weeds.  |                                 |                            |  |

| Defect   | Conditions When Maintenance Is Needed  | Inspection Result (0,1, or 2) † | Date Maintenance Performed | Comments or Action(s) taken to resolve issue |
|--|--|---------------------------------|----------------------------|--|
| Tree Growth  | Tree growth does not allow maintenance access or interferes with maintenance activity (i.e., slope mowing, silt removal, vactoring, or equipment movements). If trees are not interfering, do not remove. Dead, diseased, or dying trees shall be removed. |                                 |                            |  |
| Settling of Berm   | If settlement is apparent. Settling can be an indication of more severe problems with the berm or outlet works. A geotechnical engineer shall be consulted to determine the source of the settlement if the dike/berm is serving as a dam.                 |                                 |                            |  |
| Piping through Berm  | Discernable water flow through basin berm. Ongoing erosion with potential for erosion to continue. A licensed geotechnical engineer shall be called in to inspect and evaluate condition and recommend repair of condition.                                |                                 |                            |  |
| Tree and Large Shrub Growth on Downstream Slope of Embankments | Tree and large shrub growth on downstream slopes of embankments may prevent inspection and provide habitat for burrowing rodents.  |                                 |                            |  |
| Erosion on Spillway  | Rock is missing and soil is exposed at top of spillway or outside slope.   |                                 |                            |  |
| Gate/Fence Damage  | Damage to gate/fence, including missing locks and hinges   |                                 |                            |  |

†Maintenance: Enter 0 if satisfactory, 1 if maintenance is needed and include WO#. Enter 2 if maintenance was performed same day.

### 8. Wet Retention Basin Inspection and Maintenance Checklist

Date: \_\_\_\_\_ Work Order # \_\_\_\_\_

Type of Inspection:    post-storm    annual    routine    post-wet season    pre-wet season

Facility: \_\_\_\_\_ Inspector(s): \_\_\_\_\_

| Defect                | Conditions When Maintenance Is Needed   | Inspection Result (0,1, or 2) † | Date Maintenance Performed | Comments or Action(s) taken to resolve issue |
|-----------------------|---|---------------------------------|----------------------------|--|
| Trash & Debris        | Any trash and debris which exceed 5 cubic feet per 1,000 sf of basin area (one standard garbage can) or if trash and debris is excessively clogging the outlet structure.<br><br>If less than threshold all trash and debris will be removed as part of next scheduled maintenance. |                                 |                            |  |
| Sediment Accumulation | Sediment accumulation in basin bottom that exceeds the depth of the design sediment zone plus 6 inches, usually in the first cell.  |                                 |                            |  |
| Erosion               | Erosion of basin's side slopes and/or scouring of basin bottom.   |                                 |                            |  |
| Oil Sheen on Water    | Prevalent and visible oil sheen.  |                                 |                            |  |
| Noxious Pests         | Visual observations or receipt of complaints of numbers of pests that would not be naturally occurring and could pose a threat to human or aquatic health.  |                                 |                            |  |
| Water Level           | First cell empty, doesn't hold water.   |                                 |                            |  |
| Algae Mats            | Algae mats over more than 20% of the water surface.   |                                 |                            |  |
| Aesthetics            | Minor vegetation removal and thinning.<br>Mowing berms and surroundings   |                                 |                            |  |
| Noxious Weeds         | Any evidence of noxious weeds.  |                                 |                            |  |
| Tree Growth           | Tree growth does not allow maintenance access or interferes with maintenance activity (i.e., slope mowing, silt removal, vactoring, or equipment movements). If trees are not interfering, do not remove. Dead, diseased, or dying trees shall be removed.                          |                                 |                            |  |

| Defect   | Conditions When Maintenance Is Needed  | Inspection Result (0,1, or 2) † | Date Maintenance Performed | Comments or Action(s) taken to resolve issue |
|--|--|---------------------------------|----------------------------|--|
| Settling of Berm   | If settlement is apparent. Settling can be an indication of more severe problems with the berm or outlet works. A geotechnical engineer shall be consulted to determine the source of the settlement if the dike/berm is serving as a dam. |                                 |                            |  |
| Piping through Berm  | Discernable water flow through basin berm. Ongoing erosion with potential for erosion to continue. A licensed geotechnical engineer shall be called in to inspect and evaluate condition and recommend repair of condition.                |                                 |                            |  |
| Tree and Large Shrub Growth on Downstream Slope of Embankments | Tree and large shrub growth on downstream slopes of embankments may prevent inspection and provide habitat for burrowing rodents.  |                                 |                            |  |
| Erosion on Spillway  | Rock is missing and soil is exposed at top of spillway or outside slope.   |                                 |                            |  |
| Gate/Fence Damage  | Damage to gate/fence, including missing locks and hinges   |                                 |                            |  |

†Maintenance: Enter 0 if satisfactory, 1 if maintenance is needed and include WO#. Enter 2 if maintenance was performed same day.

### 9. Dry Extended Detention Basin Inspection and Maintenance Checklist

Date: \_\_\_\_\_ Work Order # \_\_\_\_\_

Type of Inspection:    post-storm    annual    routine    post-wet season    pre-wet season

Facility: \_\_\_\_\_ Inspector(s): \_\_\_\_\_

| Defect                                | Conditions When Maintenance Is Needed   | Inspection Result<br>(0, 1 or 2)† | Date Maintenance Performed | Comments or Action(s) Taken to Resolve Issue |
|---------------------------------------|---|-----------------------------------|----------------------------|--|
| <b>General</b>                        |   |                                   |                            |  |
| Appearance                            | Untidy, un-mown (if applicable)   |                                   |                            |  |
| Vegetation                            | Access problems or hazards; dead or dying trees   |                                   |                            |  |
|                                       | Poisonous or nuisance vegetation or noxious weeds   |                                   |                            |  |
| Insects                               | Insects such as wasps and hornets interfere with maintenance activities.  |                                   |                            |  |
| Rodent Holes                          | Any evidence of rodent holes if facility is acting as a dam or berm, or any evidence of water piping through dam or berm via rodent holes |                                   |                            |  |
| Trash and Debris                      | Trash and debris > 5 cf/1,000 sf (one standard size garbage can).   |                                   |                            |  |
| Pollutants                            | Any evidence of oil, gasoline, contaminants or other pollutants   |                                   |                            |  |
| Inlet/Outlet Pipe                     | Inlet/Outlet pipe clogged with sediment and/or debris. Basin not draining.  |                                   |                            |  |
| Erosion                               | Erosion of the basin's side slopes and/or scouring of the basin bottom that exceeds 2-inches, or where continued erosion is prevalent.    |                                   |                            |  |
| Piping                                | Evidence of or visible water flow through basin berm.   |                                   |                            |  |
| Settlement of Basin Dike/Berm         | Any part of these components that has settled 4-inches or lower than the design elevation, or inspector determines dike/berm is unsound.  |                                   |                            |  |
| Overflow Spillway                     | Rock is missing and/or soil is exposed at top of spillway or outside slope.   |                                   |                            |  |
| Sediment Accumulation in Basin Bottom | Sediment accumulations in basin bottom that exceeds the depth of sediment zone plus 6-inches.   |                                   |                            |  |
| Tree or shrub growth                  | Trees > 4 ft in height with potential blockage of inlet, outlet or spillway; or potential future bank stability problems                  |                                   |                            |  |



| Defect                                     | Conditions When Maintenance Is Needed  | Inspection Result (0, 1 or 2)† | Date Maintenance Performed | Comments or Action(s) Taken to Resolve Issue |
|--|--|--------------------------------|----------------------------|--|
| <b>Debris Barriers (e.g., Trash Racks)</b> |  |                                |                            |  |
| Trash and Debris                           | Trash or debris that is plugging more than 20% of the openings in the barrier.   |                                |                            |  |
| Damaged/ Missing Bars                      | Bars are bent out of shape more than 3 inches.   |                                |                            |  |
|  | Bars are missing or entire barrier missing.  |                                |                            |  |
|  | Bars are loose and rust is causing 50% deterioration to any part of barrier.   |                                |                            |  |
| Inlet/Outlet Pipe                          | Debris barrier missing or not attached to pipe.  |                                |                            |  |
| <b>Fencing</b>                             |  |                                |                            |  |
| Missing or broken parts                    | Any defect in the fence that permits easy entry to a facility.   |                                |                            |  |
| Erosion                                    | Erosion more than 4 inches high and 12-18 inches wide, creating an opening under the fence.  |                                |                            |  |
| Damaged Parts                              | Damage to gate/fence, posts out of plumb, or rails bent more than 6 inches.  |                                |                            |  |
| Deteriorating Paint or Protective Coating  | Part or parts that have a rusting or scaling condition that has affected structural adequacy.  |                                |                            |  |
| <b>Gates</b>                               |  |                                |                            |  |
| Damaged or missing member                  | Missing gate or locking devices, broken or missing hinges, out of plum more than 6 inches and more than 1 foot out of design alignment, or missing stretcher bar, stretcher bands, and ties. |                                |                            |  |

†Maintenance: Enter 0 if satisfactory, 1 if maintenance is needed and include WO#. Enter 2 if maintenance was performed same day.

### 10. Proprietary Device Inspection and Maintenance Checklist

Date: \_\_\_\_\_ Work Order # \_\_\_\_\_

Type of Inspection:  post-storm  annual  routine  post-wet season  pre-wet season

Facility: \_\_\_\_\_ Inspector(s): \_\_\_\_\_

| Defect  | Conditions When Maintenance Is Needed   | Inspection Result (0,1, or 2) † | Date Maintenance Performed | Comments or Action(s) taken to resolve issue |
|---|---|---------------------------------|----------------------------|--|
| <b>Refer to the manufacturer's instructions for maintenance/inspection requirements, below are generic guidelines to supplement manufacturer's recommendations.</b> |   |                                 |                            |  |
| <b>Underground Vault</b>  |   |                                 |                            |  |
| Sediment Accumulation on Media  | Sediment depth exceeds 0.25-inches.   |                                 |                            |  |
| Sediment Accumulation in Vault  | Sediment depth exceeds 6-inches in first chamber.   |                                 |                            |  |
| Trash/Debris Accumulation   | Trash and debris accumulated on compost filter bed.   |                                 |                            |  |
| Sediment in Drain Pipes or Cleanouts  | When drain pipes, clean-outs, become full with sediment and/or debris.  |                                 |                            |  |
| Damaged Pipes   | Any part of the pipes that are crushed or damaged due to corrosion and/or settlement.   |                                 |                            |  |
| Access Cover Damaged/Not Working  | Cover cannot be opened; one person cannot open the cover using normal lifting pressure, corrosion/deformation of cover.   |                                 |                            |  |
| Vault Structure Includes Cracks in Wall, Bottom, Damage to Frame and/or Top Slab  | Cracks wider than 1/2-inch or evidence of soil particles entering the structure through the cracks, or maintenance/inspection personnel determine that the vault is not structurally sound. |                                 |                            |  |
|   | Cracks wider than 1/2-inch at the joint of any inlet/outlet pipe or evidence of soil particles entering through the cracks.   |                                 |                            |  |
| Baffles   | Baffles corroding, cracking warping, and/or showing signs of failure as determined by maintenance/inspection person.  |                                 |                            |  |

| Defect                             | Conditions When Maintenance Is Needed  | Inspection Result (0,1, or 2) † | Date Maintenance Performed | Comments or Action(s) taken to resolve issue |
|------------------------------------|--|---------------------------------|----------------------------|--|
| Access Ladder Damaged              | Ladder is corroded or deteriorated, not functioning properly, not securely attached to structure wall, missing rungs, cracks, or misaligned. |                                 |                            |  |
| <b>Below Ground Cartridge Type</b> |  |                                 |                            |  |
| Filter Media                       | Drawdown of water through the media takes longer than 1 hour and/or overflow occurs frequently.  |                                 |                            |  |
| Short Circuiting                   | Flows do not properly enter filter cartridges.   |                                 |                            |  |

†Maintenance: Enter 0 if satisfactory, 1 if maintenance is needed and include WO#. Enter 2 if maintenance was performed same day.

**APPENDIX I EXAMPLE AGREEMENTS, FORMS, AND LETTERS**

**I.1 Example Storm Water Runoff BMP Access and Maintenance Agreement**

Recorded at the request of: City of Santa Barbara

After recording, return to:

City of \_\_\_\_\_

City Clerk \_\_\_\_\_

**Storm Water Runoff BMP Access and Maintenance Agreement**

**OWNER:** \_\_\_\_\_

**PROPERTY ADDRESS:** \_\_\_\_\_  
\_\_\_\_\_  
\_\_\_\_\_

**APN:** \_\_\_\_\_

**THIS AGREEMENT** is made and entered into in \_\_\_\_\_, California this \_\_\_\_ day of \_\_\_\_\_, by and between \_\_\_\_\_, hereafter referred to as "Owner" and the City of Santa Barbara, a municipal corporation, State of California hereinafter referred to as "**City**";

**WHEREAS**, the Owner owns real property ("Property") in the City of Santa Barbara, State of California, more specifically described in Exhibit "A" and depicted in Exhibit "B", each of which exhibits is attached hereto and incorporated herein by this reference;

**WHEREAS**, at the time of initial approval of development project known as within the Property described herein, the City required the project to employ on-site control measures to minimize pollutants in urban runoff;

**WHEREAS**, the Owner has chosen to install a \_\_\_\_\_, hereinafter referred to as "**Device**", as the on-site control measure to minimize pollutants in urban runoff;

**WHEREAS**, said Device has been installed in accordance with plans and specifications accepted by the City;

**WHEREAS**, said Device, with installation on private property and draining only private property, is a private facility with all maintenance or replacement, therefore, the sole responsibility of the Owner in accordance with the terms of this Agreement;

**WHEREAS**, the Owner is aware that periodic and continuous maintenance, including, but not necessarily limited to, filter material replacement and sediment removal, is required to assure peak performance of Device and that, furthermore, such maintenance activity will require compliance with all Local, State, or Federal laws and regulations, including those pertaining to confined space and waste disposal methods, in effect at the time such maintenance occurs;

**NOW THEREFORE**, it is mutually stipulated and agreed as follows:

1. Owner hereby provides the City or City's designee complete access, of any duration, to the Device and its immediate vicinity at any time, upon reasonable notice, or in the event of emergency, as determined by City's Director of Public Works no advance notice, for the purpose of inspection, sampling, testing of the Device, and in case of emergency, to undertake all necessary repairs or other preventative measures at owner's expense as provided in paragraph 3 below. City shall make every effort at all times to minimize or avoid interference with Owner's use of the Property.
2. Owner shall use its best efforts diligently to maintain the Device in a manner assuring peak performance at all times. All reasonable precautions shall be exercised by Owner and Owner's representative or contractor in the removal and extraction of material(s) from the Device and the ultimate disposal of the material(s) in a manner consistent with all relevant laws and regulations in effect at the time. As may be requested from time to time by the City, the Owner shall provide the City with documentation identifying the material(s) removed, the quantity, and disposal destination.
3. In the event Owner, or its successors or assigns, fails to accomplish the necessary maintenance contemplated by this Agreement, within five (5) days of being given written notice by the City, the City is hereby authorized to cause any maintenance necessary to be done and charge the entire cost and expense to the Owner or Owner's successors or assigns, including administrative costs, attorneys fees and interest thereon at the maximum rate authorized by the Civil Code from the date of the notice of expense until paid in full.
4. The City may require the owner to post security in form and for a time period satisfactory to the city of guarantee the performance of the obligations state herein. Should the Owner fail to perform the obligations under the Agreement, the City may, in the case of a cash bond, act for the Owner using the proceeds from it, or in the case of a surety bond, require the sureties to perform the obligations of the Agreement. As an additional remedy, the Director may withdraw any previous storm water related approval with respect to the property on which a Device has been installed until such time as Owner repays to City its reasonable costs incurred in accordance with paragraph 3 above.
5. This agreement shall be recorded in the [Enter the City department where agreements will be recorded], at the expense of the Owner and shall constitute notice to all successors and assigns of the title to said Property of the obligation herein set forth, and also a lien in such amount as will fully reimburse the City, including interest as herein above set forth, subject to foreclosure in event of default in payment.

6. In event of legal action occasioned by any default or action of the Owner, or its successors or assigns, then the Owner and its successors or assigns agree(s) to pay all costs incurred by the City in enforcing the terms of this Agreement, including reasonable attorney's fees and costs, and that the same shall become a part of the lien against said Property.
  
7. It is the intent of the parties hereto that burdens and benefits herein undertaken shall constitute covenants that run with said Property and constitute a lien there against.
  
8. The obligations herein undertaken shall be binding upon the heirs, successors, executors, administrators and assigns of the parties hereto. The term "Owner" shall include not only the present Owner, but also its heirs, successors, executors, administrators, and assigns. Owner shall notify any successor to title of all or part of the Property about the existence of this Agreement. Owner shall provide such notice prior to such successor obtaining an interest in all or part of the Property. Owner shall provide a copy of such notice to the City at the same time such notice is provided to the successor.
  
9. Time is of the essence in the performance of this Agreement.
  
10. Any notice to a party required or called for in this Agreement shall be served in person, or by deposit in the U.S. Mail, first class postage prepaid, to the address set forth below. Notice(s) shall be deemed effective upon receipt, or seventy-two (72) hours after deposit in the U.S. Mail, whichever is earlier. A party may change a notice address only by providing written notice thereof to the other party.

IF TO COUNTY:

\_\_\_\_\_

\_\_\_\_\_

\_\_\_\_\_

\_\_\_\_\_

IF TO OWNER:

\_\_\_\_\_

\_\_\_\_\_

\_\_\_\_\_

\_\_\_\_\_

**IN WITNESS THEREOF**, the parties hereto have affixed their signatures as of the date first written above.

APPROVED AS TO FORM:

\_\_\_\_\_  
 County Attorney

OWNER:

\_\_\_\_\_  
 Name: \_\_\_\_\_  
 Title: \_\_\_\_\_

COUNTY OF: \_\_\_\_\_

Name: \_\_\_\_\_  
 Title: \_\_\_\_\_

OWNER: \_\_\_\_\_

Name: \_\_\_\_\_  
 Title: \_\_\_\_\_

ATTEST: \_\_\_\_\_

\_\_\_\_\_

County Clerk                  Date

NOTARIES ON FOLLOWING PAGE

EXHIBIT A

(Legal Description)

EXHIBIT B

(Map/Illustration)

**I.2 Example Storm Water Runoff BMP Access and Maintenance Agreement (Short Form)**

(Short Form)

Recorded at the request of and mail to:

\_\_\_\_\_  
\_\_\_\_\_  
\_\_\_\_\_  
\_\_\_\_\_

**Covenant and Agreement Regarding Storm Water Treatment Device Maintenance**

The undersigned hereby certify that we are the owners of hereinafter legally described real property located in the City of \_\_\_\_\_, County of \_\_\_\_\_, State of California.

**Legal Description:** \_\_\_\_\_

\_\_\_\_\_  
as recorded in Book \_\_\_\_\_, Page \_\_\_\_\_, Records of \_\_\_\_\_  
County, which property is located and known as (Address) \_\_\_\_\_

And in consideration of the County of \_\_\_\_\_ allowing \_\_\_\_\_

\_\_\_\_\_ on said property, we do hereby covenant and agree to and with said City to maintain according to the Maintenance Plan (Attachment 1), all structural storm water treatment devices including the following:

This Covenant and Agreement shall run all of the above described land and shall be binding upon ourselves, and future owners, encumbrances, their successors, heirs, or assignees and shall continue in effect until released by the authority of the City upon submittal of request, applicable fees, and evidence that this Covenant and Agreement is no longer required by law.

**NOTARIES ON FOLLOWING PAGE**

EXHIBIT A

(Map/Illustration)



### 1.3 Example Facility Inspection Notification

[Letterhead]

[Address of Facility manager]

**Subject:** Storm Water Management Facility Inspection Notification

**Response requested by:** [Date]

Dear Facilities Manager,

The City of Santa Barbara must ensure that all storm water management facilities in the City are adequately maintained and functioning properly, under terms of Section [XXXXX], City Code. These facilities are crucial components for protecting our streams from erosion and flooding and key factors in improving water quality. By this letter we are notifying you of an inspection between [enter the dates here: mm-dd-yy and mm-dd-yy].

Our records show that you are the owner of:

| Facility No. | Description | Access |
|--------------|-------------|--------|
|              |             |        |
|              |             |        |

By law, the Department of Public Works must notify the owner of any deficiencies that may be found during the inspection. The process will include a visual inspection of the facility, a checklist (template(s) enclosed) and possibly digital photographs.

You will receive a written copy of the inspectors report, including any appropriate suggestions or requirements for maintenance. As [owners of the property] containing private storm water management facilities, you are responsible for the maintenance of the facilities, under Municipal Code [XXXXX]. The code also requires that within 30 days of the receipt of this report, your [company], as property [owner], respond and correct any deficiencies noted in the report or provide proof of intent to make the corrections.

Please provide us, if possible, the name and address of the person within your organization who currently oversees the maintenance of the storm water management facilities. If you have any questions about this process, please call [City representative] of this office at [Phone number].

Sincerely,

[Head]

[Section]

[Division]

**1.4 Example Notice of Violation Letter**

Whereas, \_\_\_\_\_ Home Owners Association (owner) did:

- 1. Fail to maintain storm water management facility [Description] located at [Location] known as storm water facility (Facility ID) in accordance with the Santa Barbara Municipal Code [XXXX] and,
- 2. Receive notice of maintenance deficiencies in a letter date [Date] written by [XXXX] of the Department of Public Works and received by the owners agent [XXXX] and receive notice of deficiencies through the owners agent via telephone and,
- 3. Fail to correct maintenance items within the 30 day time frame specified in the letter date [date] and subsequent verbal compliance time extensions with agent of [date] and [date] and,

**Whereby**, owner and Department of Public Works agreed to meet on [date] to discuss the maintenance items.

By this notice, the owner must:

- Task 1 and,
- Task 2 and,
- Task 3 and,

Comply with this Notice of Violation within 30 days.

**Failure to comply** will result in a Class A Civil Citation in accordance with Section [XXXX] of the Municipal Code with each day representing a separate violation.

Signature implies no guilt but receipt of this Notice of Violation

Signature \_\_\_\_\_ Date \_\_\_\_\_

Name \_\_\_\_\_

President of \_\_\_\_\_ Home Owners Association

\_\_\_\_\_ Date \_\_\_\_\_

Department of Public Works  
[Phone number] [email address]

**1.5 Example Request for Maintenance Form**

[Letterhead]

[Address of Facility manager]

**Subject:** Storm water Management Facility Maintenance Notification

**Response requested by:** [Date]

Dear [Facilities Manager] [Home Owners Association President] [Property Manager],

Our records show that you are the owner of:

| Facility No. | Description | Access |
|--------------|-------------|--------|
|              |             |        |
|              |             |        |

The City of Santa Barbara [through its contractor] has inspected your storm water management structure. A list of necessary maintenance or repairs to the facility as a result of that inspection is attached. The next step in repairing your facility would be to get bids and a scope of work from several contractors and then hire a contractor to perform the necessary work. You may use any contractor that meets the regulatory requirements of the job. [We have compiled a list of contractors as a service because of the numbers of requests we receive for this information. The City does not recommend any contractor.]

Once you have a contractor, you must contact Department of Public Works Inspection Staff, [XXXX] [Phone number] or [YYYYY] [Phone number] to arrange a site visit to discuss the repairs. Then [XXXXX] or [YYYYY] will make a final approval inspection after the repairs are completed.

You will need to contact an engineer or [other qualified person] to prepare site plans [or other documents] for these permits. If you have questions concerning the permitting process, you shall contact the Department of Public Works permitting services at [Phone number].

You have 30 days from receipt of this letter to respond and correct any deficiencies noted in the report or provide proof of intent to make the corrections. We will make every effort to assist you in this process but failure to complete the repairs in the specified time will result in enforcement action being taken against you in accordance with [XXXXX] of the Municipal Code. If you have any questions about this process, please call [City representative] of this office at [Phone number].

Sincerely,

[Head]

[Section]

[Division]

## APPENDIX J LIST OF DISCRETIONARY PROJECTS EXEMPT FROM TIER 3 REQUIREMENTS

(These projects are exempt from the Tier 3 storm water runoff requirements, but some *may be* subject to Tier 2 Basic BMP requirements)

- 2nd story additions (i.e. additions that do not increase the building footprint); treat as Tier 2 if the project is under 4,000 square feet
- Building additions/Site work/repairs/replacements of impervious surfaces that total less than 500 square feet; treat as Tier 2 if a permit is required
- Interior remodel or alteration projects
- Cosmetic improvements/alterations that do not increase the building footprint (i.e. painting, door replacement, window replacement, façade remodel, replastering of a structure, awnings, etc.)
- Disaster rebuilds (with same or smaller building footprint)
- Retaining walls, Fences, Gates, Trellises, Trash enclosures (i.e. vertical structures with impervious surface areas less than 500 square feet)
- Sign installation or repairs
- Electrical/plumbing/mechanical projects with impervious surfaces that total less than 500 square feet
- Raised decks, stairs, or walkways (not built directly on the ground) designed with spaces to allow for water drainage
- Parking lots, walkways, etc. designed to be permeable (permeable concrete or asphalt, permeable pavers, grass pavers, etc.)
- Landscaping projects; treat as Tier 2 if permit is required
- Excavations/demolitions/grading that does not result in 500 square feet or more of developed or redeveloped impervious surface area
- Installing photovoltaic systems
- Reroofing projects involving no increase in roof surfaces; treat as Tier 2 if roof work is over 500 square feet
- Repair permits to structures and/or maintenance activities (“maintenance” defined in Appendix A: Glossary).
- One story accessory building or garage less than 500 square feet
- Addition of chimneys or BBQ areas (assuming hardscape is less than 500 square feet)
- New skylights
- Exterior lighting projects
- Spas/pools less than 500 square feet and/or designed to detain the 1-inch, 24-hour storm
- Temporary structures (temporary = 6 months; non-recurring)
- Electrical and utility vaults, sewer and water lift stations, backflows and other utility devices, with a roof area of less than 500 square feet in size
- Remediation equipment mandated by the County or another governmental agency as part of a site cleanup
- Repair or replacement of airfield paving within Airfield Operations Area (AOA) where there is no expansion of the paved area
- Boat ramps

- Above-ground fuel storage tanks and fuel farms with spill containment systems
- Septic system installation or repairs
- Technical or legal infeasibility (where strict compliance with the City's storm water runoff requirements is found to be infeasible, the project applicant must utilize all feasible measures to achieve the greatest compliance possible)

## **APPENDIX K DART SWMP CHECKLIST**

Checklist begins on next page

D R A F T  
City of Santa Barbara Development Application Review Team (DART)  
Storm Water Management Plan (SWMP)

**DART SWMP CHECKLIST**

Project Address: \_\_\_\_\_ Project Type: \_\_\_\_\_  
MST \_\_\_\_\_ PRT or DART: \_\_\_\_\_  
Date: \_\_\_\_\_ Case Planner: \_\_\_\_\_  
Project Area Acreage: \_\_\_\_\_ Acres Disturbed: \_\_\_\_\_ Slope %: \_\_\_\_\_ Adjacent to Creek Y/N: \_\_\_\_\_

The following design standards and best management practices (BMP) for storm water management are required under National Pollution Discharge Elimination System (NPDES) provisions ( State Regional Water Quality Control Board Phase II General Permit for the City). These measures are included in the City Storm Water Management Plan (SWMP) adopted to implement the NPDES requirements through the City development and redevelopment review and permitting process. The City is required to document to the Regional Board yearly how these measures have been implemented.

As part of a pre-application or application review process for a project discretionary permit by the City, DART members review for project design standards and other BMPs that can feasibly be taken to reduce storm water pollution to the maximum extent practicable.

Identify whether measures on the checklist are applicable, and whether they are applied through a project design revision prior to permit approval, and/or a condition of project approval. If the measure is not feasible, indicate why not.

**1.0 CONSTRUCTION PHASE BEST MANAGEMENT PRACTICES**

**1.1 Erosion and Sedimentation Control (*Building and Safety*)**

- Not applicable. Project does not involve ground disturbance.

---

- Apply Standard Erosion Control Measures as condition (where disturbed soil <1 acre, slope <15%, property not adjacent to creek).

---

- Detailed Erosion Control Plan required (where disturbed soil  $\geq$  1 acre, slope > 15%, property adjacent to creek):
  - \_\_\_ Detailed Plan required as part of DART application. Apply condition requiring plan implementation; or
  - \_\_\_ Apply condition requiring Detailed Plan submittal and approval prior to Building Permit, and plan implementation.

**2.0 POST-CONSTRUCTION BEST MANAGEMENT PRACTICES**

**2.1 Peak Storm Water Run-Off Discharge Rates (*Public Works*)**

- Not applicable. Project involves no/minimal change in permeable surface or peak storm water run-off discharge rate. No BMPs required.

---

- Drainage calculations are required as part of DART application (using County of Santa Barbara hydrograph data and Manning equation). \_\_\_ Drainage calculations are adequate.
- Project design would not increase peak 25-year storm water run-off and would reduce peak storm water run-off discharge rate to the maximum extent practicable, through:
  - \_\_\_ Any increase in run-off will be retained on-site and filtered using structural BMPs such as detention basins, bioswales (vegetated filters), and/or mechanical BMPs such as manufactured filters.  
BMPs \_\_\_\_\_
  - \_\_\_ Increase in water will be retained with underground tanks.
- BMPs will be applied as follows:
  - \_\_\_ Project design as proposed (with condition of approval requiring project implementation as proposed, and ongoing maintenance of BMPs if applicable).
  - \_\_\_ Revised project design submitted as part of the DART process (and application of condition of approval requiring project implementation as revised, and ongoing maintenance of BMPs).

- Application of a condition of approval requiring feasible project design changes and/or other BMPs, and ongoing maintenance of BMPs.

## 2.2 Structural and Treatment Control BMPs (*Public Works, Creeks*)

- Not applicable.

---
- Long-term volumetric treatment control BMP will be incorporated into the project development (design criterion is a 1" storm).

---
- Long-term flow-based treatment control BMP will be applied (design criterion is .25" for four hours).

---
- BMPs will be applied as follows:
  - Project design as proposed (with condition of approval requiring project implementation as proposed and ongoing maintenance of BMPs if applicable).
  - Revised project design submitted as part of the DART process (and application of condition of approval requiring project implementation as revised, and ongoing maintenance of BMPs).
  - Application of a condition of approval requiring feasible project design changes and/or other BMPs, and ongoing maintenance of BMPs.

## 2.3 Minimization of Storm Water Pollutants of Concern (*Creeks, Public Works*)

- Not applicable
- General pollutants/ small projects: Passive, low maintenance BMPs will be applied through minimizing hardscape; vegetative swales, use of permeable paving; and/or detention basin.

---
- Automotive pollutants/ oil, grease, metals: The following BMPs will be applied for projects with 10 or more parking spaces:  Runoff from entrance drive for covered parking will be treated by collecting water in a trench drain and filtering before discharge.  Basement parking garages will provide treatment of any storm water discharged from basement garage to storm drain.  Runoff will be discharged to a vegetated swale or constructed sand filter, or through a manufactured BMP (drain filter or wet-sump filter).

---
- Erosion and Sedimentation/ suspended solids: Projects in hillsides, near creeks, or involving substantial earthwork: BMPs applied for long-term post-construction slope stability and erosion/sedimentation control, such as site layout to avoid  $\geq 15\%$  slopes, adequate setbacks from creeks.

---
- BMPs will be applied as follows:
  - Project design as proposed (with condition of approval requiring project implementation as proposed and ongoing maintenance of BMPs if applicable).
  - Revised project design submitted as part of the DART application process (and condition of approval requiring project implementation as revised, and ongoing maintenance of BMPs).
  - Condition of approval requiring feasible project design changes and/or other BMPs, and ongoing maintenance of BMPs.

## 2.4 Natural Area Conservation BMPs (*Planning*)

- Not applicable.

---
- Development is clustered leaving remaining land in natural condition.

---
- Grading and clearing of native vegetation is limited to amount needed for lots, access, and fire protection.

---
- Trees and vegetation are maximized to the extent feasible, and use of drought-tolerant plants is promoted.

---
- Natural vegetation is promoted through use of parking lot islands and other landscaped areas.

---



- Riparian areas and wetlands are preserved.
- 

- Natural area design standards will be incorporated to the extent applicable and feasible, consistent with City policies, as follows:

- Project design as proposed (with condition of approval requiring project implementation as proposed, and ongoing maintenance of BMPs if applicable).

- Revised project design submitted as part of the DART process (and application of condition of approval requiring project implementation as revised, and ongoing maintenance of BMPs).

- Application of a condition of approval requiring feasible project design changes and/or other BMPs, and ongoing maintenance of BMPs.

## **2.5 Protection of Slopes and Channels (*Planning, Building, Public Works, Creeks*)**

- Not applicable. Project is not adjacent to creek, and does not include substantial slopes.

- The following additional information has been required:

- Existing site conditions: geomorphic, hydraulic, biological, geotechnical; top-of-bank determination.

---

- Proposed project information and plans, potential effects on slopes and channels, and plans/measures to protect slopes/channels (preliminary grading plan; preliminary drainage plan; slope stability, permanent erosion control, vegetation management, preliminary creek restoration and enhancement plan, including protection of biological values such as shade provisions, water temperature maintenance, nutrient filtering, wildlife movement corridors; fish movement; wildlife habitat protection.)

---

- Runoff will be conveyed safely from the toes of slopes and disturbed slopes will be stabilized.
- 

- Natural drainage channels will be used to the maximum extent practicable.
- 

- Permanent channel crossings will be stabilized.
- 

- Slopes will be vegetated with appropriate native or drought-tolerant vegetation.
- 

- Energy dissipaters, such as riprap, will be installed at the outlets of new storm drains, culverts, conduits, or channels that enter unlined channels in accordance with applicable specifications to minimize erosion with the approval of all agencies with jurisdiction.
- 

- The project will incorporate slope and/or channel protection design standards to the extent applicable and feasible, consistent with applicable City policies, as follows:

- Project design as proposed (with condition of approval requiring project implementation as proposed, and ongoing maintenance of BMPs if applicable); or

- Revised project design submitted as part of the DART process (and application of condition of approval requiring project implementation as revised, and ongoing maintenance of BMPs); or

- Condition of approval requiring feasible project design changes and/or other BMPs, and ongoing maintenance of BMPs.

## **2.6 Storm Drain Stenciling and Signage (*Public Works, Building*)**

- Not applicable. No storm drain inlets.

- Condition of approval will be applied that public and private storm drain inlets and catch basins within the project area must be stenciled with language and/or graphic icons prohibiting dumping of improper materials directly into the storm water conveyance system. Signs prohibiting illegal dumping must be posted at public access points along channels and creeks within the project area. Legibility of stenciling and signs must be maintained.

---

## 2.7 Outdoor Material Storage Design *(Planning, Building)*

- Not applicable. No outdoor material storage area.
  - Materials with the potential to pollute storm water will be placed within an enclosure such as cabinet, shed or similar structure that prevents contact with runoff or spillage to the storm water conveyance system, or will be protected by secondary containment structures such as berms, dikes, or curbs. The storage area will be paved and sufficiently impervious to contain leaks and spills. The storage will have a roof or awning to minimize collection of storm water within the secondary containment.
- 
- The project will incorporate BMPs as follows:
    - Project design as proposed incorporates these measures.
    - Revised project design submitted as part of DART review process incorporates these measures.
    - These measures are feasible and will be applied as a condition of permit approval.

## 2.8 Trash Storage Area Design *(Public Works)*

- Not applicable. No trash storage area.
  - Trash containers will have drainage from adjoining roofs and pavement diverted around the areas; and trash container areas will be screened or walled to prevent off-site transport of trash. Individual single family residences may be exempted if determined by City to be infeasible.)
  - The BMPs will be incorporated as follows:
    - Project design as proposed.
    - Revised project design submitted as part of DART review process.
    - These measures are feasible and will be applied as a condition of permit approval.
- 

## 2.9 Ongoing BMP Maintenance *(Planning, Building, Public Works, Creeks)*

- Not applicable. No BMPs are required.
  - Condition will be applied to establish BMP maintenance agreement providing owner ongoing maintenance and yearly inspection.
- 

## 2.10 Design Standards for Specified Individual Project Categories *(Planning, Building, Public Works, Creeks)*; refer to the Design Standards of Attachment 4 of the State General Permit (WQO 2003-0005-DWQ); per City SWMP, all discretionary projects, regardless of size, shall comply with the Design Standards in Attachment 4.

- Not applicable.
  - Commercial Projects: Proper design of loading/unloading dock areas; repair/maintenance bays; vehicle wash areas to protect water quality.
- 
- Restaurants: Proper design of equipment/ accessory wash areas to protect water quality.
- 
- Retail Gasoline Outlets: Proper design of fueling areas to protect water quality.
- 
- Automotive Repair Shops: Proper design of fueling areas; repair/maintenance bays; vehicle/equipment wash areas; and loading/unloading dock areas to protect water quality.
- 
- Parking Lots: Proper design of parking areas to protect water quality; and operational provisions to limit oil contamination.
-

- BMPs will be incorporated as follows:
  - Project design as proposed.
  - Revised project design submitted as part of DART review process.
  - These measures are feasible and will be applied as a condition of permit approval.